



Mallory Sonalert Products, Inc.

Part #: **ZA120MACT**

Sales Outline Drawing

Revision: **A**

Specifications:

Sound Level Category	Medium
Mode of Operation	Continuous
Voltage Rating	48 to 120 VAC/DC
Frequency	3300 ± 500 Hz
Loudness @ 2 FT	75 to 85 dB(A) Typ.
Current Draw	40mA MAX
Housing Material	6/6 Nylon, Color: Black
Storage Temperature	-40° to +55° C
Operating Temperature	-30° to +50° C
Panel Mounting	Recommended hole size is 22.5 mm. Thread front will fit standard 22.5mm hole.
Knurled Nut	Used to attach part to panel. The max recommended torque is 10 in-lbs.
Weight (Typical)	28 g
NEMA 3R,4X, & 12	Approved with use of included gasket.
Options	Please contact factory.

Dimensions: Inches (mm)

cUL Recognized

ROHS Compliant

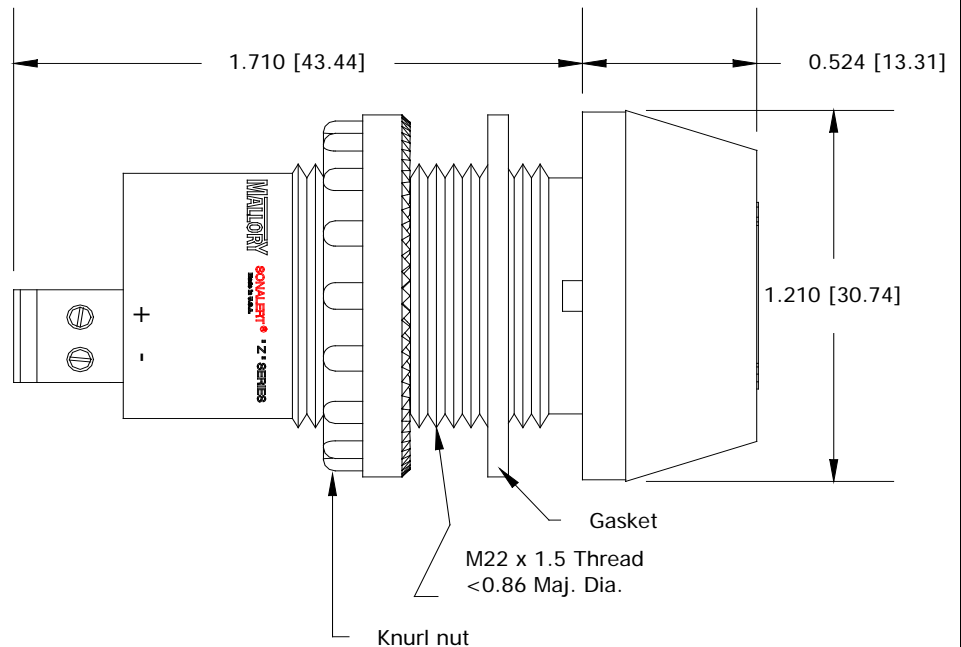
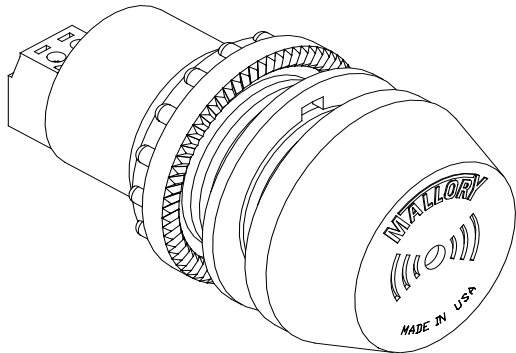

Mounting Instructions:

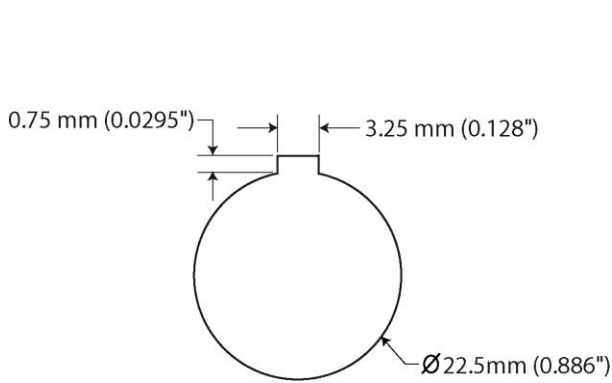

Panel Hole Cut Out

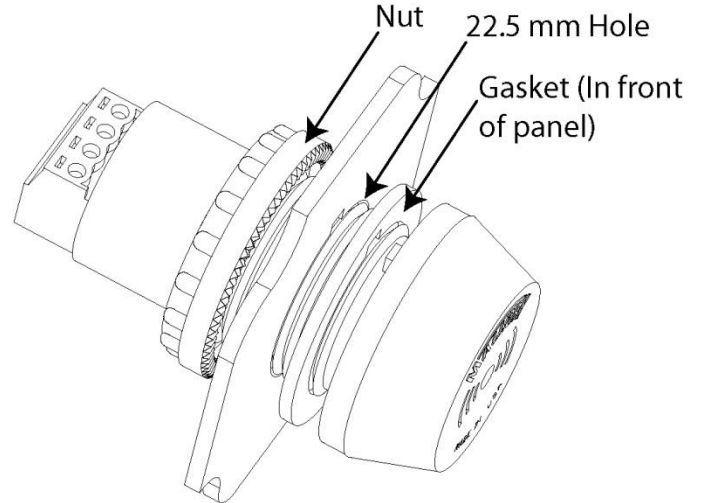

- **Panel Hole Size:** 22.5 mm with Keyway
- **Maximum Panel Thickness:** 12.7 mm (0.5 in)
- **Maximum Nut Torque:** 10 in-lbs (1.13 n-m)

Electrical Connection:

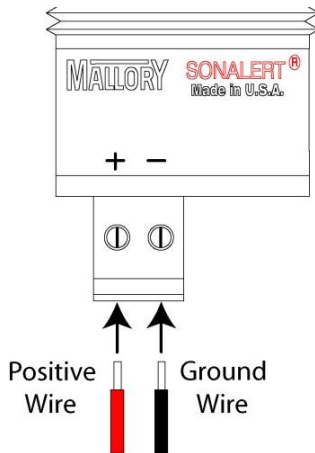

DC
ONLY

AC/DC

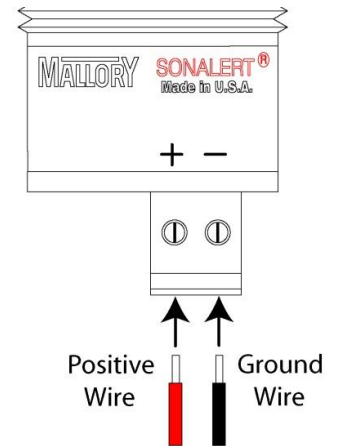

- **Wire Strip Length:** 6.5 mm (0.256 in)
- **Wire Size:** 30 to 16 AWG
- **Maximum Screw Torque:** 2 in-lbs (0.226 n-m)



MALLORY SONALERT PRODUCTS, INC.

ZA Series- 22mm Panel Alarms

Certifications:

- **RoHS; cUL; NEMA 3R/4X/12; IP-66; CSA 22.2 No. 94**
 - Included gasket must be used to maintain NEMA 3R/4X/12 ratings.

cUL Yellow Card:

UL Online Certifications Directory

UCST8.S1290

Audible Signal Appliances, General Signal Certified for Canada - Component

Audible-signal Appliances, General Signal Certified for Canada - Component

MALLORY SONALERT PRODUCTS INC
4411 S HIGH SCHOOL RD
INDIANAPOLIS, IN 46241 USA

S1290

Audible tone generators, ZA aaa b c ddd (f9)

(f9) - Must be used with neoprene gasket type 4216-S to maintain enclosure NEMA Type Ratings 3R, 4X and 12.

aaa - Indicates voltage rating. May be 016, 028, 048 or 120.

b - Indicates sound level. May be L, M or S.

c - Indicates voltage type. May be A or D.

ddd - Indicates Sound Function. May be any combination of letters A through Z and/or numbers 0 through 9.

Marking: Company name or tradename "Mallory" , "Sonalert" , model designation and Recognized Component Mark for Canada, 

Last Updated on 2012-02-03



ZA Series- 22mm Panel Alarms

Sound Level vs Distance:

Various Measurement Distances	ZA Series Sound Level Category		
	Loud 85 – 95 dB @ 2 ft	Medium 75 – 85 dB @ 2 ft	Soft 65 – 85 dB @ 2 ft
10 cm (4 in)	100 to 110 dB	90 to 100 dB	80 to 90 dB
30 cm (1 ft)	91 to 101 dB	81 to 91 dB	71 to 81 dB
1 Meter	82 to 92 dB	72 to 82 dB	62 to 72 dB
10 ft	71 to 81 dB	61 to 71 dB	51 to 61 dB

The ZA Series of 22mm alarms measures sound level at 2 feet. Since sound level drops over distance, the above chart lists the equivalent sound levels at various distances.

For example, if the Mallory part is in the **LOUD** sound level category, it has a sound level of 85 to 95 dB at 2 feet. At 10 cm, the sound level would measure 100 to 110 dB.

Packaging:

- Standard orders are bulk packed.
- For individual box packaging, add one of the following part numbers to order:

Part Number	Description
BOX	Individual box- no label
BOXLABEL	Individual box with label

Accessories:

Part Number	Description	Notes
ACC06	Replacement NEMA Gasket	Gasket comes with part
BOX	Individual box- no label	Must be ordered with part
BOXLABEL	Individual box with label	Must be ordered with part
KNT1-01	Replacement Nut	Nut comes with part