

*RoHS COMPLIANT



BOURNS®

Features

- Thick film technology
- Power rating of 0.25, 0.5 or 1 watt at 70 °C
- Low resistance values available
- RoHS compliant*

Applications

- Current sensing
- Power supplies
- Stepper motor drives
- Snubber resistor for flyback power supplies

CRM0805/1206/2010 High Power Current Sense Chip Resistors

Electrical Characteristics

Characteristic	Model CRM0805	Model CRM1206	Model CRM2010
Power Rating @ 70 °C	0.25 W	0.5 W	1 W
Operating Temperature Range	-55 °C to +155 °C		
Derated to Zero Load at	+155 °C		
Maximum Working Voltage 47 mohms to 910 mohms 1 ohm to 1 megohm	551 mV 150 V	675 mV 200 V	954 mV 200 V
Insulation Resistance	>1000 megohms		
Resistance Range	47 mohms to 910 mohms (±1 % and ±5 %, E24 Series) 1 ohm to 1 megohm (±1 %, E96 & E24 Series) 0 ohm, 1 ohm to 1 megohm (±5 %, E24 Series)		
Resistance Tolerance	±1 %, ±5 %		
Temperature Coefficient 47 mohms to 91 mohms (±1 % and ±5 %, E24 Series)	±100 ppm	±100 ppm	±100 ppm
100 mohms to 910 mohms (±1 % and ±5 %, E24 Series)	±100 ppm	±100 ppm	±100 ppm
1 ohm to 1 megohm (±1 %, E96 & E24 Series)	±100 ppm (1)	±100 ppm	±100 ppm
1 ohm to 1 megohm (±5 %, E24 Series)	±200 ppm	±200 ppm	±200 ppm
Zero Ohm Jumper <0.02 ohm (2) Maximum Rated Current	4 A	4 A	6 A

Exceptions:

(1) ±1 %, 1 ohm to 9.76 ohms: ±150 ppm (CRM0805)

(2) Jumper (0 ohms): Temperature coefficient is not applicable.

General Information

Bourns® CRM Series are thick film chip resistors with high power ratings making them suitable for different applications in power supply circuits including current sensing and current limiting.

Characteristic Data

Test	ΔR Max.
Load Life (1000 hours) Rated Voltage @ 70 °C (1.5 hrs. on, 0.5 hrs. off) 1 % Tolerance 5 % Tolerance	< 1 % < 3 %
Short Term Overload (5 X Rated Power for 5 sec.) 1 % Tolerance 5 % Tolerance	< 1 % < 2 %
Thermal Shock (5 Cycles: -55 °C/30 min.; +25 °C/2-3 min.; +155 °C/ 30 min.; +25 °C/2-3 min.) 1 % Tolerance 5 % Tolerance	< 0.5 % < 1 %

For Standard Values Used in Capacitors, Inductors and Resistors, [click here](#).

Product Dimensions

Model	L	W	C	D	T
CRM0805	$\frac{2.00 \pm 0.15}{(0.079 \pm 0.006)}$	$\frac{1.20 \pm 0.15}{(0.047 \pm 0.006)}$	$\frac{0.40 \pm 0.20}{(0.016 \pm 0.008)}$	$\frac{0.40 \pm 0.20}{(0.016 \pm 0.008)}$	$\frac{0.50 \pm 0.10}{(0.020 \pm 0.04)}$
CRM1206	$\frac{3.10 \pm 0.15}{(0.122 \pm 0.006)}$	$\frac{1.60 \pm 0.15}{(0.063 \pm 0.006)}$	$\frac{0.50 \pm 0.25}{(0.020 \pm 0.010)}$	$\frac{0.50 \pm 0.25}{(0.020 \pm 0.010)}$	$\frac{0.55 \pm 0.10}{(0.022 \pm 0.004)}$
CRM2010	$\frac{5.00 \pm 0.20}{(0.197 \pm 0.008)}$	$\frac{2.50 \pm 0.20}{(0.098 \pm 0.008)}$	$\frac{0.60 \pm 0.25}{(0.024 \pm 0.010)}$	$\frac{0.60 \pm 0.25}{(0.024 \pm 0.010)}$	$\frac{0.60 \pm 0.10}{(0.024 \pm 0.004)}$

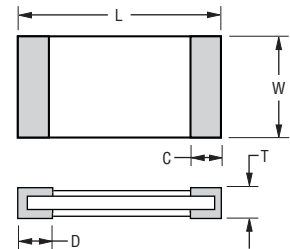

Recommended Solder Pad Layout

Model	A	B	L
CRM0805	$\frac{1.3}{(0.051)}$	$\frac{1.15}{(0.045)}$	$\frac{1.2}{(0.047)}$
CRM1206	$\frac{1.8}{(0.071)}$	$\frac{1.3}{(0.051)}$	$\frac{2.1}{(0.083)}$
CRM2010	$\frac{3.0}{(0.118)}$	$\frac{1.5}{(0.059)}$	$\frac{3.8}{(0.149)}$

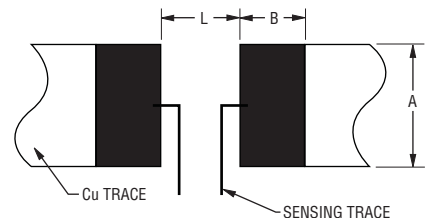

DIMENSIONS: $\frac{\text{MM}}{\text{(INCHES)}}$

*RoHS Directive 2002/95/EC Jan. 27, 2003 including annex and RoHS Recast 2011/65/EU June 8, 2011. Specifications are subject to change without notice.

The device characteristics and parameters in this data sheet can and do vary in different applications and actual device performance may vary over time. Users should verify actual device performance in their specific applications.

Soldering Profile

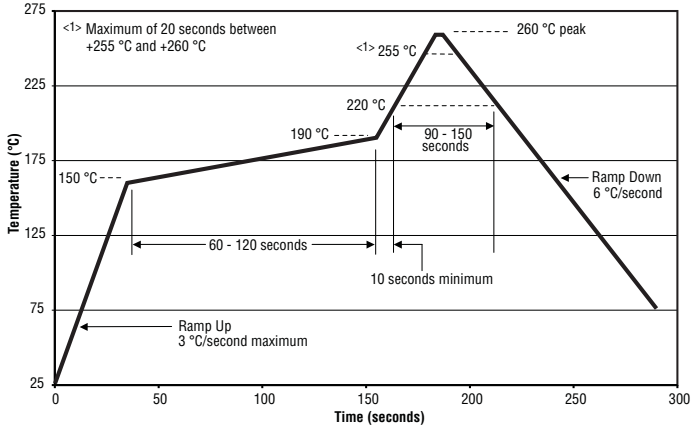

Derating Curve

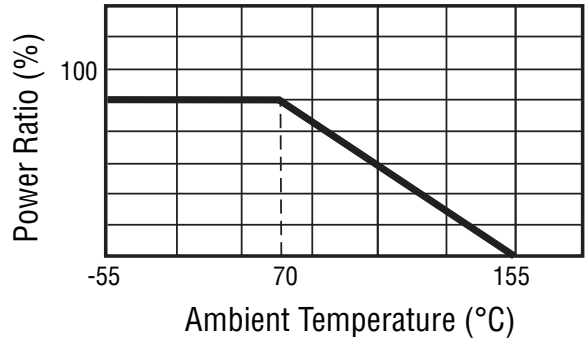

Pulse Load Characteristics

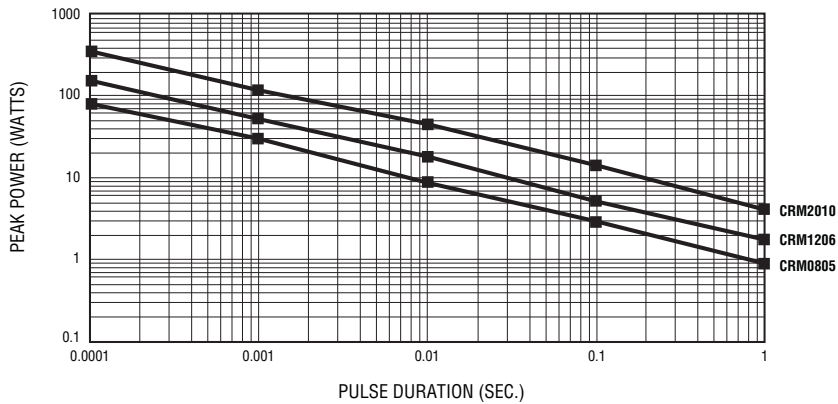

CRM0805/1206/2010 High Power Current Sense Chip Resistors



Packaging Dimensions (Conforms to EIA RS-481A)

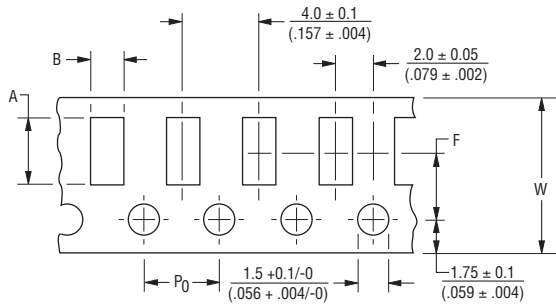

Maximum 1 mm (.040) thick
 * Cumulative over 10 holes: ±0.2 mm

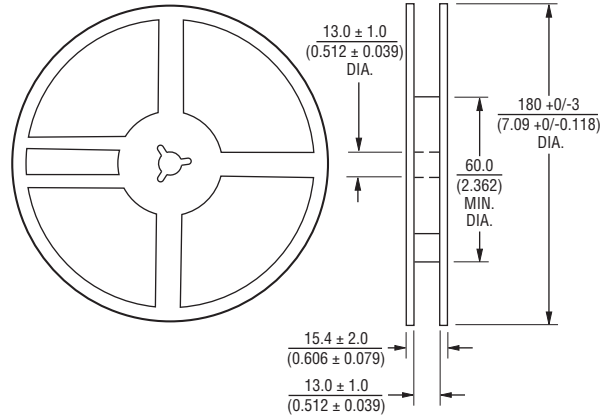

Model	A	B	F	W
CRM0805	2.40 ± 0.20 (0.094 ± 0.008)	1.65 ± 0.20 (0.065 ± 0.008)	3.50 ± 0.05 (0.138 ± 0.002)	8.00 ± 0.30 (0.315 ± 0.012)
CRM1206	3.57 ± 0.20 (0.141 ± 0.008)	2.00 ± 0.20 (0.079 ± 0.008)	3.50 ± 0.05 (0.138 ± 0.002)	8.00 ± 0.30 (0.315 ± 0.012)
CRM2010	5.50 ± 0.20 (0.217 ± 0.008)	2.80 ± 0.20 (0.110 ± 0.008)	5.50 ± 0.05 (0.217 ± 0.002)	12.00 ± 0.30 (0.472 ± 0.012)

DIMENSIONS: $\frac{\text{MM}}{\text{(INCHES)}}$

How to Order

CRM 2010 - F X - R100 E LF

Model _____ (CRM = Precision Chip Resistor)					
Size _____ 0805 = 0805 Size 1206 = 1206 Size 2010 = 2010 Size					
Resistance Tolerance _____ • F = ±1 %.....Use with "X" TCR code <u>Exceptions:</u> (CR0805) Use with "Z" TCR code for values from 1 ohm to 9.76 ohms • J = ±5 %.....Use with "W" TCR code for values from 1 ohm through 1 megohm Use with "X" TCR code for values under 1 ohm <u>Exceptions:</u> Use with "/" TCR code for 0 ohm (Jumper)					
TCR (PPM/°C - See Electrical Characteristics chart) _____ • W = ±200 PPM/°C • Z = ±150 PPM/°C • X = ±100 PPM/°C • / = Jumper					
Resistance Value _____ • <u>1 % or 5 % Tolerance:</u> R <1 ohm....."R" represents decimal point followed by three significant digits (example: R100 = 0.100 ohm) • <u>1% Tolerance:</u> <100 ohms "R" represents decimal point (example: 24R3 = 24.3 ohms) ≥100 ohmsFirst three digits are significant, fourth digit represents number of zeros to follow (example: 8252 = 82.5K ohms) • <u>5% Tolerance:</u> <10 ohms "R" represents decimal point (example: 4R7 = 4.7 ohms) ≥10 ohmsFirst two digits are significant, third digit represents number of zeros to follow (example: 474 = 470K ohms) 0 ohm Jumper "000"					
Packaging _____ • E = 5,000 pieces on 180 mm (7 inch) reel - CRM0805, CRM1206 4,000 pieces on 180 mm (7 inch) reel - CRM2010					
Termination _____ • LF = Tin-plated (RoHS Compliant)					