

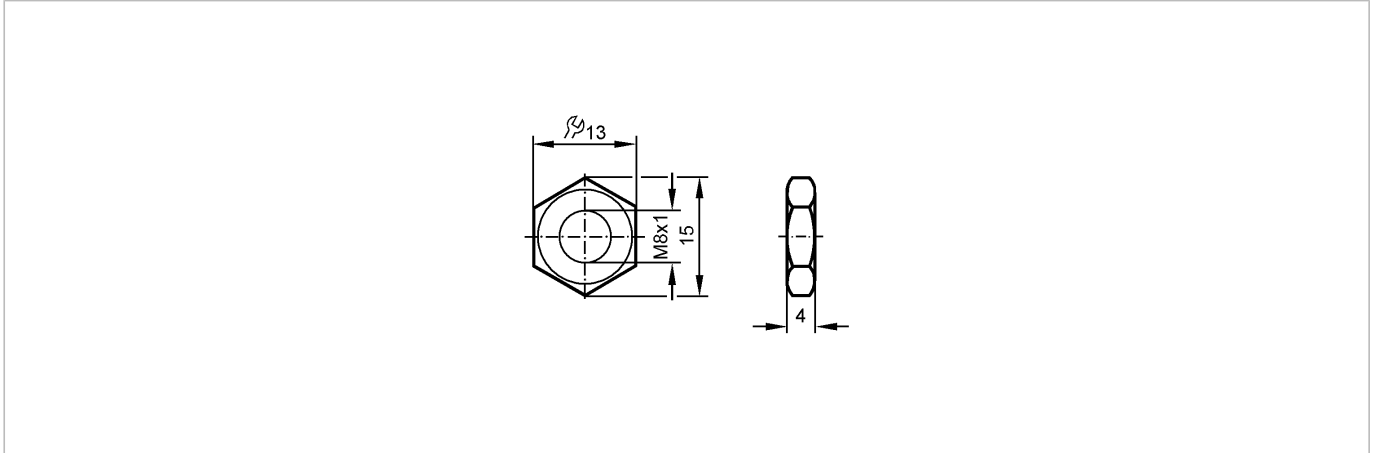

NUT M8X1 BRASS 2 PIECES

Accessories



Product characteristics

Lock nuts metal

M8 x 1

Mechanical data

Housing materials

Brass nickel-plated

Weight

[kg]

0.008

Remarks

Pack quantity

[piece]

2