

M12 MALE 0° / M12 FEMALE 90°

PVC 3X0.34 black UL/CSA 5m

Male straight to female 90°

M12 - M12, 3-pole (bridged)

Art.-No. 7005 - M12 Lite - (plastic hexagonal screw) on request

Plastic housings with good resistance against chemicals and oils. The resistance to aggressive media should be individually tested for your application. Further details on request. Further cable lengths on request.

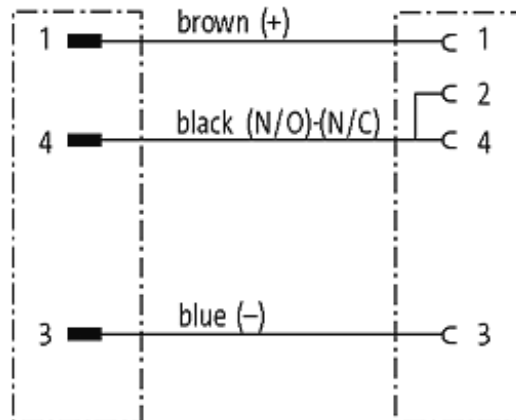
[Link to Product](#)**Illustration**

Male

Female

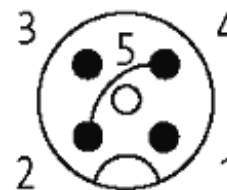
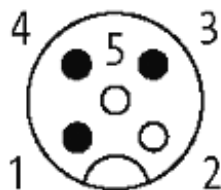

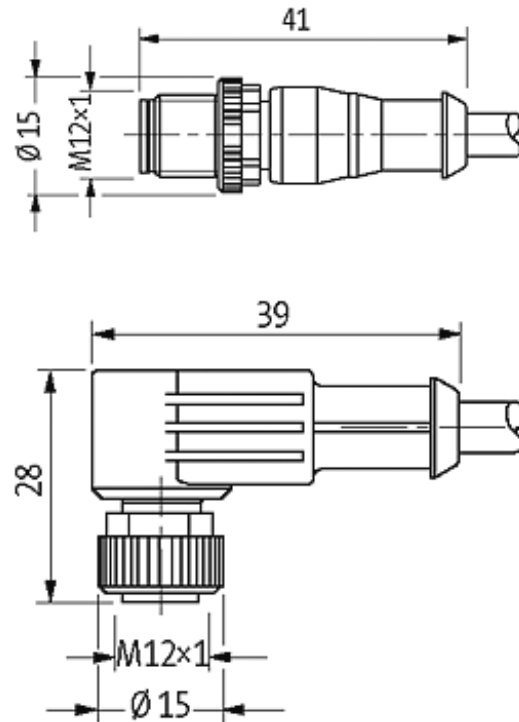

Product may differ from Image

Approvals



Form

40161

Technical Data

Protection	IP67 inserted and tightened (EN 60529)
Operating voltage	max. 250 V AC/DC
Operating current per contact	max. 4 A
Locking of ports	Screw thread M12 × 1 mm (recommended torque 0.6 Nm) self-securing

Cables

Cable number	613
No./diameter of wires	3 × 0.34 mm ²
Wire isolation	PVC (br, bl, bk)
Jacket Color	black
Shore hardness outer jacket	85 ± 5A
Material (jacket)	PVC (UL/CSA)
Outer diameter	approx. 4.6 mm
Bend radius (fixed)	5 × outer Ø
Bend radius (moving)	10 × outer Ø

Temperature range (fixed)	-30...+80 °C
Temperature range (mobile)	-5...+80 °C

Commercial data

country of origin	DE
customs tariff number	85444290
minimum order quantity	1