

M12 male 0° / M12 female 90° shielded

PUR 5x0.34 shielded bk UL/CSA+drag chain 6m

Male straight to female 90°
M12 - M12, 5-pole

Plastic housings with good resistance against chemicals and oils. The resistance to aggressive media should be individually tested for your application. Further details on request. Further cable lengths on request.

[Link to Product](#)

Illustration

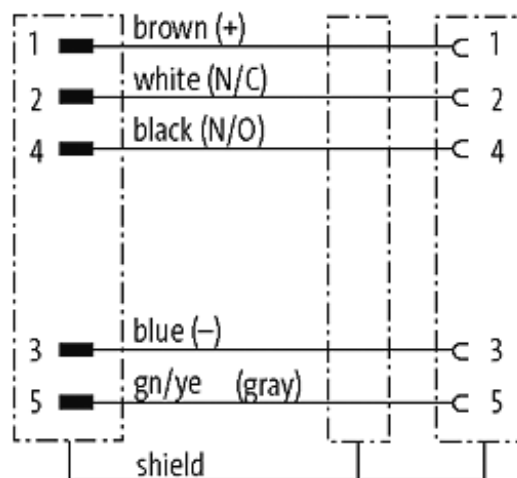

Male

Female

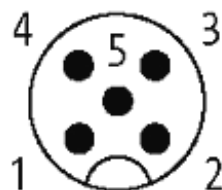



Product may differ from Image