

**Temperature measurement
Probe
TP-206A-CF-H1141-L450**

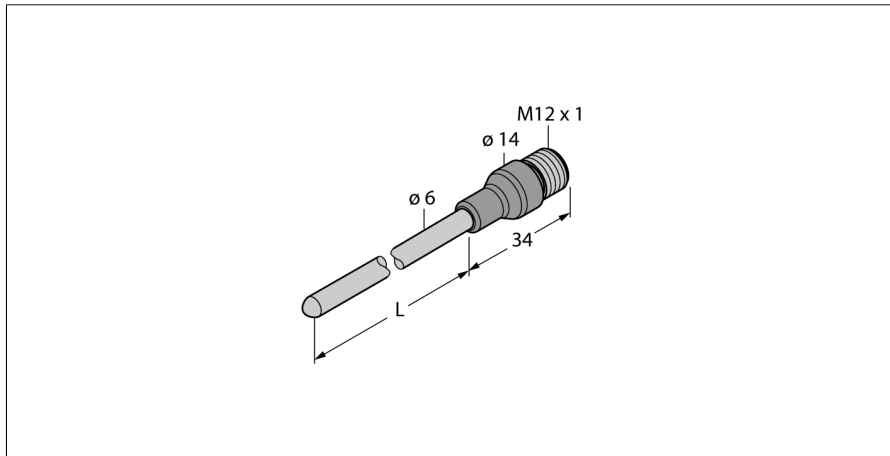

- Pt-100 probe acc. to DIN EN 60751
- Vibration and shock-resistant
- Connectable to TS, TTM, IM34, BL20, BL67
- 4-wire connection technology

Wiring Diagram

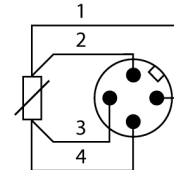

General description

Resistance thermometers are used for the detection and monitoring of temperatures to optimize and control a process.

Typical applications are in machine and plant construction as well as in the process industry.

The core element of the temperature sensor is a temperature-dependent resistor.

Type designation	TP-206A-CF-H1141-L450
Ident no.	9910610
Temperature range	-50...500 °C
Temperature operating range	-58...932°F
Measuring element	Pt-100 probe, DIN EN 60751, class A
Accuracy	0.15 °C + 0.002 · t (-30 ...350 °C)
Response time	t 0.5 = 6 s / t 0.9 = 15 s in water at 0.2 m/s
Immersion depth (L)	450 mm
Protection type and class	IP67
Ambient conditions	
Ambient temperature	-40...+120 °C
Storage temperature	-40...+85 °C
Housing	
Sensor material	stainless steel, AISI 316L
Process connection	For cutting ring fittings, thermowell or direct mounting
Electrical connection	Connector, M12, 4-pin
Pressure resistance	100 bar
Reference conditions acc. to IEC 61298-1	
Temperature	15...+25 °C
Atmospheric pressure	860...1060 hPa abs.
Humidity	45...75 % rel.
Auxiliary power	24 VDC
MTTF	2283 acc. to SN 29500 (Ed. 99) 20 °C

**Temperature measurement
Probe
TP-206A-CF-H1141-L450**

Accessories

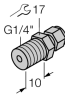
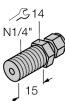
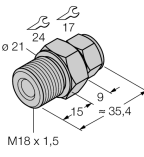
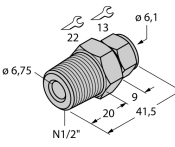
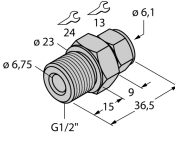
Type code	Ident no.	Description	
CF-M-6-G1/4-A4	9910483	Compression ferrule fittings for direct mounting of temperature probes	
CF-M-6-N1/4-A4	9910484	Compression ferrule fittings for direct mounting of temperature probes	
CF-M-6-M18-A4	9910525	Compression ferrule fittings for direct mounting of temperature probes	
CF-M-6-N1/2-A4	9910529	Compression ferrule fittings for direct mounting of temperature probes	
CF-M-6-G1/2-A4	9910530	Compression ferrule fittings for direct mounting of temperature probes	

**Temperature measurement
Probe
TP-206A-CF-H1141-L450**

Wiring accessories

Type code	Ident no.	Description	
WKC4.4T-2/TEL	6625025	Connection cable, female M12, angled, 4-pin, cable length: 2 m, sheath material: PVC, black; cULus approval; other cable lengths and qualities available, see www.turck.com	
RKC4.4T-2/TXL	6625503	Connection cable, female M12, straight, 4-pin, cable length: 2 m, sheath material: PUR, black; cULus approval; other cable lengths and qualities available, see www.turck.com	
WKC4.4T-2/TXL	6625515	Connection cable, female M12, angled, 4-pin, cable length: 2 m, sheath material: PUR, black; cULus approval; other cable lengths and qualities available, see www.turck.com	
RKC4.4T-P7X2-10/TXL	6626184	Connection cable, female M12, angled, 4-pin, cable length: 10m, sheath material: PUR, black; cULus approval; other cable lengths and qualities available, see www.turck.com	