

M12 MALE 0° / M12 FEMALE 90° SHIELDED

PUR 5X0.34 shielded GRAY, 1m

Male straight to female 90°
M12 - M12, 5-pole

Plastic housings with good resistance against chemicals and oils. The resistance to aggressive media should be individually tested for your application. Further details on request. Further cable lengths on request.

[Link to Product](#)

Illustration

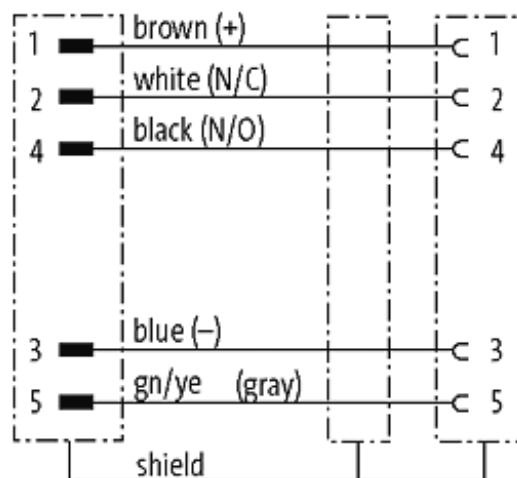
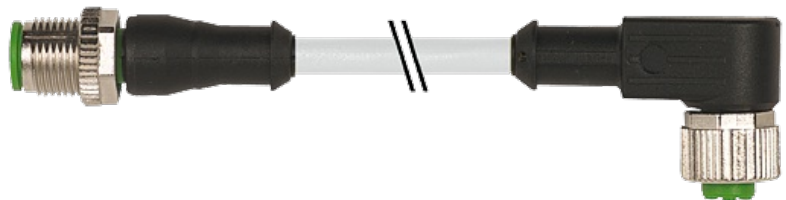

Male

Female

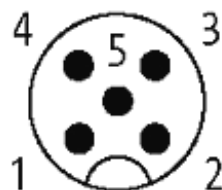

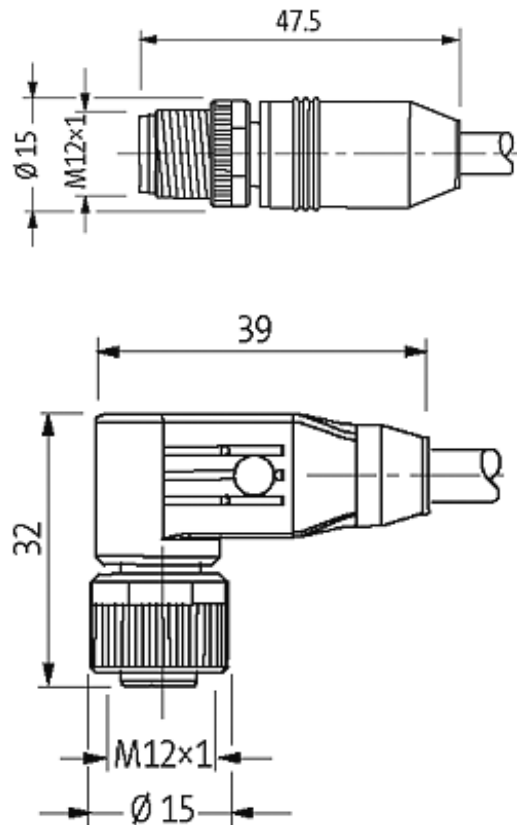

Product may differ from Image

Approvals



Form

40541

Technical Data

Protection	IP67 inserted and tightened (EN 60529)
Operating voltage	max. 125 V AC/DC
Operating current per contact	max. 4 A
Locking of ports	Screw thread M12 × 1 mm (recommended torque 0.6 Nm) self-securing

Cables

Cable number	349
No./diameter of wires	5 × 0.34 mm ²
Wire isolation	PVC (br, wh, bl, bk, gnye)
C-track properties	0.1 Mio.
Jacket Color	gray
Shore hardness outer jacket	85 ± 5A
Material (jacket)	PUR/PVC

The information in this brochure has been compiled with the utmost care.

Liability for the correctness completeness and topicality of the information is restricted to gross negligence. Version: 05/15

Outer diameter	approx. 5.9 mm
Bend radius (fixed)	10 × outer Ø
Bend radius (moving)	15 × outer Ø
Temperature range (fixed)	-40...+80 °C
Temperature range (mobile)	-5...+70 °C
Shielded	yes

General data

Temperature range	-25...+85 °C, depending on cable quality
-------------------	--

Commercial data

country of origin	DE
customs tariff number	85444290
minimum order quantity	1