



ATTENTION
OBSERVE PRECAUTIONS
FOR HANDLING
ELECTROSTATIC
DISCHARGE
SENSITIVE
DEVICES

Part Number: L-154A4SURKQBDZGW

Hyper Red
Blue
Green

Features

- Uniform light output.
- Low power consumption.
- Long life-solid state reliability.
- RoHS compliant.

Description

The Hyper Red source color devices are made with Al-GaN on GaAs substrate Light Emitting Diode.

The Blue source color devices are made with InGaN Light Emitting Diode.

The Green source color devices are made with InGaN on Sapphire Light Emitting Diode.

Static electricity and surge damage the LEDs.

It is recommended to use a wrist band or anti-electrostatic glove when handling the LEDs.

All devices, equipment and machinery must be electrically grounded.

Package Dimensions

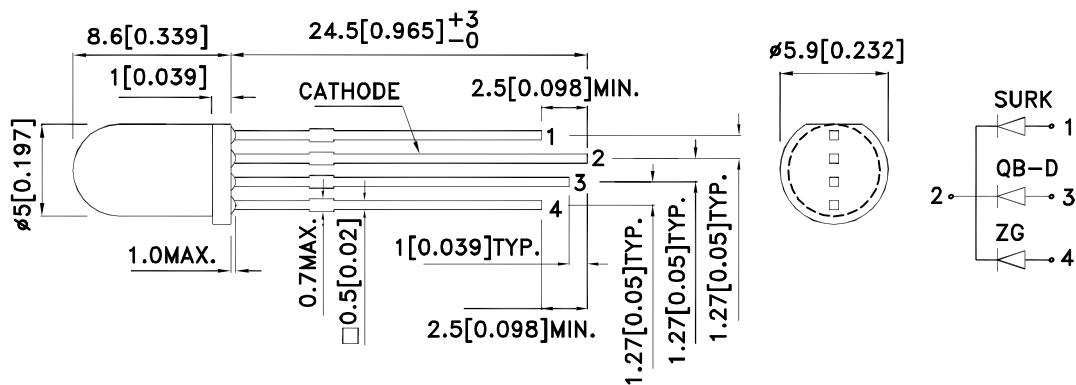

Notes:

1. All dimensions are in millimeters (inches).
2. Tolerance is $\pm 0.25 (0.01)$ unless otherwise noted.
3. Lead spacing is measured where the leads emerge from the package.
4. The specifications, characteristics and technical data described in the datasheet are subject to change without prior notice.



Selection Guide

Part No.	Dice	Lens Type	Iv (mcd) [2] @ 20mA		Viewing Angle [1]
			Min.	Typ.	2θ1/2
L-154A4SURKQBDZGW	Hyper Red (AlGaInP)	White Diffused	500	1000	60°
	Blue (InGaN)		150	300	
	Green (InGaN)		600	1300	

Notes:

1. θ1/2 is the angle from optical centerline where the luminous intensity is 1/2 of the optical peak value.
2. Luminous intensity/ luminous Flux: +/-15%.

Electrical / Optical Characteristics at TA=25°C

Symbol	Parameter	Device	Typ.	Max.	Units	Test Conditions
λpeak	Peak Wavelength	Hyper Red Blue Green	650 468 515		nm	If=20mA
λD [1]	Dominant Wavelength	Hyper Red Blue Green	630 470 525		nm	If=20mA
Δλ1/2	Spectral Line Half-width	Hyper Red Blue Green	28 25 30		nm	If=20mA
C	Capacitance	Hyper Red Blue Green	35 100 45		pF	Vf=0V;f=1MHz
Vf [2]	Forward Voltage	Hyper Red Blue Green	1.95 3.3 3.3	2.5 4 4.1	V	If=20mA
IR	Reverse Current	Hyper Red Blue Green		10 50 50	uA	Vr=5V

Notes:

1. Wavelength: +/-1nm.
2. Forward Voltage: +/-0.1V.

Absolute Maximum Ratings at TA=25°C

Parameter	Hyper Red	Blue	Green	Units
Power dissipation	75	120	102.5	mW
DC Forward Current	30	30	25	mA
Peak Forward Current [1]	185	150	150	mA
Reverse Voltage	5			V
Operating/Storage Temperature	-40°C To +85°C			
Lead Solder Temperature [2]	260°C For 3 Seconds			
Lead Solder Temperature [3]	260°C For 5 Seconds			

Notes:

1. 1/10 Duty Cycle, 0.1ms Pulse Width.
2. 2mm below package base.
3. 5mm below package base.

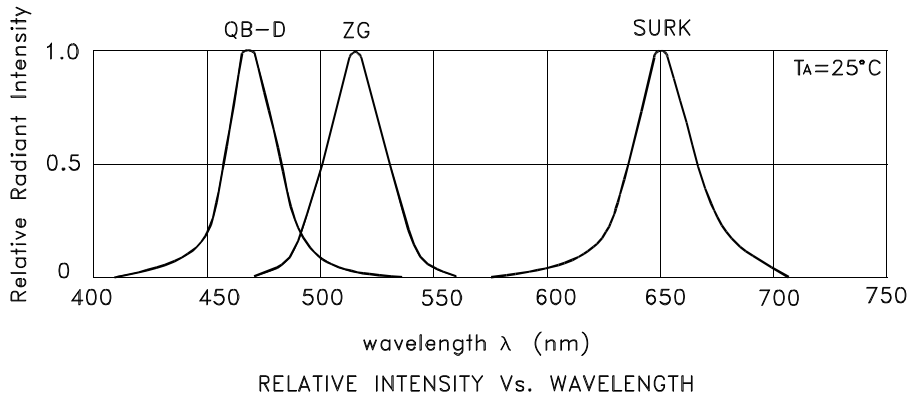

L-154A4SURKQBDZGW Hyper Red

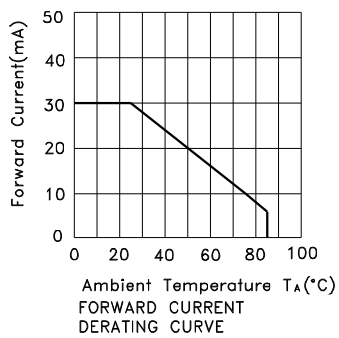
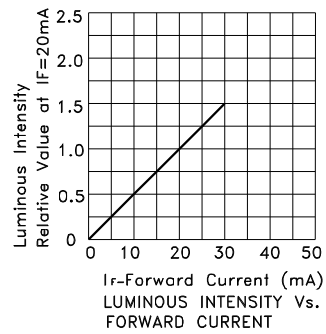
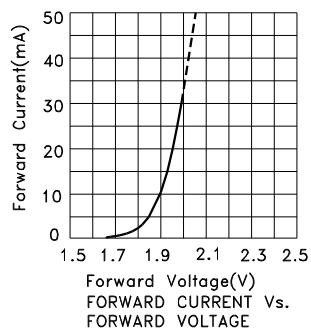

Kingbright

Blue

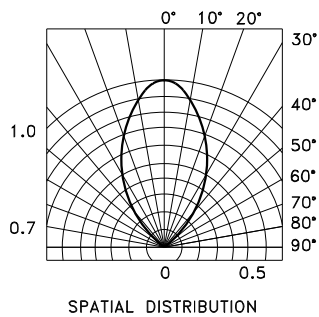
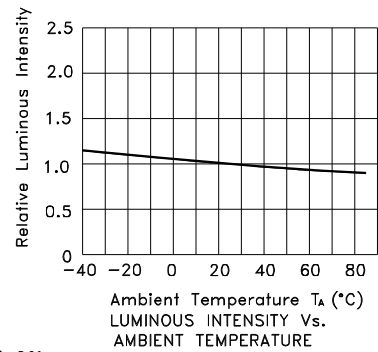
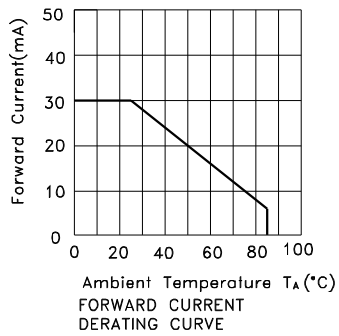
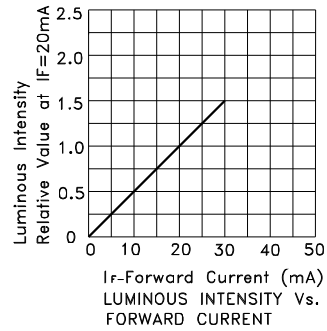
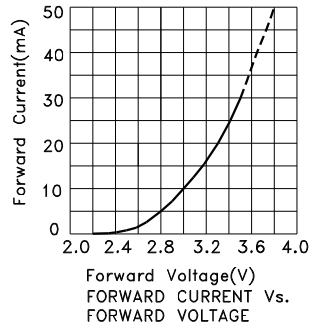

Green

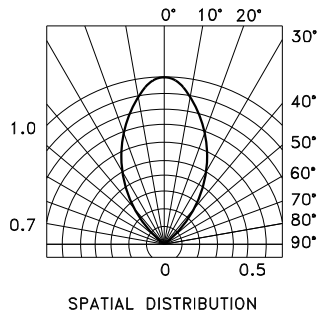
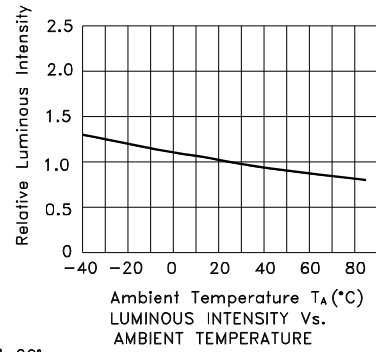
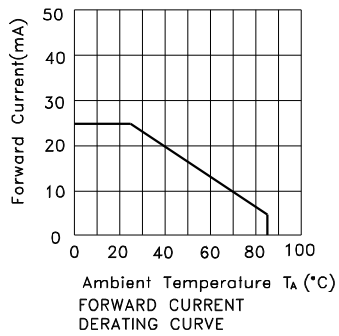
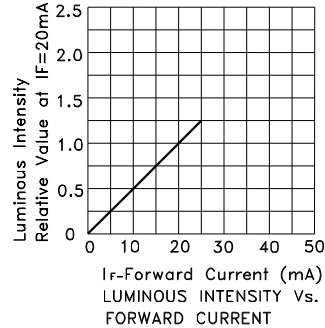
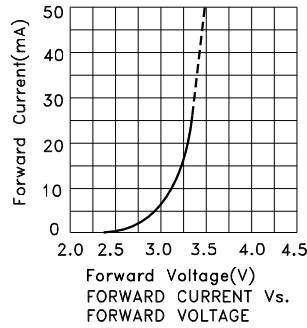

L-154A4SURKQBDZGW

Wave Soldering Profile For Lead-free Through-hole LED.

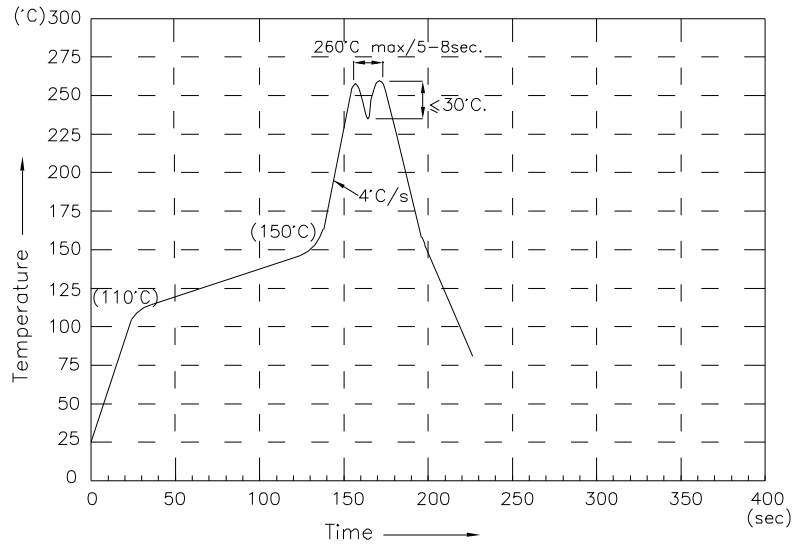

NOTES:

- 1.Recommend the wave temperature 245°C~260°C.The maximum soldering temperature should be less than 260°C.
- 2.Do not apply stress on epoxy resins when temperature is over 85 degree°C.
- 3.The soldering profile apply to the lead free soldering (Sn/Cu/Ag alloy).
- 4.No more than once.

PACKING & LABEL SPECIFICATIONS

L-154A4SURKQBDZGW

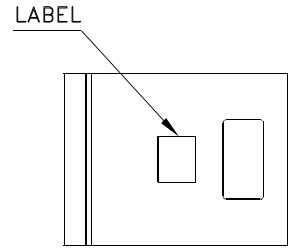
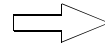
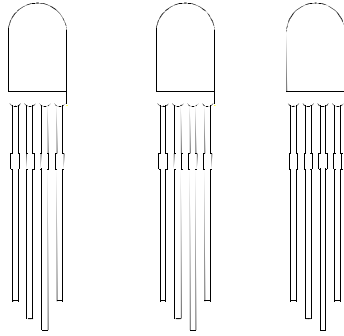

500PCS / BAG



20K / 9# BOX

OUTSIDE LABEL

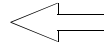

OUTSIDE LABEL

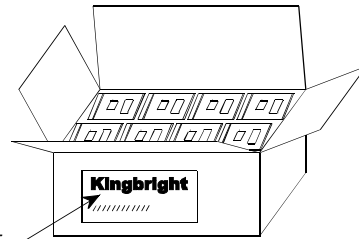

10K / 5# BOX

<h1>Kingbright</h1>	
P/NO: L-154A4xxx	
QTY: 500 pcs	Q.C. Q C XX XX XXXX PASSED
S/N: XXXX	
CODE: XXX	
LOT NO:	
 xxxxxxxxxxxxxxxxxxxxxxxx	
RoHS Compliant	

LED MOUNTING METHOD

1. The lead pitch of the LED must match the pitch of the mounting holes on the PCB during component placement. Lead-forming may be required to insure the lead pitch matches the hole pitch. Refer to the figure below for proper lead forming procedures.

(Fig. 1)

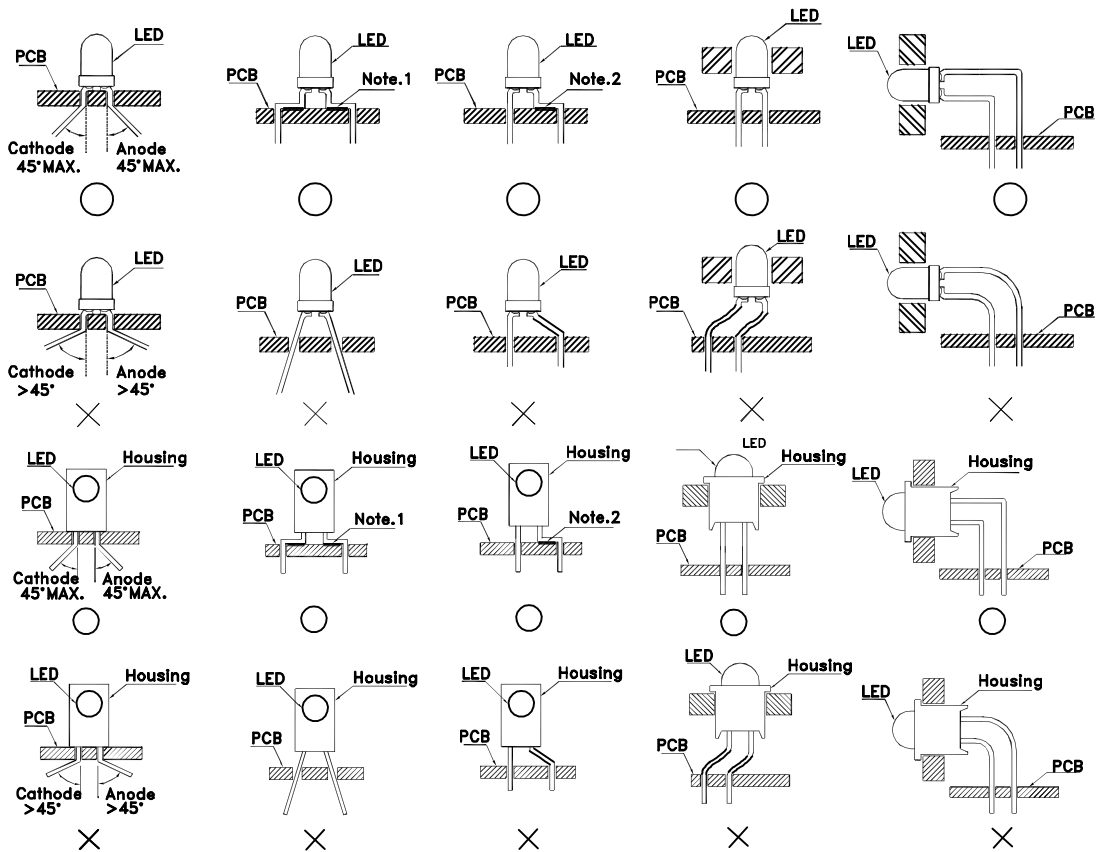

Fig.1

“O” Correct mounting method “X” Incorrect mounting method
 Note 1-2 : Do not route PCB trace in the contact area between the leadframe and the PCB to prevent short-circuits.

2. When soldering wire to the LED, use individual heat-shrink tubing to insulate the exposed leads to prevent accidental contact short-circuit.
 (Fig. 2)

3. Use stand-offs (Fig. 3) or spacers (Fig. 4) to securely position the LED above the PCB.

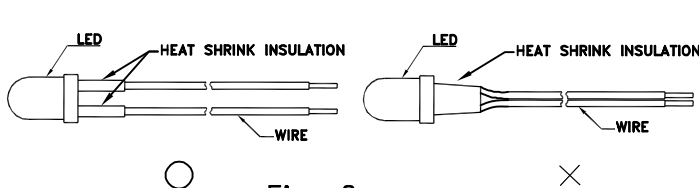

Fig. 2

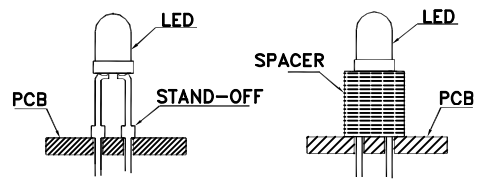
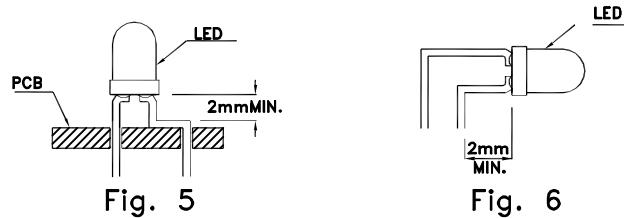

Fig. 3

Fig. 4

LEAD FORMING PROCEDURES

1. Maintain a minimum of 2mm clearance between the base of the LED lens and the first lead bend. (Fig. 5 and 6)



2. Lead forming or bending must be performed before soldering, never during or after Soldering.
3. Do not stress the LED lens during lead-forming in order to fractures in the lens epoxy and damage the internal structures.
4. During lead forming, use tools or jigs to hold the leads securely so that the bending force will not be transmitted to the LED lens and its internal structures. Do not perform lead forming once the component has been mounted onto the PCB. (Fig. 7)
5. Do not bend the leads more than twice. (Fig. 8)
6. After soldering or other high-temperature assembly, allow the LED to cool down to 50°C before applying outside force (Fig. 9). In general, avoid placing excess force on the LED to avoid damage. For any questions please consult with Kingbright representative for proper handling procedures.

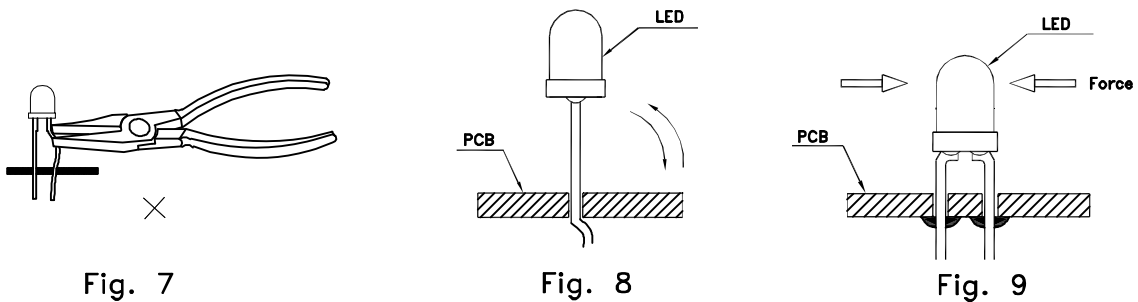

7. No stress shall be applied on the LED during soldering to prevent damage.

