

03

0331

Circular connectors with threaded joint M16 acc. to IEC 61076-2-106, IP40/IP67/IP68



Plug acc. to IEC 61076-2-106, IP68, with threaded joint and solder terminals

03

0331

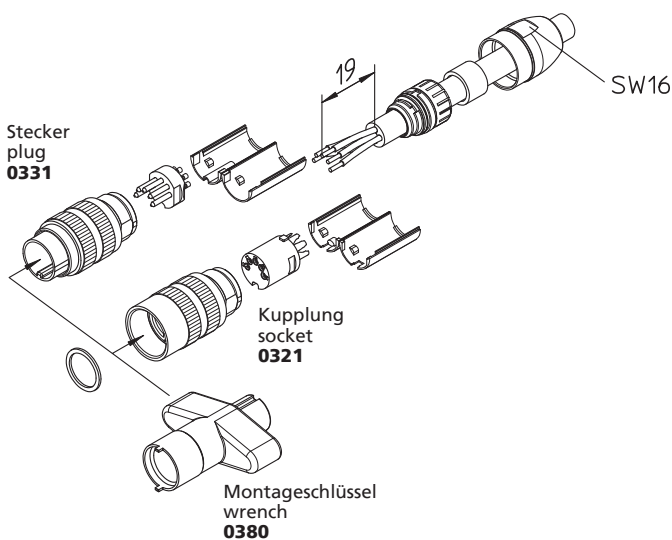
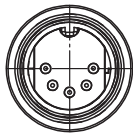
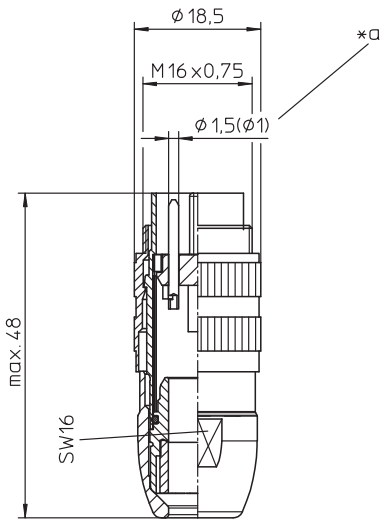

Environmental conditions

Temperature range -40 °C/+85 °C

Materials

Insulating body	PA GF, V-0 according to UL94
Contact pin	CuZn, silver-plated and flash gold-plated (3-8 poles) CuZn, pre-nickel and gold-plated (12-14 poles)
Housing	CuZn, nickel-plated
Knurled screw	CuZn, nickel-plated
Seal	NBR

Mechanical data

Tightening torque connector	1-3 Nm
Tightening torque nut	1-3 Nm
Protection class	IP68 ¹

¹ according to IEC DIN EN 60529, only in locked condition with an appropriate counterpart; IPX8 requirements under agreement between manufacturer and user

Connectable conductors for solder area

Section	≤ 0.75 mm ² (AWG 20) (3-8 poles) ≤ 0.25 mm ² (AWG 24) (12-14 poles)
Cable diameter	4-8 mm

Electrical data (at T_{amb} 20 °C)

Rated current	5 A (T _{amb} 40 °C, 3-8 poles) 3 A (T _{amb} 40 °C, 12-14 poles)
Rated voltage	250 V (versions 03, 04, 05-1, 06, 07) 60 V (versions 05, 07-1, 08, 08-1, 12, 14)
Rated impulse voltage	2000 V (versions 03, 04, 05-1, 06, 07) 1000 V (versions 05, 07-1, 08, 08-1, 12, 14)
Insulation resistance	> 100 MΩ

Associated products

Counterparts		
☞ 0304	☞ 0304-1	☞ 0304-2
☞ 0305	☞ 0305-1	☞ 0305-1 U
☞ 0305-2	☞ 0306	☞ 0306-1
☞ 0306-2	☞ 0307	☞ 0307-1

03

0331

Pin configurations, solder side view

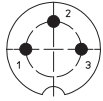

03-a
0331 03

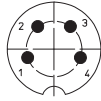

04-a
0331 04

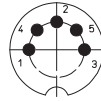

05-b
0331 05

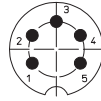

05-a
0331 05-1

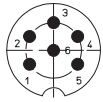

06-a
0331 06

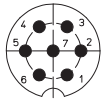

07-a
0331 07

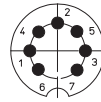

07-b
0331 07-1

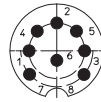

0331 08

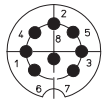

08-a
0331 08-1

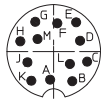

12-a
0331 12

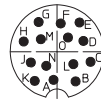

14-a
0331 14

☞ 0307-2	☞ 030798-1	☞ 030798-2
☞ 030799-2	☞ 0308	☞ 0308-1
☞ 0308-2	☞ 0321	☞ 0322
☞ 0322-1	☞ 032200	☞ 0360
☞ 036000	☞ 0362	☞ 036297
☞ 0363		
Accessories		
☞ 0383	☞ 038399	☞ 038899

*a 12 and 14 pole version Ø 1.0 mm

03

0331

Designation	Pole Number	PU (Pieces)	MDQ (Pieces)
0331 03	3	50	100
0331 04	4	50	100
0331 05	5	50	100
0331 05-1	5	50	100
0331 06	6	50	100
0331 07	7	50	100
0331 07-1	7	50	100
0331 08	8	50	100
0331 08-1	8	50	100
0331 12	12	50	100
0331 14	14	50	100

Packaging:

sets of individual parts in plastic bags, in a cardboard box