



**Part no.: 50109640**  
**IS 208MM/4NO-1E5-S8.3**  
**Inductive switch**



Figure can vary

## Contents

- Technical data
- Dimensioned drawings
- Electrical connection
- Diagrams
- Operation and display
- Part number code
- Notes
- Accessories

## Technical data

<b>Basic data</b>	
Series	208
Typ. operating range limit $S_n$	1.5 mm
Operating range $S_a$	0 ... 1.2 mm
<b>Characteristic parameters</b>	
MTTF	900 years
<b>Electrical data</b>	
Protective circuit	Inductive protection Polarity reversal protection Short circuit protected
<b>Performance data</b>	
Supply voltage $U_B$	10 ... 30 V , DC
Residual ripple	0 ... 20 % , From $U_B$
Open-circuit current	0 ... 10 mA
Temperature drift, max. (in % of $S_r$ )	10 % , Over the entire operating temperature range
Repeatability, max. (in % of $S_r$ )	5 % , For $U_B = 20 \dots 30$ V DC, ambient temperature $T_a = 23 \text{ °C} \pm 5 \text{ °C}$
Switching hysteresis	10 %
<b>Outputs</b>	
Number of digital switching outputs	1 Piece(s)
<b>Switching outputs</b>	
Voltage type	DC
Switching current, max.	200 mA
Residual current, max.	0.1 mA
Voltage drop	$\leq 2$ V
<b>Switching output 1</b>	
Switching element	Transistor , PNP
Switching principle	NO (normally open)
<b>Timing</b>	
Switching frequency	5,000 Hz
Readiness delay	32 ms
<b>Connection</b>	
Number of connections	1 Piece(s)
<b>Connection 1</b>	
Type of connection	Connector
Function	Signal OUT Voltage supply
Thread size	M8
Type	Male
Material	Stainless steel
No. of pins	3 -pin
Encoding	A-coded
<b>Mechanical data</b>	

**Part no.: 50109640 – IS 208MM/4NO-1E5-S8.3 – Inductive switch**

Design	Cylindrical
Thread size	M8 x 1 mm
Dimension (Ø x L)	8 mm x 45 mm
Type of installation	Embedded
Housing material	Stainless steel , V2A
Sensing face material	Plastic , Polyamide (PA 66)
Net weight	12 g
Housing color	Red, RAL 3000 Silver
Type of fastening	Mounting thread Via optional mounting device
Standard measuring plate	8 x 8 mm <sup>2</sup> , Fe360

**Operation and display**

Type of display	LED
Number of LEDs	1 Piece(s)

**Environmental data**

Ambient temperature, operation	-25 ... 70 °C
Ambient temperature, storage	-25 ... 70 °C

**Certifications**

Degree of protection	IP 67
Protection class	III
Certifications	c UL US
Test procedure for EMC in accordance with standard	IEC 61000-4-2 IEC 61000-4-3 IEC 61000-4-4
Standards applied	IEC 60947-5-2

**Correction factors**

Aluminum	0.25
Stainless steel	0.7
Copper	0.2
Brass	0.35
Fe360 steel	1

**Classification**

Customs tariff number	85365019
eCl@ss 8.0	27270101
eCl@ss 9.0	27270101
ETIM 5.0	EC002714
ETIM 6.0	EC002714

## Dimensioned drawings

All dimensions in millimeters

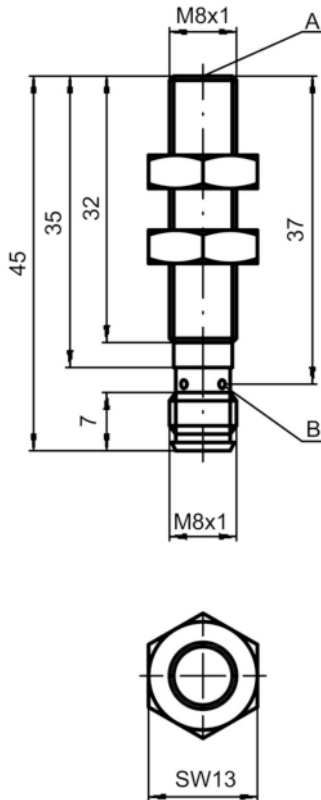

A Active surface  
B Yellow LED

## Electrical connection

Connection 1	
Type of connection	Connector
Function	Signal OUT Voltage supply
Thread size	M8
Type	Male
Material	Stainless steel
No. of pins	3 -pin
Encoding	A-coded

Pin	Pin assignment
1	V+
3	GND
4	OUT 1

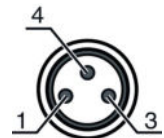

**Diagrams**

Embedded installation

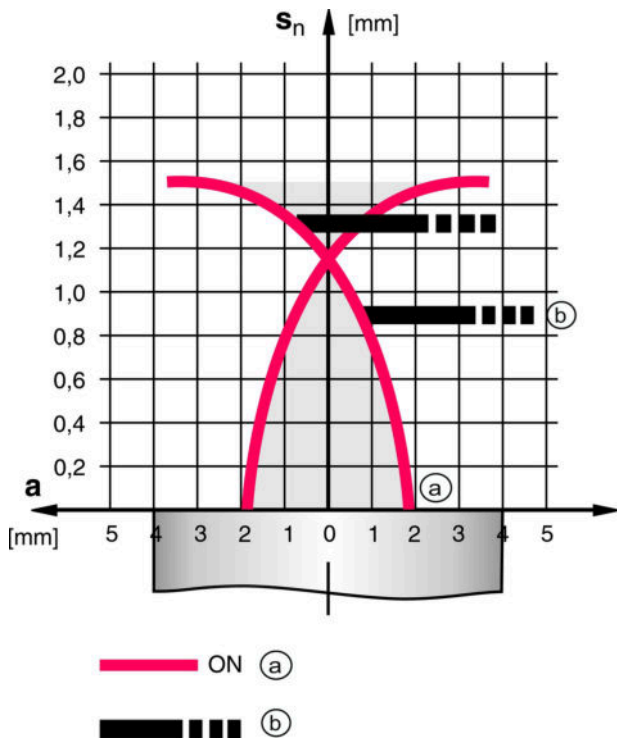

$S_n$ [mm]	1.5
$D1$ [mm]	0
$D2$ [mm]	2
$D3$ [mm]	1.5

Types with  $S_n = 1.5$  mm

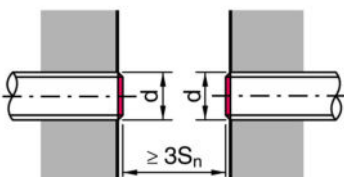
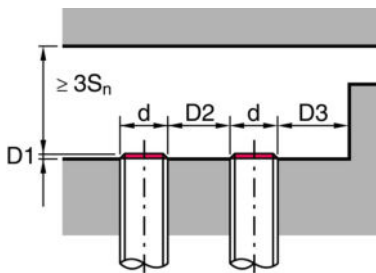

- a Inductive switch
- b Standard measuring plate

## Operation and display

### LEDs

LED	Display	Meaning
1	Yellow, continuous light	Switching output/switching state

## Part number code

Part designation: ISX YYY ZZ/AAA.BB-CCC-DDD-DDD

ISX	<b>Operating principle / construction:</b> IS: inductive switch, standard design ISS: inductive switch, short construction
YYY	<b>Series:</b> 203: series with Ø 3 mm 204: series with Ø 4 mm 205: series with M5 x 0.5 external thread 206: series with Ø 6.5 mm 208: series with M8 x 1 external thread 212: series with M12 x 1 external thread 218: series with M18 x 1 external thread 230: series with M30 x 1.5 external thread 240: series in cubic design 244: series in cubic design 255: series with 5 x 5 mm <sup>2</sup> cross section 288: series with 8 x 8 mm <sup>2</sup> cross section
ZZ	<b>Housing / thread:</b> MM: metal housing (active surface: plastic) / metric thread FM: full-metal housing (active surface: stainless steel AISI 316L) / metric thread MP: metal housing (active surface: plastic) / smooth (without thread)
AAA	<b>Output current / supply:</b> 4NO: PNP transistor, NO contact 4NC: PNP transistor, NC contact 2NO: NPN transistor, NO contact 2NC: NPN transistor, NC contact 1NO: relay, NO contact / AC/DC 1NC: relay, NC contact / AC/DC 44: 2 PNP transistor switching outputs, antivalent (NO + NC) 22: 2 NPN transistor switching outputs, antivalent (NO + NC)
BB	<b>Special equipment:</b> n/a: no special equipment 5F: food version 5: housing material V2A (1.4305, AISI 303)
CCC	<b>Measurement range / type of installation:</b> 1E0: typ. range limit 1.0 mm / embedded installation 1E5: typ. range limit 1.5 mm / embedded installation 2E0: typ. range limit 2.0 mm / embedded installation 3E0: typ. range limit 3.0 mm / embedded installation 4E0: typ. range limit 4.0 mm / embedded installation 5E0: typ. range limit 5.0 mm / embedded installation 6E0: typ. range limit 6.0 mm / embedded installation 8E0: typ. range limit 8.0 mm / embedded installation 10E: typ. range limit 10.0 mm / embedded installation 12E: typ. range limit 12.0 mm / embedded installation 15E: typ. range limit 15.0 mm / embedded installation 20E: typ. range limit 20.0 mm / embedded installation 22E: typ. range limit 22.0 mm / embedded installation 2N5: typ. range limit 2.5 mm / non-embedded installation 4N0: typ. range limit 4.0 mm / non-embedded installation 8N0: typ. range limit 8.0 mm / non-embedded installation 10N: typ. range limit 10.0 mm / non-embedded installation 12N: typ. range limit 12.0 mm / non-embedded installation 14N: typ. range limit 14.0 mm / non-embedded installation 15N: typ. range limit 15.0 mm / non-embedded installation 20N: typ. range limit 20.0 mm / non-embedded installation 22N: typ. range limit 22.0 mm / non-embedded installation 25N: typ. range limit 25.0 mm / non-embedded installation 40N: typ. range limit 40.0 mm / non-embedded installation
DDD	<b>Electrical connection:</b> n/a: cable, standard length 2000 mm S12: M12 connector, 4-pin, axial 200-S12: cable, length 200 mm with M12 connector, 4-pin, axial 200-S8.3: cable, length 200 mm with M8 connector, 3-pin, axial S8.3: M8 connector, 3-pin, axial 005-S8.3: cable, length 500 mm with M8 connector, 3-pin, axial 050: cable, standard length 5000 mm, 3-wire

Part no.: 50109640 – IS 208MM/4NO-1E5-S8.3 – Inductive switch

**Note**

A list with all available device types can be found on the Leuze electronic website at [www.leuze.com](http://www.leuze.com).

**Notes**

**Observe intended use!**



- This product is not a safety sensor and is not intended as personnel protection.
- The product may only be put into operation by competent persons.
- Only use the product in accordance with its intended use.

**For UL applications:**



- For UL applications, use is only permitted in Class 2 circuits in accordance with the NEC (National Electric Code).

**Accessories**

Connection technology - Connection cables

	Part no.	Designation	Article	Description
	50130842	KD U-M8-3A-P1-020	Connection cable	Connection 1: Connector, M8, Axial, Female, 3 -pin Connection 2: Open end Shielded: No Cable length: 2,000 mm Sheathing material: PUR
	50130844	KD U-M8-3A-P1-050	Connection cable	Connection 1: Connector, M8, Axial, Female, 3 -pin Connection 2: Open end Shielded: No Cable length: 5,000 mm Sheathing material: PUR

Mounting technology - Other

	Part no.	Designation	Article	Description
	50132727	AC D08M-CS	Clamp	Contains: 2x M12 mounting nut Diameter, inner: 8 mm Design of mounting device: Mounting clamp Fastening, at system: Screw type, Through-hole mounting Mounting bracket, at device: insertable, Clampable with limit stop Type of mounting device: Clampable, With limit stop Material: Metal
	50111497	MC 008K	Clamp	Diameter, inner: 8 mm Design of mounting device: Mounting clamp Fastening, at system: Through-hole mounting Mounting bracket, at device: Clampable Type of mounting device: Rigid Material: Plastic

Part no.: 50109640 – IS 208MM/4NO-1E5-S8.3 – Inductive switch

**Note**

A list with all available accessories can be found on the Leuze electronic website in the Download tab of the article detailed page.