

## M12 Y-distributor / M8 female 0°

PUR 3x0.25 gy UL/CSA+drag chain 5m

Male straight to female straight  
Y-connector M12 - M8, 4-pole

Plastic housings with good resistance against chemicals and oils. The resistance to aggressive media should be individually tested for your application. Further details on request. Further cable lengths on request.

### [Link to Product](#)

#### Illustration

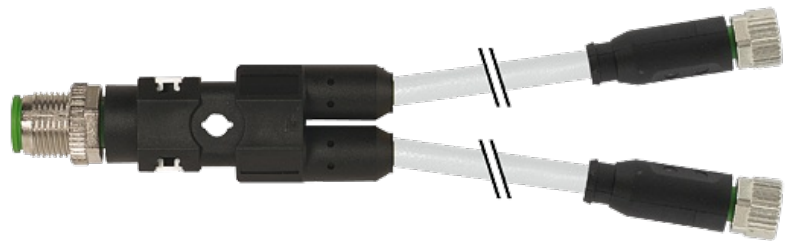

Y-Male

Females

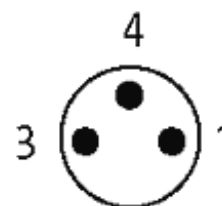

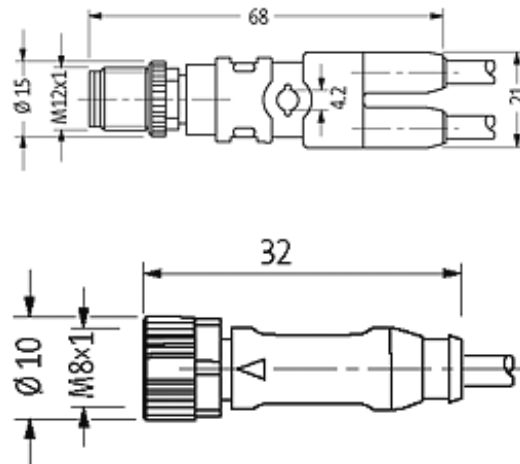

Product may differ from Image

### Approvals



### Form

40821

### Technical Data

Operating voltage	max. 60 V AC/DC
Operating current per contact	max. 4 A
Locking of ports	Screw thread M8/M12 × 1 mm (recommended torque 0.4/0.6 Nm), self-securing
Protection	IP67 inserted and tightened (EN 60529)

### Cables

Cable number	230
No./diameter of wires	3 × 0.25 mm <sup>2</sup>
Wire isolation	PP (br, bl, bk)
C-track properties	5 Mio.
Torsion	2 Mio. ± 180°/m
Jacket Color	gray
Shore hardness outer jacket	90 ± 5A
Material (jacket)	PUR (UL/CSA)
Outer diameter	approx. 4.3 mm
Bend radius (fixed)	5 × outer Ø
Bend radius (moving)	10 × outer Ø
Temperature range (fixed)	-40...+80 °C
Temperature range (mobile)	-25...+80 °C

### Commercial data

country of origin DE

---

customs tariff number	85444290
minimum order quantity	1

---