

Printed circuit board relay, bistable

OB 5693, OB 5694



- according to IEC/EN 60 669-1
- OB 5693: horizontal model
OB 5694: vertical model
- bistable, mechanical latching of contact
- same pulse (energy and direction) for both switching positions
- safe separation according to IEC/EN 61 140, IEC/EN 60 335
- AC and DC - model
- Patent on function principle
- on request wash proof
- switching reliability acc. to IEC/EN 60 669-2-2

Applications

- Remote switch
- Switching of sockets

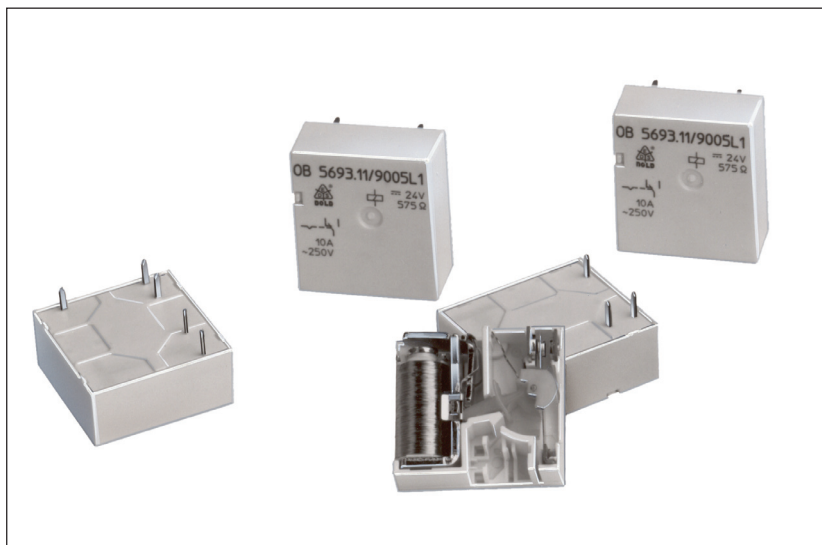

Technical data

Relay type			
1. 0 Relay coil			
1. 1 Nominal voltage	AC V	12, 24, 42, 230	50/60 Hz
	DC V	6, 12, 15, 24, 48, 60, 110	
1. 2 Nominal consumption	W/VA	1 / 1,4	
2. 0 Contacts			
2. 1 Contact arrangement	1 changeover contact or 1 NO		
2. 2 Contact material	AgNi 10, AgSnO ₂		
2. 3 Rated insulation voltage	AC V	250	
Switching voltage min./max.	AC V	10 / 400	
2. 4 Limiting continuous current I _{th}	A	16	
Switching current min./max.	A	10 mA ¹⁾ / 50 (20 ms)	
2. 5 Switching power min./max.	VA	3 / 4000	
Switching power min./max.	W	35 / 300	
Incandescent lamp load	W	1500	
2. 7 Electrical life			at 1 s On ; 1 s Off
at AC 250 V 16 A cos φ = 1	switching cycles	≥ 5 x 10 ⁴	
2. 8 max. switching frequency	switching cycles/s	5	
2.10 Contact force	cN	≥ 8	
2.14 Contact gap	mm	≥ 0,5	
3. 0 Other			
3. 1 Mechanical life	switching cycles	DC ≥ 10 x 10 ⁶ , AC ≥ 1 x 10 ⁵	
3. 2 Temperature range	°C	- 40 ... + 50	
3. 3 Degree of protection	IP 40, optionally IP 67		IEC/EN 60 529
3. 4 Housing material	PA and PBT		
3. 5 Vibration resistance	5 g, to max. 100 Hz		
3. 6 Climate resistance	25 / 050/ 04 (climate category); A/B/D IEC/EN 60 068-1		

If no limit values stated the above values are typical values for the mean value. All values are related to 20°C and for new products.

¹⁾ Typical values

²⁾ Only valid for the stated temperature range (≅ EN 61 810) different values (derating) see operating voltage limit curve

Technical data

3. 8 Insulation according to IEC 60 664-1

Rated insulation voltage	AC V	250
Contamination level		3
Overvoltage category		III
Test voltage	Contact-coil (1 min)	AC kV eff. ≥ 4
	Contact-contact (1 min)	AC kV eff. $\geq 1,5$
Transient volt.	Contact-coil (1,2 - 50 μ s)	kV ≥ 6
Clearance and creepage distances as per IEC/EN 60 730, IEC/EN 60 335		
	Contact-coil	≥ 8 mm

3. 9 Weight

g 15

Standard Variants OB 5693

Nominal voltage		Voltage range ²⁾ V	Resistance Ω ($\pm 10\%$)	Design version			
				AgSnO ₂		Ag Ni 10 + 0,2 μ m Au	
DC V	AC V			.01/	.11/	.01/	.11/
6		4,8 ... 6,6	38	9031L1	9001L1	9141L1	9121L1
12		9,6 ... 13,2	150	9032L1	9002L1	9142L1	9122L1
15		12 ... 16,5	220	9033L1	9003L1	9143L1	9123L1
20		16 ... 22	410	9034L1	9004L1	9144L1	9124L1
24		19,2 ... 26,4	575	9035L1	9005L1	9145L1	9125L1
48		38,4 ... 52,8	2 500	9036L1	9006L1	9146L1	9126L1
60		48 ... 66	3 600	9037L1	9007L1	9147L1	9127L1
110		88 ... 121	12 100	9038L1	9008L1	9148L1	9128L1
	12	9,6 ... 13,2	65	9182L1	9152L1	9232L1	9222L1
	24	19,2 ... 26,4	250	9181L1	9151L1	9231L1	9221L1
	42	33,6 ... 46,2	830	9183L1	9153L1	9233L1	9223L1
	230	184 ... 253	25 000	9187L1	9157L1	9235L1	9225L1

Standard Variants OB 5694

Nominal voltage		Voltage range ²⁾ V	Resistance Ω ($\pm 10\%$)	Design version			
				AgSnO ₂		Ag Ni 10 + 0,2 μ m Au	
DC V	AC V			.01/	.11/	.01/	.11/
6		4,8 ... 6,6	38	9321L1	9301L1	9331L1	9311L1
12		9,6 ... 13,2	150	9322L1	9302L1	9332L1	9312L1
15		12 ... 16,5	220	9323L1	9303L1	9333L1	9313L1
20		16 ... 22	410	9324L1	9304L1	9334L1	9314L1
24		19,2 ... 26,4	575	9325L1	9305L1	9335L1	9315L1
	12	9,6 ... 13,2	65	9422L1	9402L1	9432L1	9412L1
	24	19,2 ... 26,4	250	9423L1	9403L1	9433L1	9413L1
	42	33,6 ... 46,2	830	9424L1	9404L1	9434L1	9414L1
	230	184 ... 253	25 000	9425L1	9405L1	9435L1	9415L1

Ordering example

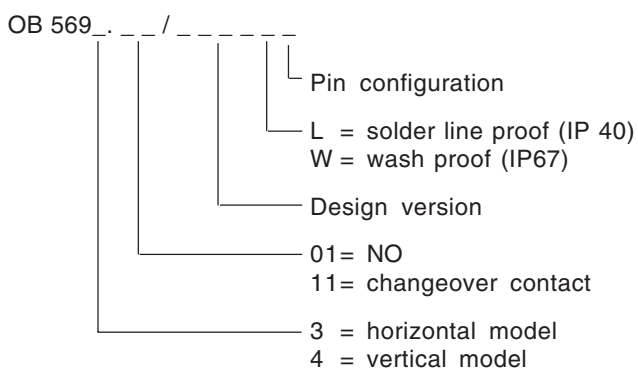

Characteristics

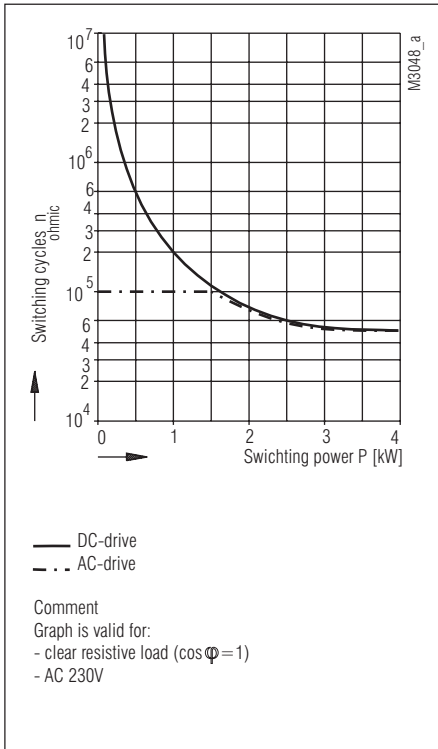

Contact service life

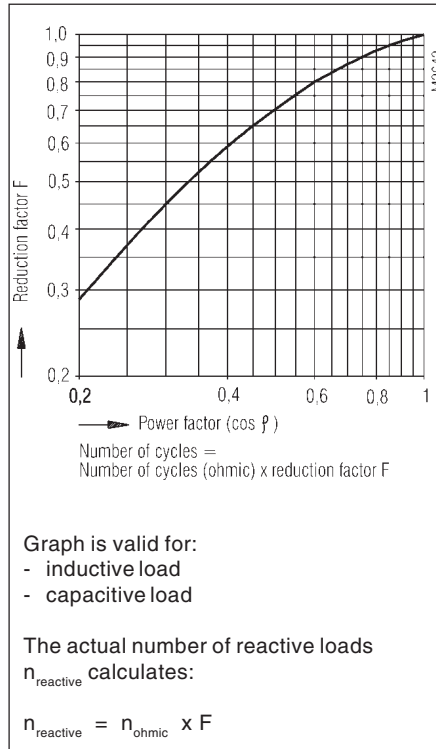

Reduction factor for reactive loads

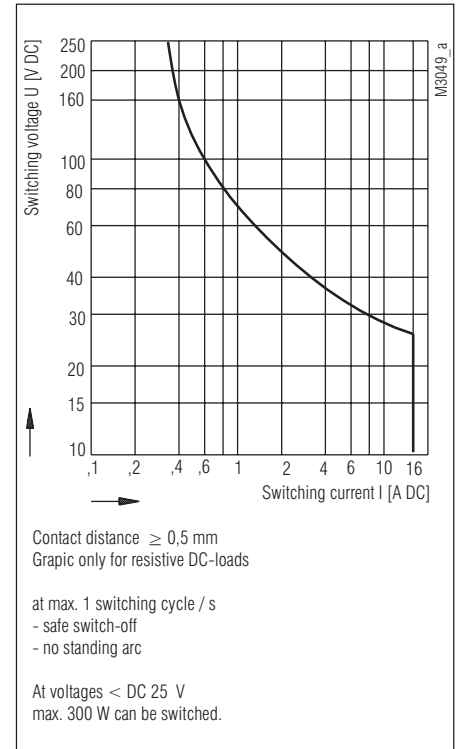

Limit curve for arc-free operation

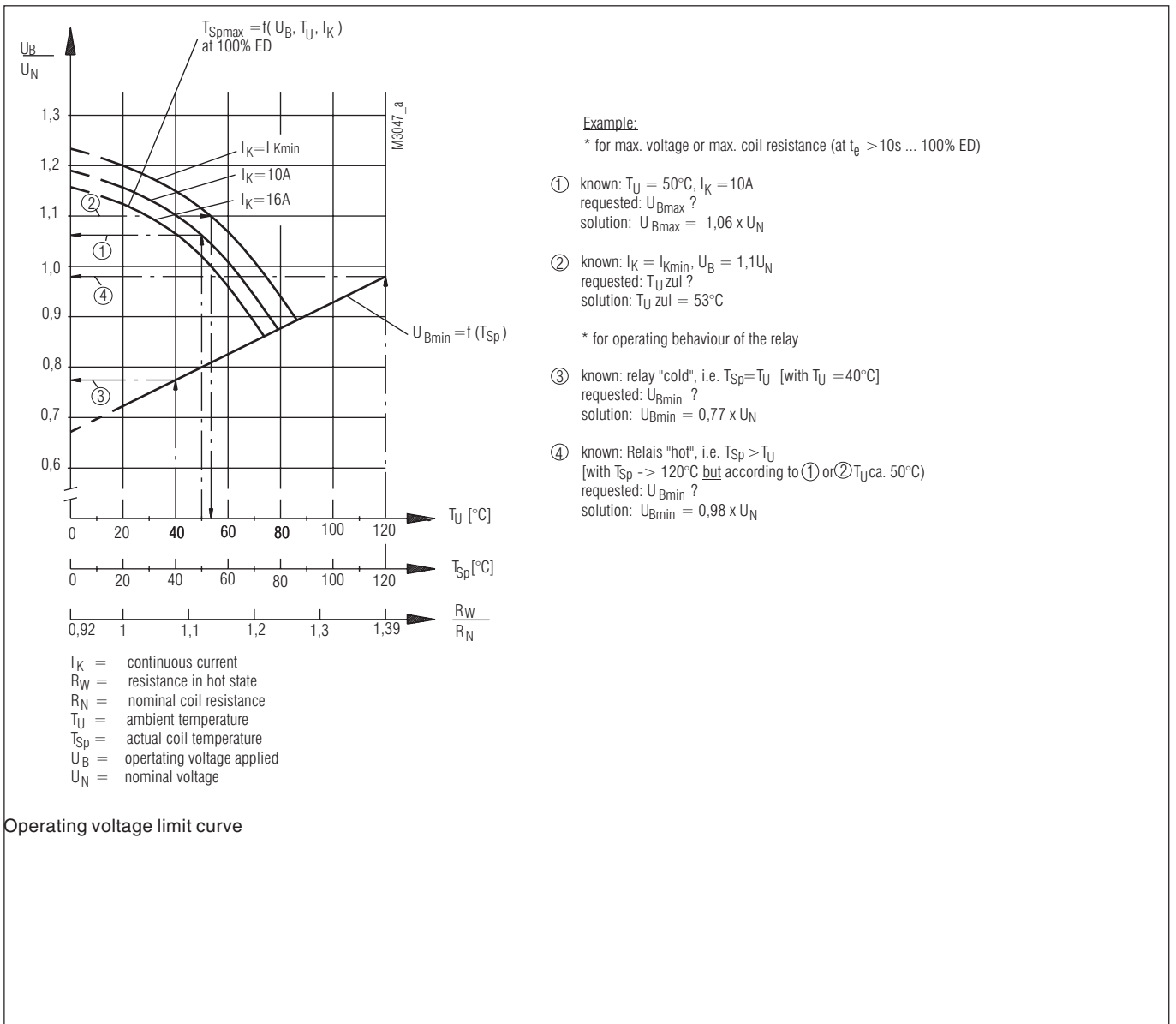

Operating voltage limit curve

Function diagram

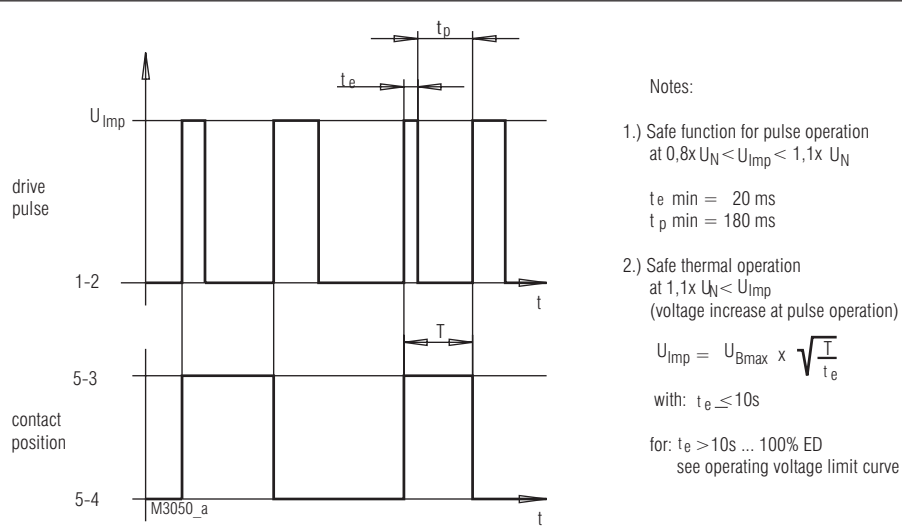

Dimensions, pin configuration, connection diagrams

Drilling plan (solder side)

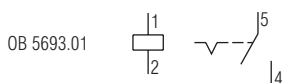
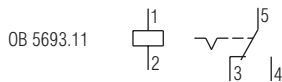
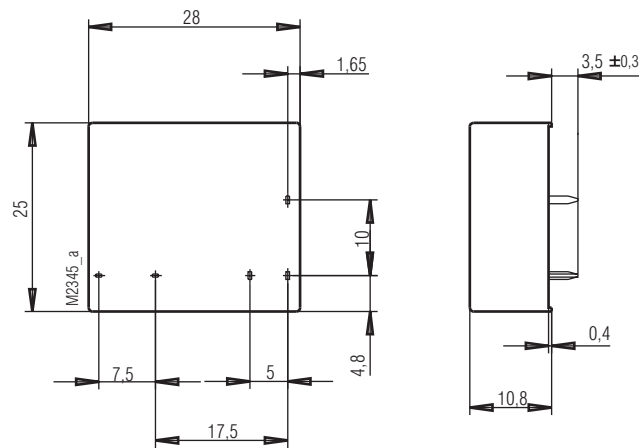
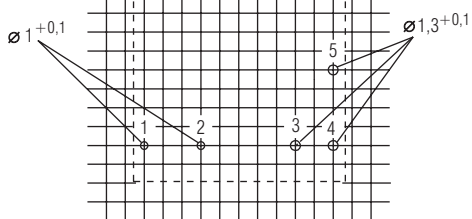
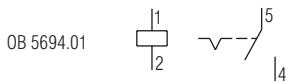
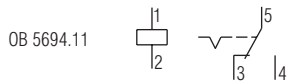
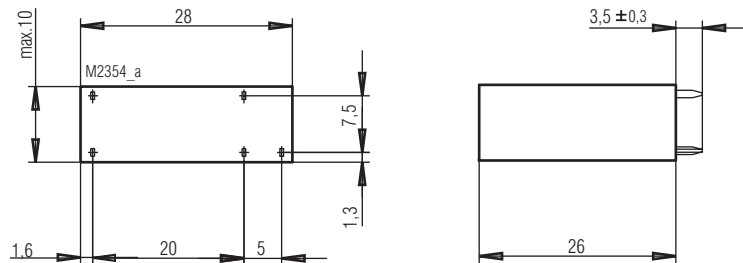
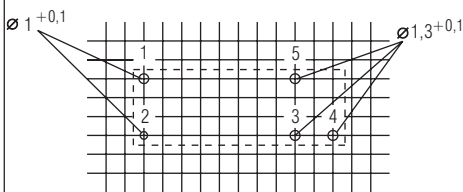

Connection for basic grid dimensions 2,5 mm as well as 2,54 mm according to IEC/EN 60 097 and IEC 60 326 average