

Operational Amplifier

# High Speed CMOS Operational Amplifier

## LMR1701G-LB

### General Description

This is the product guarantees long time support in Industrial market. And it is suitable for usage of industrial applications.

LMR1701G-LB is an output full swing CMOS operational amplifier featuring wide bandwidth, high slew rate, low operating supply voltage and low input bias current. It is suitable for a sensor amplifier and ADC input buffer amplifier.

### Features

- Long Time Support Product for Industrial Applications.
- Wide Bandwidth
- High Slew Rate
- Low Input Bias Current
- Output Full Swing
- Shutdown Function

### Applications

- Industrial Equipment
- ADC Input Buffer Amplifier
- DAC Output Amplifier
- Sensor Amplifiers
- Active Filtering
- Amplifiers

### Key Specifications

- Gain Bandwidth Product: 150 MHz (Typ)
- Slew Rate: 80 V/μs (Typ)
- Common-mode Input Voltage Range:  $V_{SS}$  to  $V_{DD} - 0.9$  V
- Input Bias Current: 2.6 pA (Typ)
- Operating Supply Voltage
  - Single Supply: 2.7 V to 5.5 V
  - Dual Supply:  $\pm 1.35$  V to  $\pm 2.75$  V
- Operating Temperature Range: -40 °C to +125 °C

### Package

SSOP6

### W (Typ) x D (Typ) x H (Max)

2.9 mm x 2.8 mm x 1.25 mm

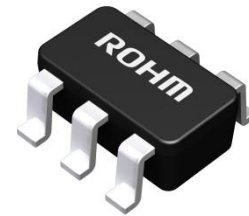

### Typical Application Circuit

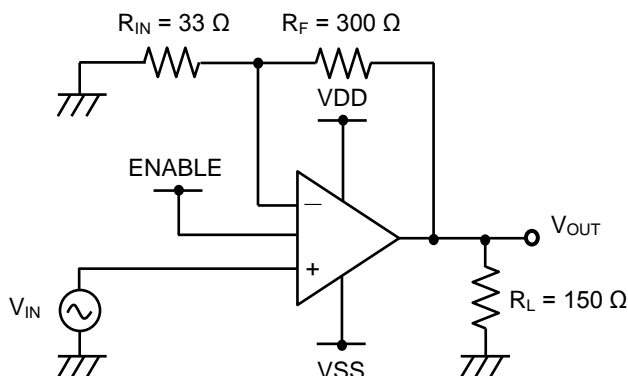

$$V_{OUT} = \left(1 + \frac{R_F}{R_{IN}}\right) V_{IN}$$

Pin Configuration

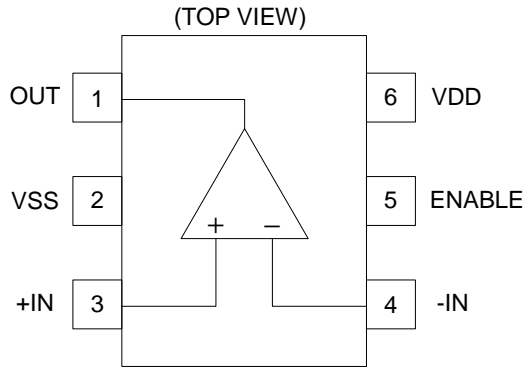

Pin Description

Pin No.	Pin Name	Function
1	OUT	Output
2	VSS	Negative power supply / Ground
3	+IN	Non-inverting input
4	-IN	Inverting input
5	ENABLE	Enable input ( $V_{ENABLE} = V_H$ : Circuitry active / $V_{ENABLE} = V_L$ : shutdown)
6	VDD	Positive power supply

Block Diagram

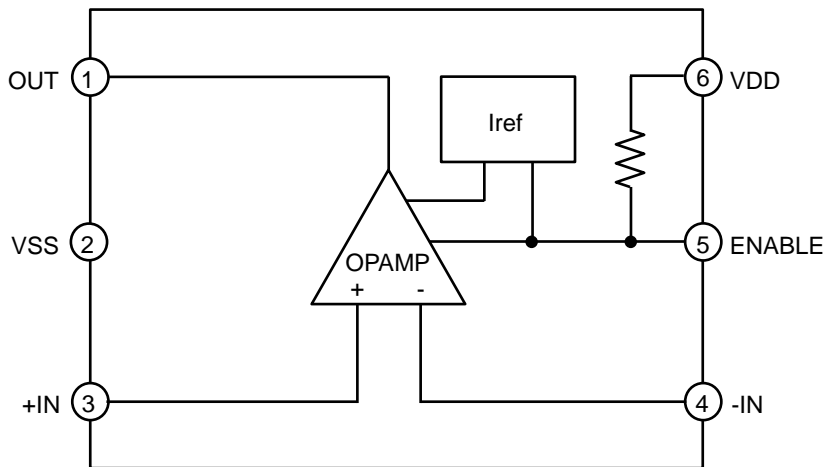

Description of Blocks

- 1. OPAMP:**  
This block includes output full swing operational amplifier with class AB output circuit and high speed ground sense differential input stage.
- 2. Iref:**  
This block supplies reference current to operate OPAMP block.

## Absolute Maximum Ratings (Ta = 25 °C)

Parameter	Symbol	Rating	Unit
Supply Voltage (V <sub>DD</sub> - V <sub>SS</sub> )	V <sub>S</sub>	7.0	V
Differential Input Voltage <sup>(Note 1)</sup>	V <sub>ID</sub>	V <sub>S</sub>	V
Common-mode Input Voltage Range	V <sub>ICMR</sub>	(V <sub>SS</sub> - 0.3) to (V <sub>DD</sub> + 0.3)	V
ENABLE Input Voltage Range	V <sub>EN</sub>	(V <sub>SS</sub> - 0.3) to (V <sub>DD</sub> + 0.3)	V
Input Current	I <sub>I</sub>	±10	mA
Maximum Junction Temperature	T <sub>Jmax</sub>	150	°C
Storage Temperature Range	T <sub>stg</sub>	-55 to +150	°C

**Caution 1:** Operating the IC over the absolute maximum ratings may damage the IC. The damage can either be a short circuit between pins or an open circuit between pins and the internal circuitry. Therefore, it is important to consider circuit protection measures, such as adding a fuse, in case the IC is operated over the absolute maximum ratings.

**Caution 2:** Should by any chance the maximum junction temperature rating be exceeded the rise in temperature of the chip may result in deterioration of the properties of the chip. In case of exceeding this absolute maximum rating, design a PCB with thermal resistance taken into consideration by increasing board size and copper area so as not to exceed the maximum junction temperature rating.

(Note 1) The differential input voltage indicates the voltage difference between inverting input and non-inverting input.  
The input pin voltage is set to V<sub>SS</sub> or more.

Thermal Resistance <sup>(Note 2)</sup>

Parameter	Symbol	Thermal Resistance (Typ)		Unit
		1s <sup>(Note 4)</sup>	2s2p <sup>(Note 5)</sup>	
SSOP6				
Junction to Ambient	θ <sub>JA</sub>	376.5	185.4	°C/W
Junction to Top Characterization Parameter <sup>(Note 3)</sup>	Ψ <sub>JT</sub>	40	30	°C/W

(Note 2) Based on JE5D51-2A(Still-Air).

(Note 3) The thermal characterization parameter to report the difference between junction temperature and the temperature at the top center of the outside surface of the component package.

(Note 4) Using a PCB board based on JE5D51-3.

(Note 5) Using a PCB board based on JE5D51-7.

Layer Number of Measurement Board	Material	Board Size
Single	FR-4	114.3 mm x 76.2 mm x 1.57 mmt

Top	
Copper Pattern	Thickness
Footprints and Traces	70 μm

Layer Number of Measurement Board	Material	Board Size
4 Layers	FR-4	114.3 mm x 76.2 mm x 1.6 mmt

Top		2 Internal Layers		Bottom	
Copper Pattern	Thickness	Copper Pattern	Thickness	Copper Pattern	Thickness
Footprints and Traces	70 μm	74.2 mm x 74.2 mm	35 μm	74.2 mm x 74.2 mm	70 μm

## Recommended Operating Conditions

Parameter	Symbol	Min	Typ	Max	Unit
Supply Voltage (V <sub>DD</sub> - V <sub>SS</sub> )	Single Supply	2.7	5.0	5.5	V
	Dual Supply	±1.35	±2.50	±2.75	
Operating Temperature	Topr	-40	+25	+125	°C

## Electrical Characteristics

(Unless otherwise specified  $V_S = 5.5\text{ V}$ ,  $V_{SS} = 0\text{ V}$ ,  $R_L = 150\ \Omega$  to  $V_S/2$ )

Parameter	Symbol	Temperature Range	Limit			Unit	Conditions
			Min	Typ	Max		
Input Offset Voltage	$V_{IO}$	25 °C	-	1	6	mV	Absolute value
		-40 °C to +125 °C	-	-	8		
Input Offset Voltage Temperature Drift	$\Delta V_{IO}/\Delta T$	-40 °C to +125 °C	-	2.5	-	$\mu\text{V}/^\circ\text{C}$	Absolute value
Input Offset Current	$I_{IO}$	25 °C	-	0.2	-	pA	Absolute value
Input Bias Current	$I_B$	25 °C	-	2.6	-	pA	Absolute value
Supply Current	$I_{DD}$	25 °C	-	9.6	14.0	mA	-
		-40 °C to +125 °C	-	-	16.0		
Shutdown Current	$I_{DD\_SD}$	25 °C	-	0.15	1.00	$\mu\text{A}$	-
Common-mode Rejection Ratio	CMRR	-40 °C to +125 °C	66	80	-	dB	$V_{ICMR} = 0.0\text{ V}$ to $4.6\text{ V}$
Power Supply Rejection Ratio	PSRR	-40 °C to +125 °C	60	86	-	dB	$V_{DD} = 2.7\text{ V}$ to $5.5\text{ V}$
Common-mode Input Voltage Range	$V_{ICMR}$	25 °C	0	-	$V_{DD} - 0.9$	V	$V_{SS}$ to $V_{DD} - 0.9\text{ V}$
Large Signal Voltage Gain	$A_V$	25 °C	95	120	-	dB	$R_L = 100\ \Omega$ , $V_{OUT} = 0.5\text{ V}$ to $5.0\text{ V}$
		-40 °C to +125 °C	90	-	-	dB	
Output Voltage High	$V_{OH}$	25 °C	-	15	100	mV	$R_L = 2\text{ k}\Omega$ , $V_{OH} = V_{DD} - V_{OUT}$
			-	250	500	mV	$R_L = 100\ \Omega$ , $V_{OH} = V_{DD} - V_{OUT}$
Output Voltage Low	$V_{OL}$	25 °C	-	20	100	mV	$R_L = 2\text{ k}\Omega$
			-	150	500	mV	$R_L = 100\ \Omega$
Output Source Current <sup>(Note 1)</sup>	$I_{OH}$	25 °C	-	200	-	mA	$V_{OUT} = V_{SS}$ Absolute value
Output Sink Current <sup>(Note 1)</sup>	$I_{OL}$	25 °C	-	130	-	mA	$V_{OUT} = V_{DD}$ Absolute value
Slew Rate	SR	25 °C	-	80	-	V/ $\mu\text{s}$	$V_{OUT} = 2\text{ V}_{p-p}$ , $R_L = 150\ \Omega$
Settling Time, 0.1%	$t_s$	25 °C	-	30	-	ns	$V_{OUT} = 2\text{ V}_{step}$ , $G = 6\text{ dB}$ , $R_L = 150\ \Omega$
Gain Bandwidth Product	GBW	25 °C	-	150	-	MHz	$G = 20\text{ dB}$ , $R_L = 150\ \Omega$
Phase Margin	$\theta$	25 °C	-	50	-	deg	$G = 20\text{ dB}$ , $R_L = 150\ \Omega$
Input Referred Noise Voltage Density	$V_n$	25 °C	-	3	-	nV/ $\sqrt{\text{Hz}}$	$f = 1\text{ MHz}$ , $R_L = 150\ \Omega$
Total Harmonic Distortion + Noise	THD+N	25 °C	-	0.003	-	%	$f = 1\text{ kHz}$ , $G = 6\text{ dB}$ , $V_{OUT} = 3\text{ V}_{p-p}$ , $R_L = 150\ \Omega$
Turn On Time	$t_{ON}$	25 °C	-	5	-	$\mu\text{s}$	-
Turn Off Time	$t_{OFF}$	25 °C	-	20	-	ns	-
Turn On Voltage <sup>(Note 2,3)</sup>	$V_H$	25 °C	2.5	-	5.5	V	-
Turn Off Voltage <sup>(Note 2,4)</sup>	$V_L$	25 °C	0	-	0.8	V	-

(Note 1) Select the output current value that consider the power dissipation of the IC under high temperature environment. When the output pins are short-circuited continuously, the output current may decrease due to the temperature rise by the heat generation of inside the IC.

(Note 2) When the ENABLE pin is not connected to any potential, the ENABLE pin pulled up to  $V_{DD}$  potential by the internal circuit in IC and normally operable.

(Note 3) The ENABLE input voltage required that the IC is active.

(Note 4) The ENABLE input voltage required that the IC is shutdown.

## Electrical Characteristics – continued

(Unless otherwise specified  $V_S = 2.7\text{ V}$ ,  $V_{SS} = 0\text{ V}$ ,  $R_L = 150\ \Omega$  to  $V_S/2$ )

Parameter	Symbol	Temperature Range	Limit			Unit	Conditions
			Min	Typ	Max		
Input Offset Voltage	$V_{IO}$	25 °C	-	1	6	mV	Absolute value
		-40 °C to +125 °C	-	-	8		
Input Offset Voltage Temperature Drift	$\Delta V_{IO}/\Delta T$	-40 °C to +125 °C	-	2.5	-	$\mu\text{V}/^\circ\text{C}$	Absolute value
Input Offset Current	$I_{IO}$	25 °C	-	0.2	-	pA	Absolute value
Input Bias Current	$I_B$	25 °C	-	2.6	-	pA	Absolute value
Supply Current	$I_{DD}$	25 °C	-	8.7	13.0	mA	-
		-40 °C to +125 °C	-	-	14.5		
Shutdown Current	$I_{DD\_SD}$	25 °C	-	0.15	1.00	$\mu\text{A}$	-
Common-mode Rejection Ratio	CMRR	-40 °C to +125 °C	60	80	-	dB	$V_{ICMR} = 0.0\text{ V}$ to 1.8 V
Power Supply Rejection Ratio	PSRR	-40 °C to +125 °C	60	86	-	dB	$V_{DD} = 2.7\text{ V}$ to 5.5 V
Common-mode Input Voltage Range	$V_{ICMR}$	25 °C	0	-	$V_{DD} - 0.9$	V	$V_{SS}$ to $V_{DD} - 0.9\text{ V}$
Large Signal Voltage Gain	$A_V$	25 °C	90	120	-	dB	$R_L = 100\ \Omega$ , $V_{OUT} = 0.5\text{ V}$ to 2.2 V
		-40 °C to +125 °C	90	-	-	dB	
Output Voltage High	$V_{OH}$	25 °C	-	10	100	mV	$R_L = 2\text{ k}\Omega$ , $V_{OH} = V_{DD} - V_{OUT}$
			-	150	500	mV	$R_L = 100\ \Omega$ , $V_{OH} = V_{DD} - V_{OUT}$
Output Voltage Low	$V_{OL}$	25 °C	-	5	100	mV	$R_L = 2\text{ k}\Omega$
			-	70	500	mV	$R_L = 100\ \Omega$
Output Source Current <sup>(Note 1)</sup>	$I_{OH}$	25 °C	-	60	-	mA	$V_{OUT} = V_{SS}$ Absolute value
Output Sink Current <sup>(Note 1)</sup>	$I_{OL}$	25 °C	-	120	-	mA	$V_{OUT} = V_{DD}$ Absolute value
Slew Rate	SR	25 °C	-	70	-	V/ $\mu\text{s}$	$V_{OUT} = 1\text{ V}_{p-p}$ , $R_L = 150\ \Omega$
Settling Time, 0.1%	$t_s$	25 °C	-	30	-	ns	$V_{OUT} = 1\text{ V}_{step}$ , $G = 6\text{ dB}$ , $R_L = 150\ \Omega$
Gain Bandwidth Product	GBW	25 °C	-	140	-	MHz	$G = 20\text{ dB}$ , $R_L = 150\ \Omega$
Phase Margin	$\theta$	25 °C	-	50	-	deg	$G = 20\text{ dB}$ , $R_L = 150\ \Omega$
Input Referred Noise Voltage Density	$V_n$	25 °C	-	3	-	nV/ $\sqrt{\text{Hz}}$	$f = 1\text{ MHz}$ , $R_L = 150\ \Omega$
Total Harmonic Distortion + Noise	THD+N	25 °C	-	0.0015	-	%	$f = 1\text{ kHz}$ , $G = 6\text{ dB}$ , $V_{OUT} = 1\text{ V}_{p-p}$ , $R_L = 150\ \Omega$
Turn On Time	$t_{ON}$	25 °C	-	10	-	$\mu\text{s}$	-
Turn Off Time	$t_{OFF}$	25 °C	-	20	-	ns	-
Turn On Voltage <sup>(Note 2,3)</sup>	$V_H$	25 °C	2.5	-	2.7	V	-
Turn Off Voltage <sup>(Note 2,4)</sup>	$V_L$	25 °C	0	-	0.8	V	-

(Note 1) Select the output current value that consider the power dissipation of the IC under high temperature environment. When the output pins are short-circuited continuously, the output current may decrease due to the temperature rise by the heat generation of inside the IC.

(Note 2) When the ENABLE pin is not connected to any potential, the ENABLE pin pulled up to  $V_{DD}$  potential by the internal circuit in IC and normally operable.

(Note 3) The ENABLE input voltage required that the IC is active.

(Note 4) The ENABLE input voltage required that the IC is shutdown.

## Description of Terms in Electrical Characteristics

Described below are descriptions of the relevant electrical terms used in this datasheet. Items and symbols generally used are also shown. Note that item names, symbols and their meanings may differ from those on another manufacturer's or general documents.

### 1. Absolute Maximum Ratings

Absolute maximum rating items indicates the condition which must not be exceeded even if it is instantaneous. Applying of a voltage exceeding the absolute maximum ratings or use outside the temperature range which is provided in the absolute maximum ratings cause characteristic deterioration or destruction of the IC.

#### 1.1 Supply Voltage ( $V_S$ )

This indicates the maximum voltage that can be applied between the positive power supply pin and the negative power supply pin without deteriorating the characteristics of internal circuit or without destroying it.

#### 1.2 Differential Input Voltage ( $V_{ID}$ )

This indicates the maximum voltage that can be applied between the non-inverting input pin and the inverting input pin without deteriorating the characteristics of the IC or without destroying it.

#### 1.3 Common-mode Input Voltage Range ( $V_{ICMR}$ )

This indicates the maximum voltage that can be applied to the non-inverting input pin and inverting input pin without deteriorating the characteristics of the IC or without destroying it. Common-mode Input Voltage Range of the maximum ratings does not assure normal operation of IC. For normal operation, use the IC within the Common-mode Input Voltage Range on Electrical Characteristics.

### 2. Electrical Characteristics

#### 2.1 Input Offset Voltage ( $V_{IO}$ )

This indicates the voltage difference between non-inverting and inverting pins. It can be translated as the input voltage difference required for setting the output voltage at 0 V.

#### 2.2 Input Offset Voltage Drift ( $\Delta V_{IO} / \Delta T$ )

Denotes the ratio of the input offset voltage fluctuation to the ambient temperature fluctuation.

#### 2.3 Input Offset Current ( $I_{IO}$ )

This indicates the difference of input bias current between the non-inverting and inverting pins.

#### 2.4 Input Bias Current ( $I_B$ )

This indicates the current that flows into or out from the input pin. It is defined by the average of input bias currents at the non-inverting and inverting pins.

#### 2.5 Supply Current ( $I_{DD}$ )

This indicates the current of the IC itself flowing under the specified conditions and under no-load or steady-state conditions.

#### 2.6 Shutdown Current ( $I_{DD\_SD}$ )

This indicates the current when the circuit is shutdown.

#### 2.7 Common-mode Rejection Ratio (CMRR)

This indicates the ratio of fluctuation of input offset voltage when Common-mode Input Voltage is changed. It is normally the fluctuation of DC.

$$\text{CMRR} = (\text{Change of Input Common-mode Voltage}) / (\text{Input Offset Fluctuation})$$

#### 2.8 Power Supply Rejection Ratio (PSRR)

This indicates the ratio of fluctuation of input offset voltage when supply voltage is changed.

It is normally the fluctuation of DC.

$$\text{PSRR} = (\text{Change of Power Supply Voltage}) / (\text{Input Offset Fluctuation})$$

#### 2.9 Common-mode Input Voltage Range ( $V_{ICMR}$ )

This indicates the input voltage range where IC normally operates.

#### 2.10 Large Signal Voltage Gain ( $A_V$ )

This indicates the amplifying rate (gain) of output voltage against the voltage difference between non-inverting pin and inverting pin. It is normally the amplifying rate (gain) with reference to DC voltage.

$$A_V = (\text{Output Voltage}) / (\text{Differential Input Voltage})$$

#### 2.11 Output Voltage High / Output Voltage Low ( $V_{OH} / V_{OL}$ )

This indicates the voltage range of the output under specified load condition. It is divided into Output Voltage High and Output Voltage Low. Output Voltage High indicates the upper limit of output voltage. Output Voltage Low indicates the lower limit.

**Description of Terms in Electrical Characteristics – continued**

- 2.12 Output Source Current / Output Sink Current ( $I_{OH}$  /  $I_{OL}$ )  
The maximum current that can be output from the IC under specific output conditions. It is distributed between output source current and output sink current. The output source current indicates the current flowing out from the IC, and the output sink current indicates the current flowing into the IC.
- 2.13 Slew Rate (SR)  
This is a parameter representing the operational speed of the operational amplifier. This indicates the rate at which the output voltage can change in the specified unit time.
- 2.14 Settling Time, 0.1% ( $t_s$ )  
This indicates the time it takes the output to respond to a step change of input, and remain within a defined error band (0.1%).
- 2.15 Gain Bandwidth Product (GBW)  
This indicates the product of an arbitrary frequency and its gain in the range of the gain slope of -6 dB/octave.
- 2.16 Phase Margin ( $\theta$ )  
This indicates the margin of phase from the phase delay of 180 degree at the frequency which the gain of the operational amplifier is 1.
- 2.17 Input Referred Noise Voltage Density ( $V_n$ )  
Indicates a noise voltage generated inside the operational amplifier equivalent by ideal voltage source connected in series with input terminal.
- 2.18 Total Harmonic Distortion + Noise (THD+N)  
This indicates the content ratio of harmonic and noise components relative to the output signal.
- 2.19 Turn On Time / Turn Off Time ( $t_{ON}$  /  $t_{OFF}$ )  
Turn On Time indicates the time from applying the voltage to the ENABLE pin until the IC is active.  
Turn Off Time indicates the time from applying the voltage to the ENABLE pin until the IC is shutdown.
- 2.20 Turn On Voltage / Turn Off Voltage ( $V_H$  /  $V_L$ )  
The IC is active if the ENABLE pin is applied Turn On Voltage ( $V_H$ ).  
The IC is shutdown if the ENABLE pin is applied Turn Off Voltage ( $V_L$ ).

Typical Performance Curves

(Reference data)  $V_{SS} = 0\text{ V}$

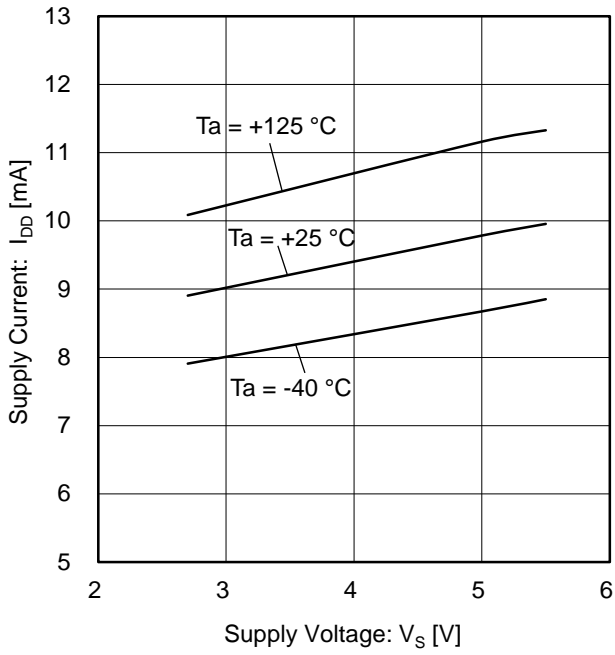

Figure 1. Supply Current vs Supply Voltage

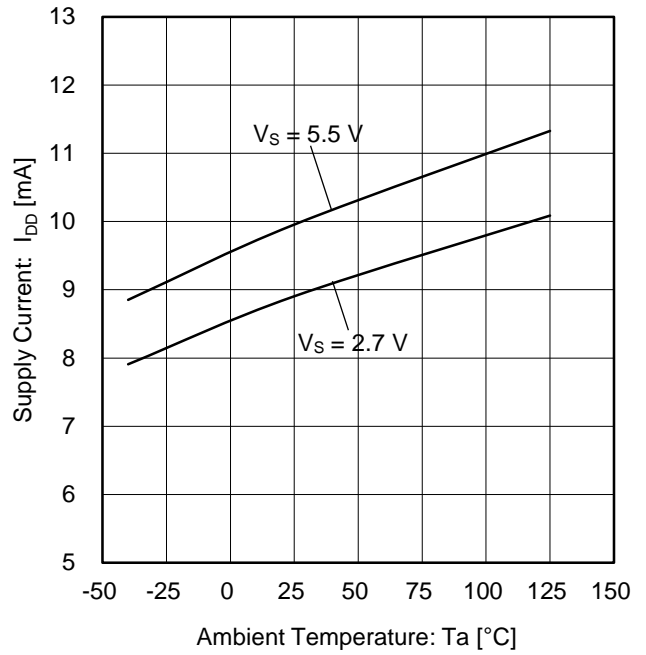

Figure 2. Supply Current vs Ambient Temperature

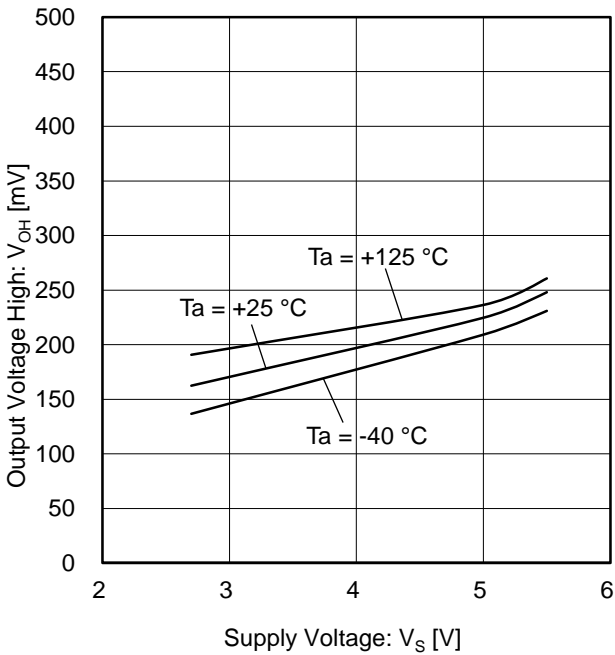

Figure 3. Output Voltage High vs Supply Voltage  
( $R_L = 100\ \Omega$ ,  $V_{OH} = V_{DD} - V_{OUT}$ )

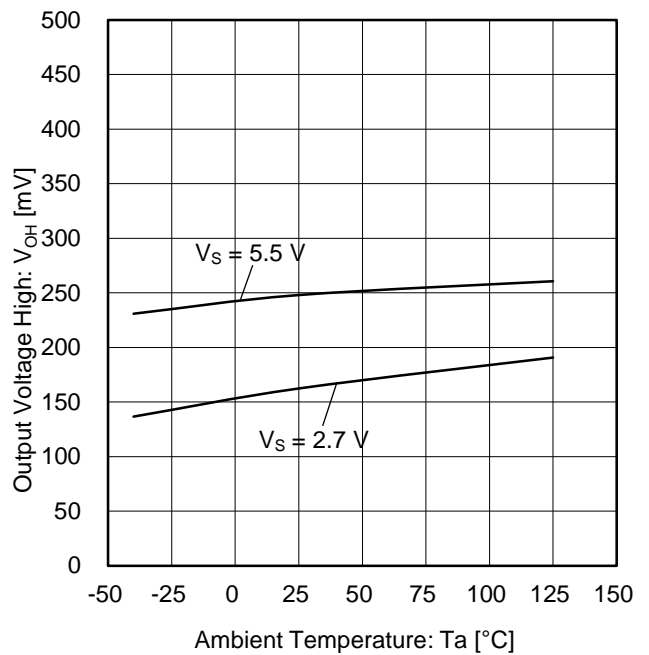

Figure 4. Output Voltage High vs Ambient Temperature  
( $R_L = 100\ \Omega$ ,  $V_{OH} = V_{DD} - V_{OUT}$ )

(Note) The above data are measurement value of typical sample; it is not guaranteed.



Typical Performance Curves – continued

(Reference data)  $V_{SS} = 0\text{ V}$

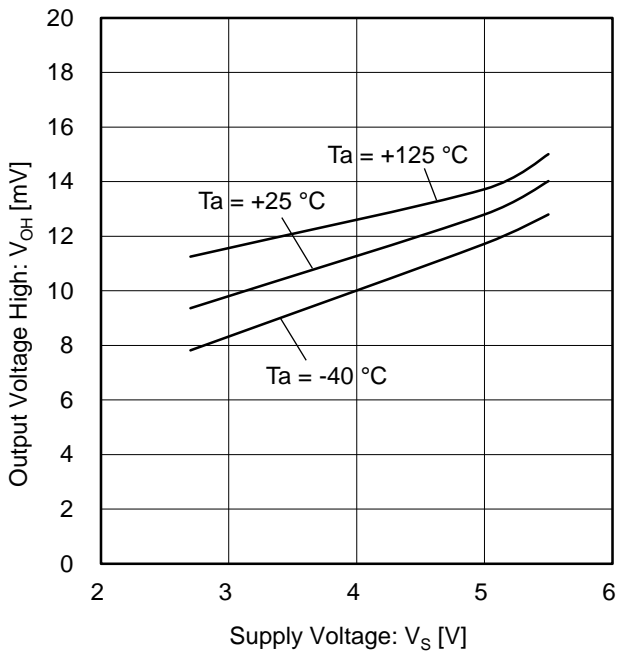

Figure 5. Output Voltage High vs Supply Voltage  
( $R_L = 2\text{ k}\Omega$ ,  $V_{OH} = V_{DD} - V_{OUT}$ )

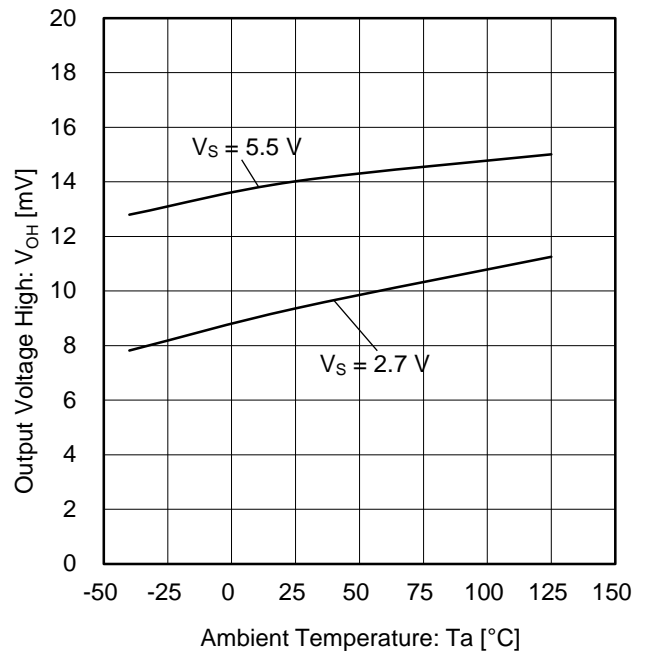

Figure 6. Output Voltage High vs Ambient Temperature  
( $R_L = 2\text{ k}\Omega$ ,  $V_{OH} = V_{DD} - V_{OUT}$ )

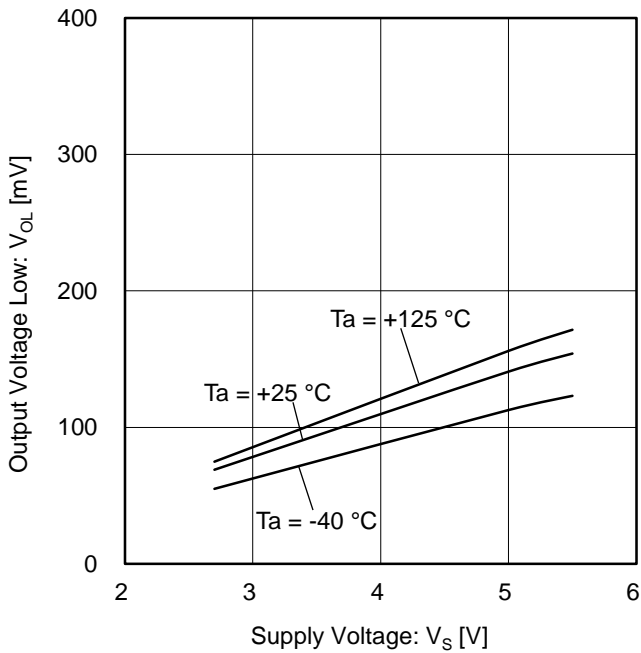

Figure 7. Output Voltage Low vs Supply Voltage  
( $R_L = 100\ \Omega$ )

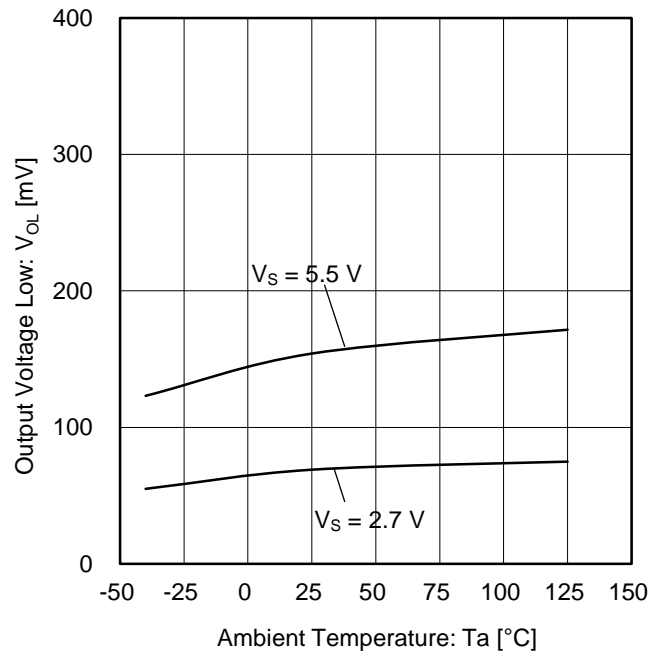

Figure 8. Output Voltage Low vs Ambient Temperature  
( $R_L = 100\ \Omega$ )

(Note) The above data are measurement value of typical sample; it is not guaranteed.

Typical Performance Curves – continued

(Reference data)  $V_{SS} = 0\text{ V}$

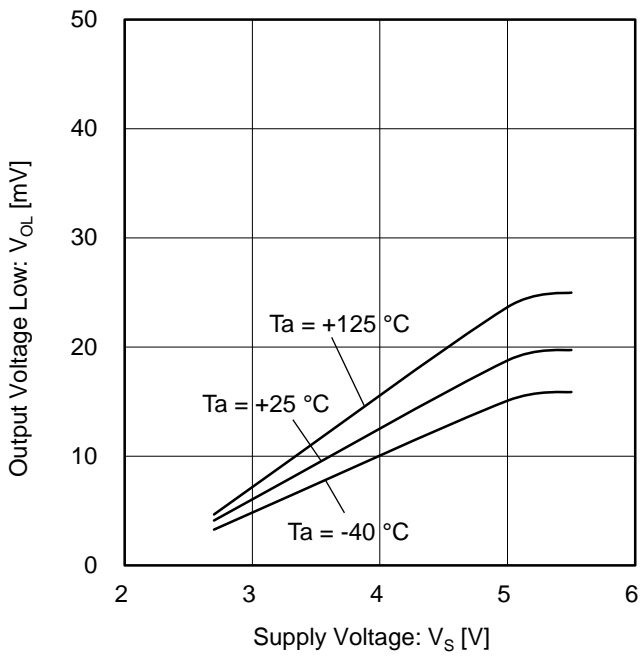

Figure 9. Output Voltage Low vs Supply Voltage ( $R_L = 2\text{ k}\Omega$ )

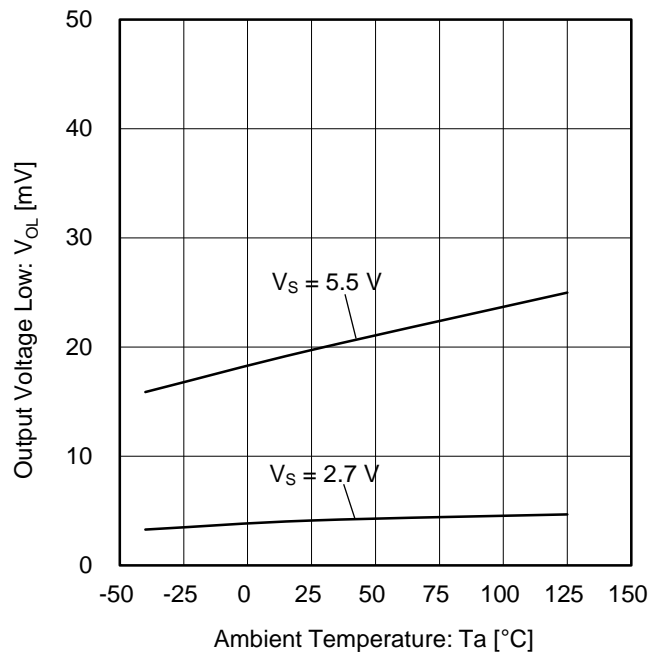

Figure 10. Output Voltage Low vs Ambient Temperature ( $R_L = 2\text{ k}\Omega$ )

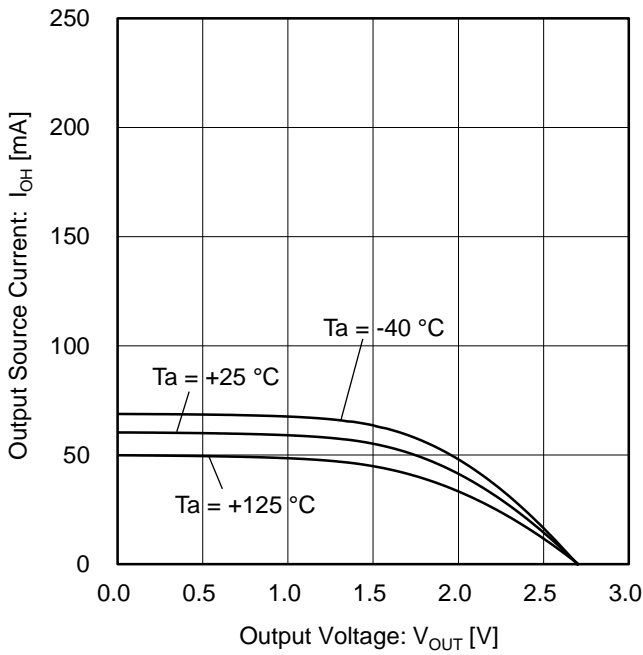

Figure 11. Output Source Current vs Output Voltage ( $V_S = 2.7\text{ V}$ )

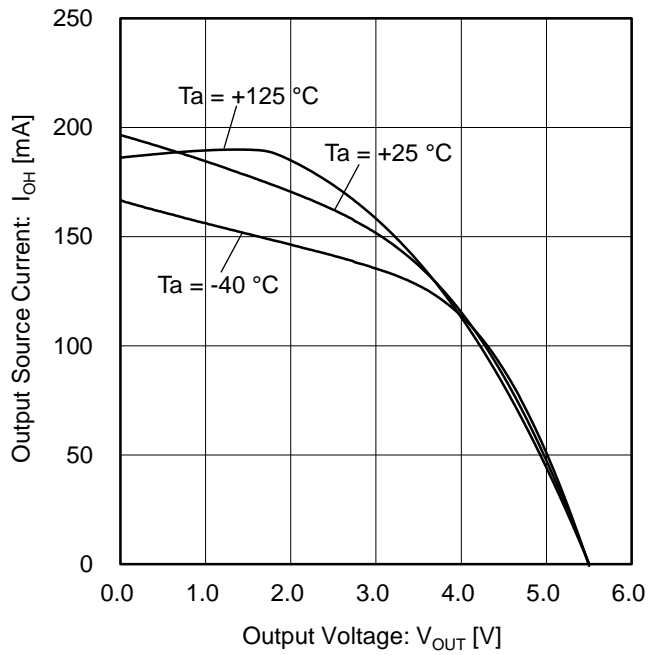

Figure 12. Output Source Current vs Output Voltage ( $V_S = 5.5\text{ V}$ )

(Note) The above data are measurement value of typical sample; it is not guaranteed.

Typical Performance Curves – continued

(Reference data)  $V_{SS} = 0\text{ V}$

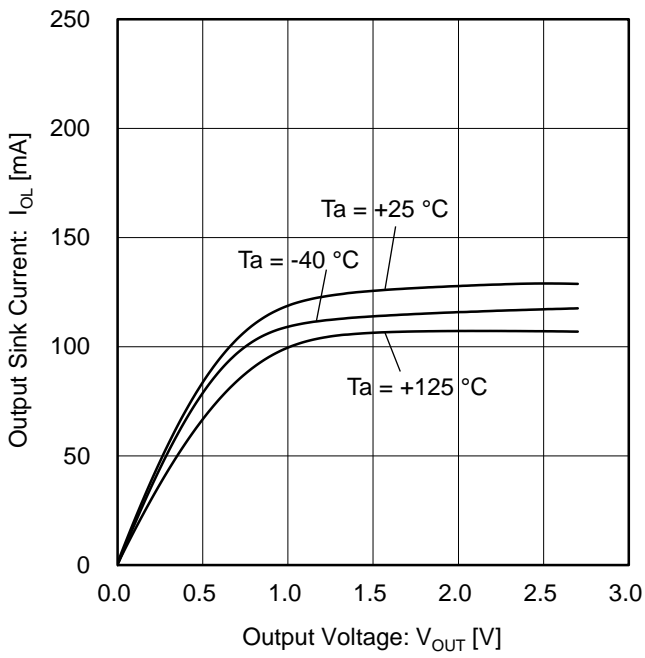

Figure 13. Output Sink Current vs Output Voltage ( $V_S = 2.7\text{ V}$ )

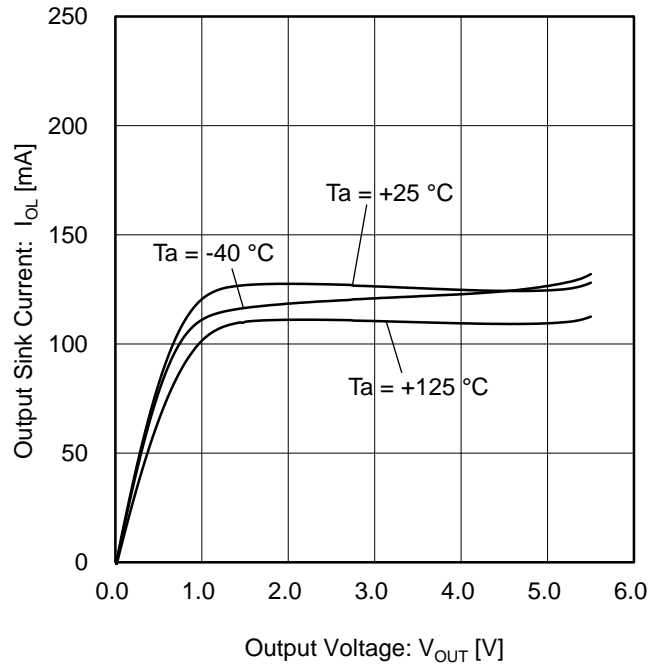

Figure 14. Output Sink Current vs Output Voltage ( $V_S = 5.5\text{ V}$ )

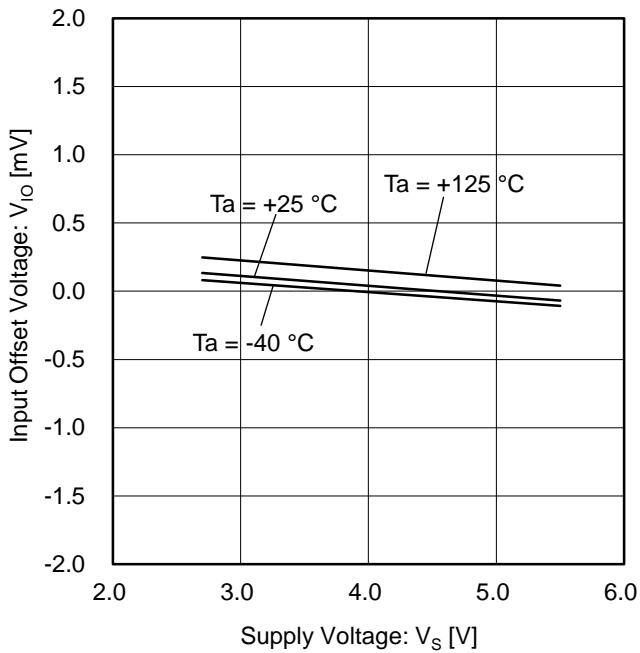

Figure 15. Input Offset Voltage vs Supply Voltage

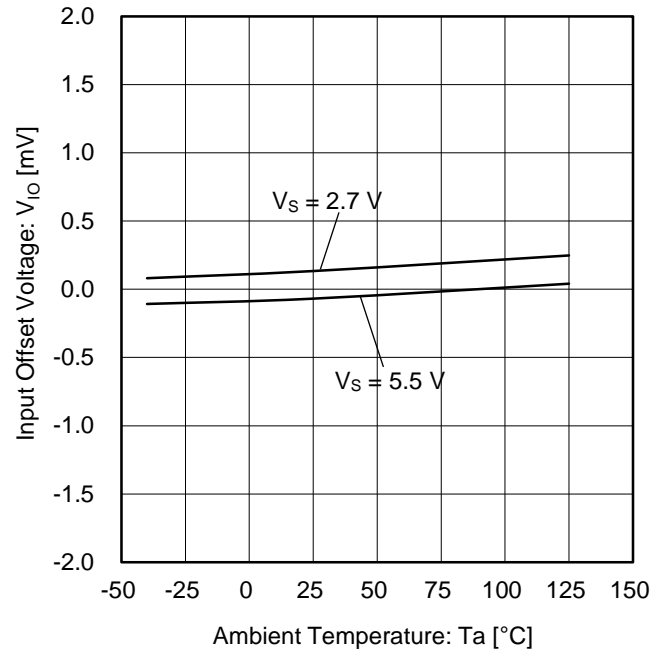

Figure 16. Input Offset Voltage vs Ambient Temperature

(Note) The above data are measurement value of typical sample; it is not guaranteed.

Typical Performance Curves – continued

(Reference data)  $V_{SS} = 0\text{ V}$

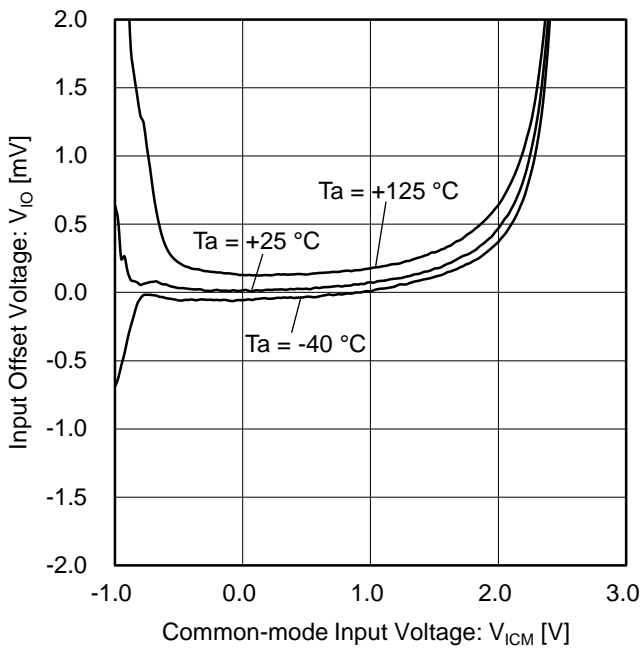

Figure 17. Input Offset Voltage vs Common-mode Input Voltage ( $V_S = 2.7\text{ V}$ )

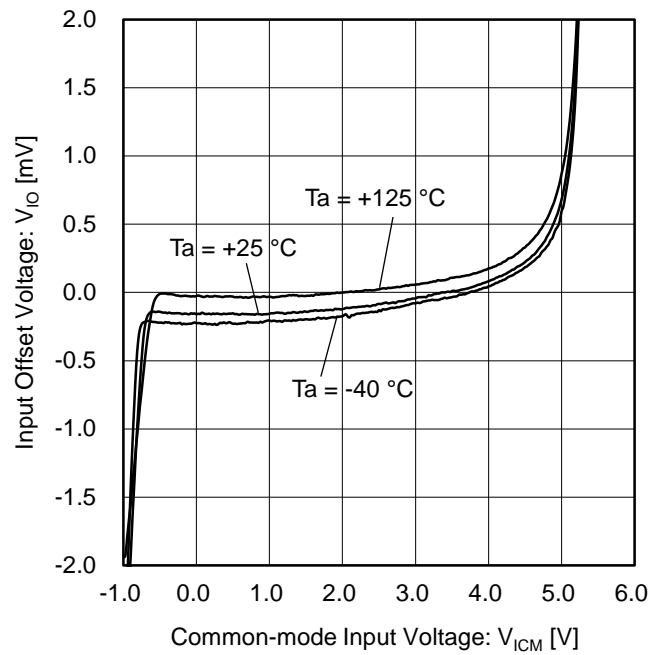

Figure 18. Input Offset Voltage vs Common-mode Input Voltage ( $V_S = 5.5\text{ V}$ )

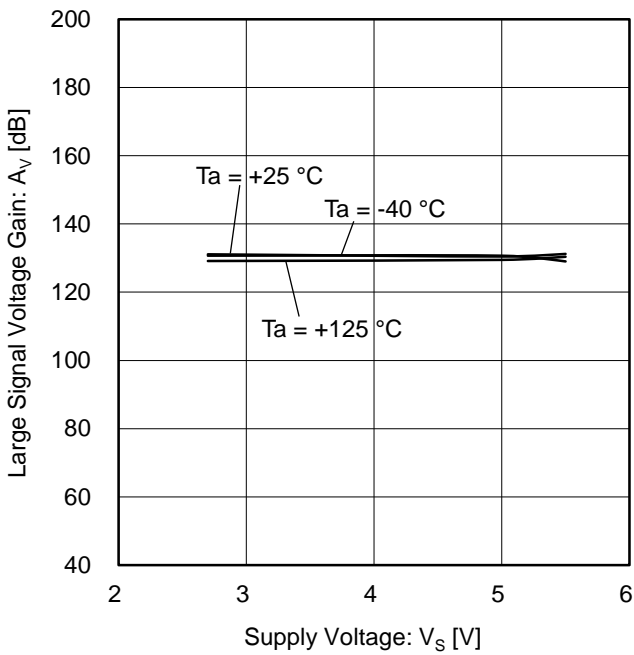

Figure 19. Large Signal Voltage Gain vs Supply Voltage ( $R_L = 2\text{ k}\Omega$ )

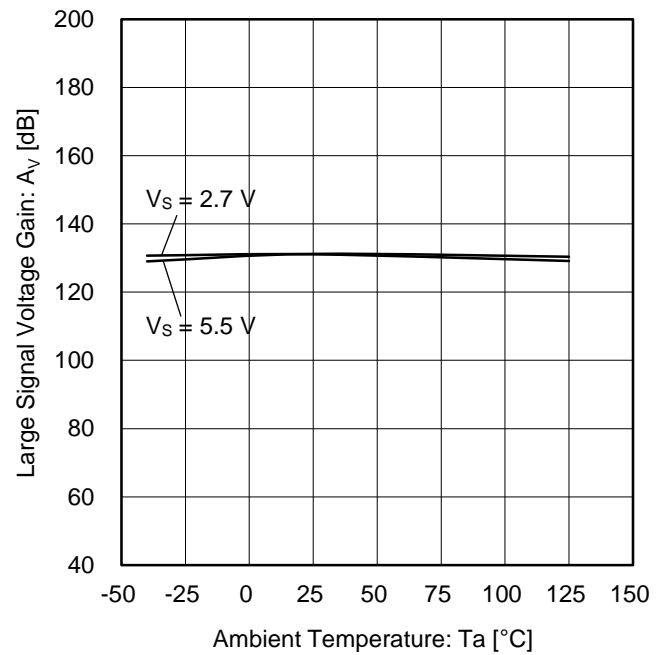

Figure 20. Large Signal Voltage Gain vs Ambient Temperature ( $R_L = 2\text{ k}\Omega$ )

(Note) The above data are measurement value of typical sample; it is not guaranteed.

Typical Performance Curves – continued

(Reference data)  $V_{SS} = 0\text{ V}$

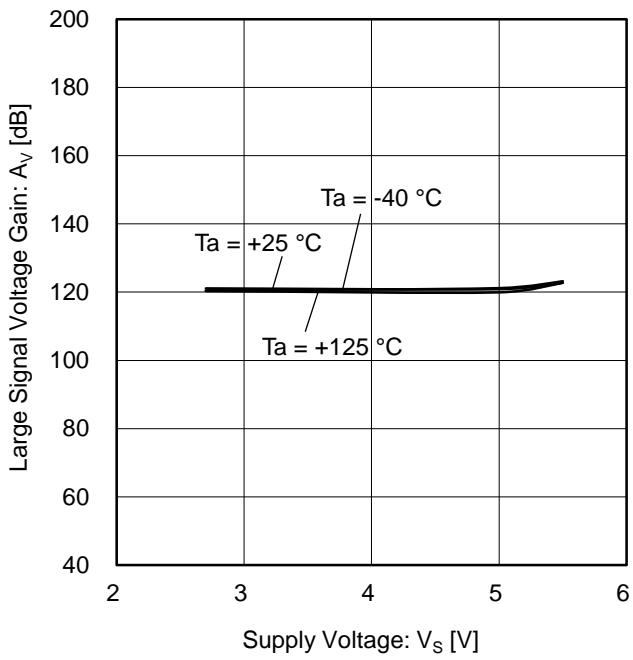

Figure 21. Large Signal Voltage Gain vs Supply Voltage ( $R_L = 100\ \Omega$ )

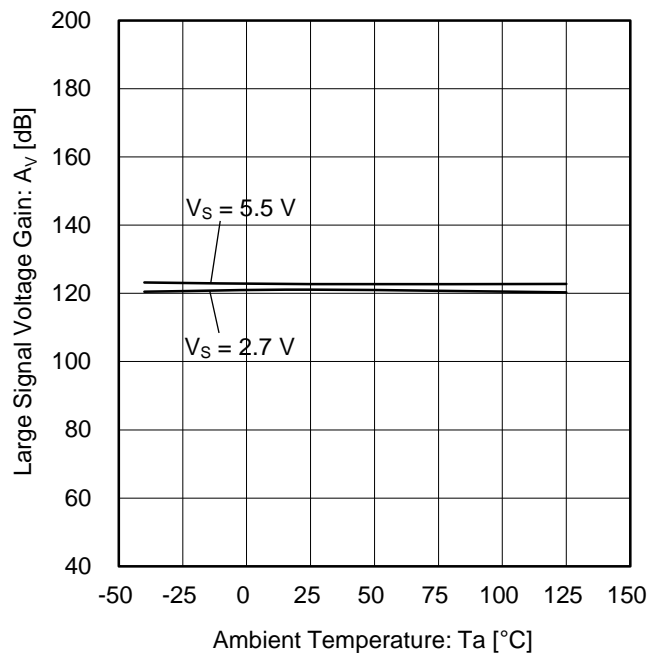

Figure 22. Large Signal Voltage Gain vs Ambient Temperature ( $R_L = 100\ \Omega$ )

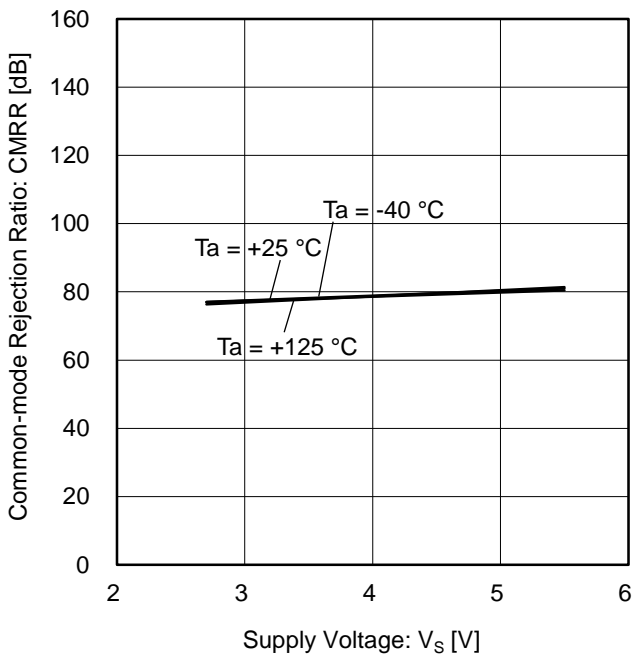

Figure 23. Common-mode Rejection Ratio vs Supply Voltage

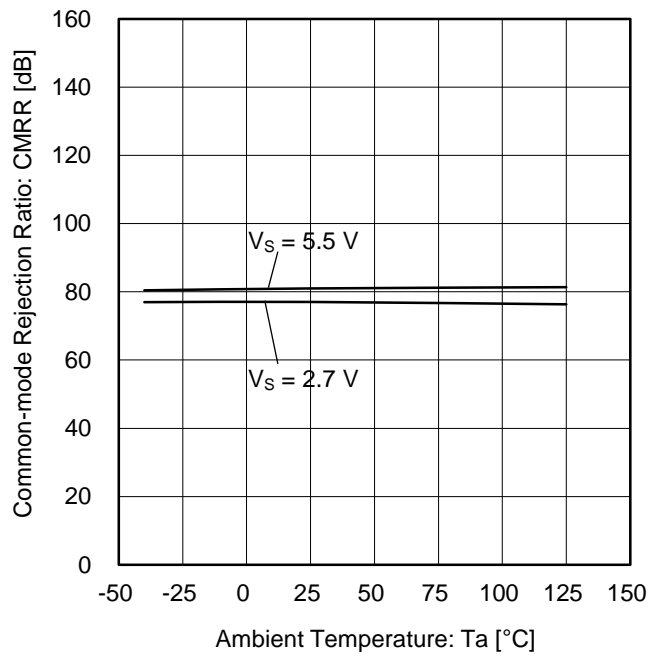

Figure 24. Common-mode Rejection Ratio vs Ambient Temperature

(Note) The above data are measurement value of typical sample; it is not guaranteed.

Typical Performance Curves – continued

(Reference data)  $V_{SS} = 0\text{ V}$

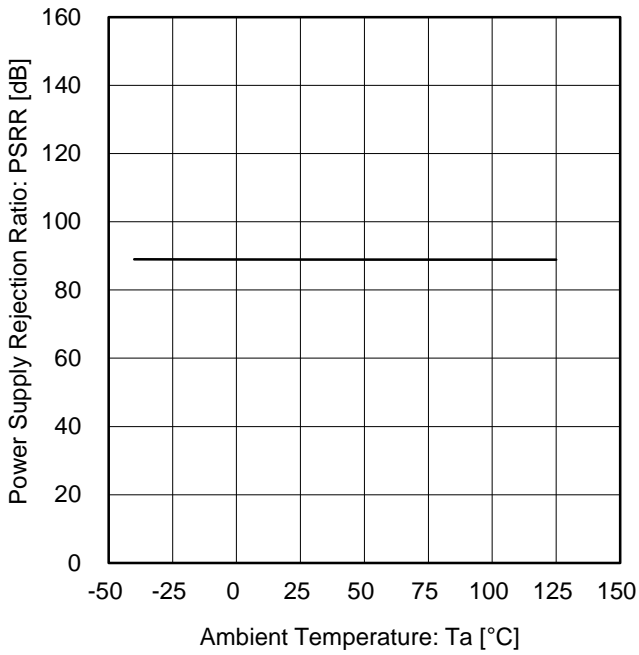

Figure 25. Power Supply Rejection Ratio vs Ambient Temperature

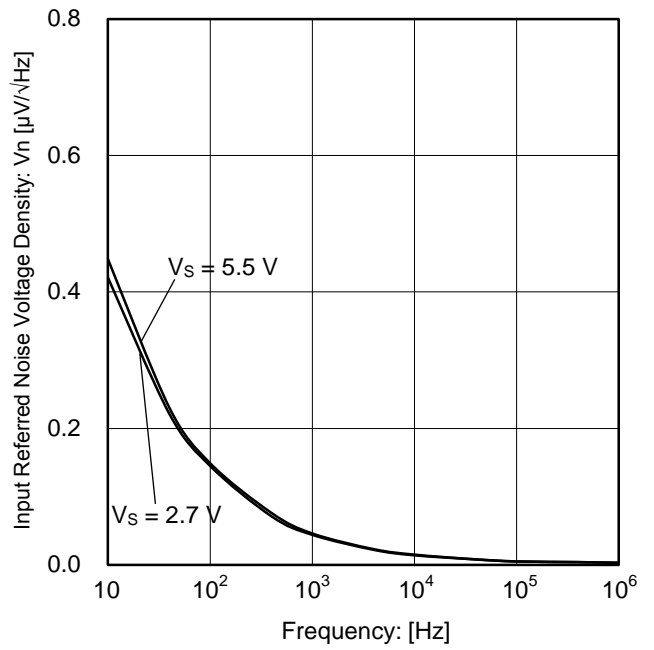

Figure 26. Input Referred Noise Voltage Density vs Frequency

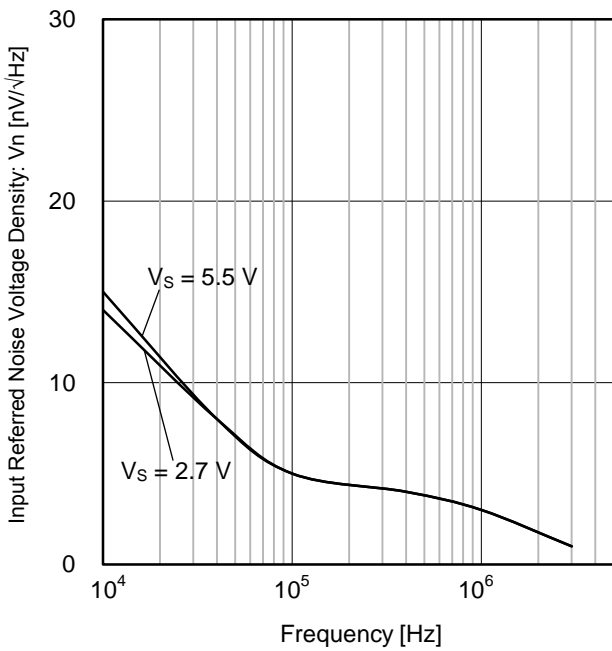

Figure 27. Input Referred Noise Voltage Density vs Frequency

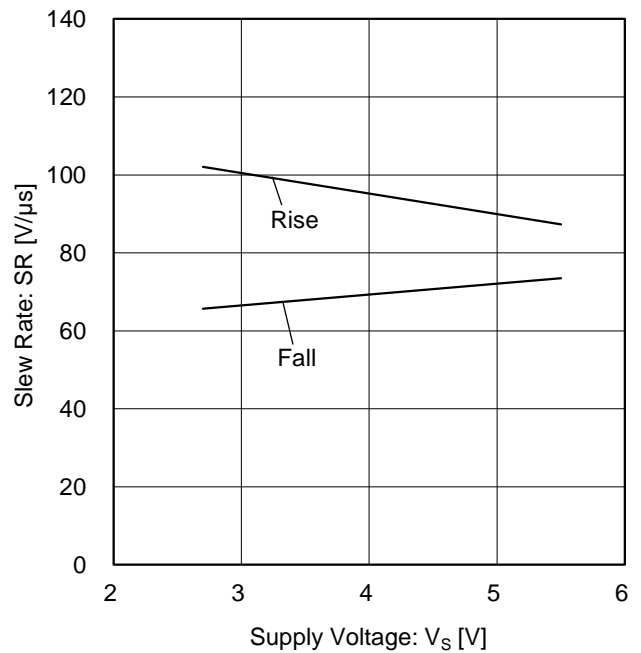

Figure 28. Slew Rate vs Supply Voltage

(Note) The above data are measurement value of typical sample; it is not guaranteed.

Typical Performance Curves – continued

(Reference data)  $V_{SS} = 0\text{ V}$

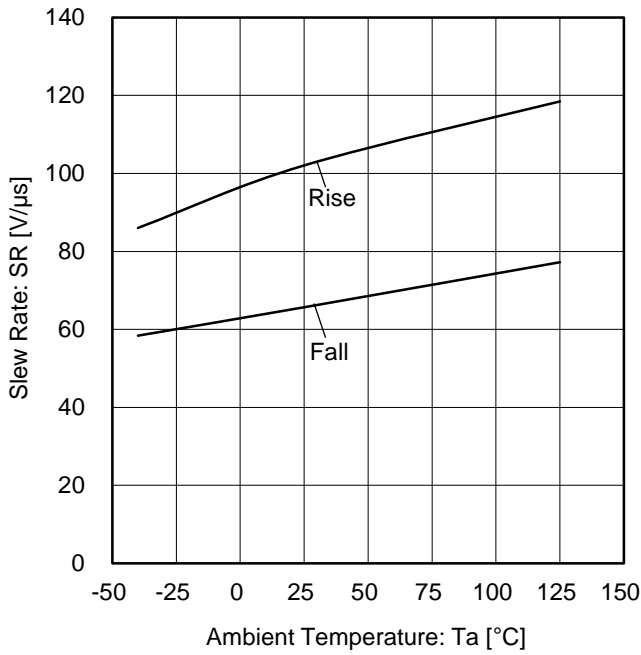

Figure 29. Slew Rate vs Ambient Temperature ( $V_S = 2.7\text{ V}$ )

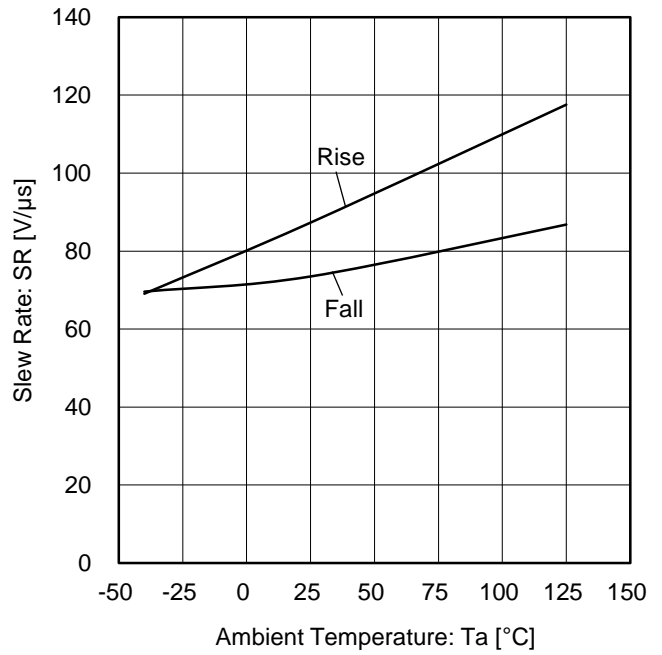

Figure 30. Slew Rate vs Ambient Temperature ( $V_S = 5.5\text{ V}$ )

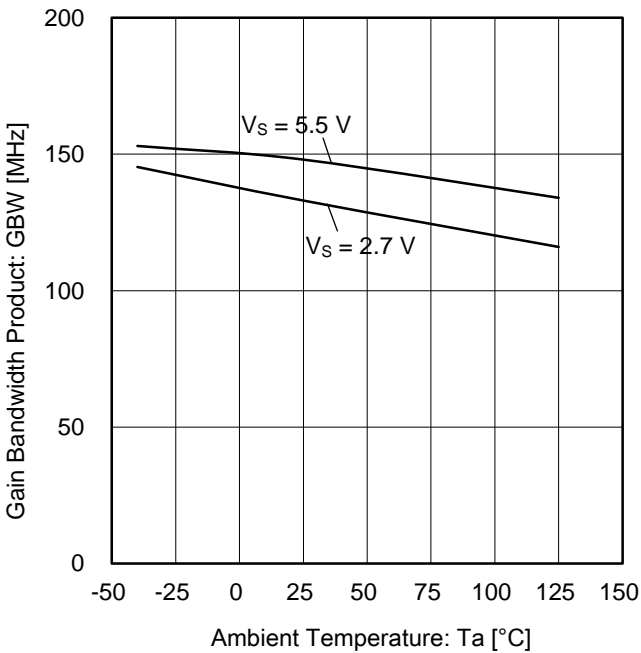

Figure 31. Gain Bandwidth Product vs Ambient Temperature ( $G = 20\text{ dB}$ )

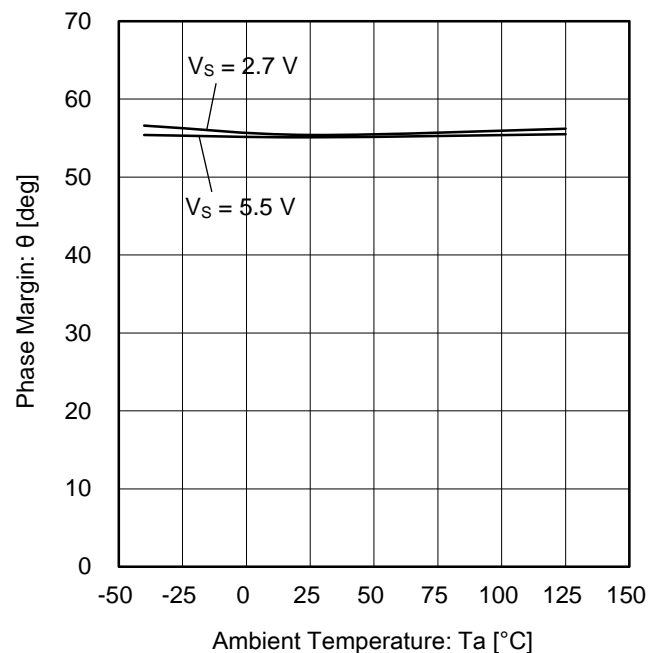

Figure 32. Phase Margin vs Ambient Temperature ( $G = 20\text{ dB}$ )

(Note) The above data are measurement value of typical sample; it is not guaranteed.

Typical Performance Curves – continued

(Reference data)  $V_{SS} = 0\text{ V}$

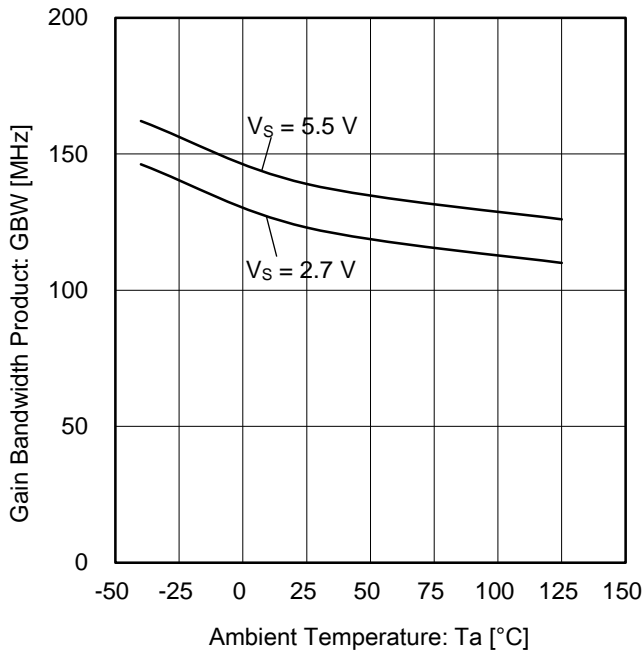

Figure 33. Gain Bandwidth Product vs Ambient Temperature ( $G = 20\text{ dB}$ )

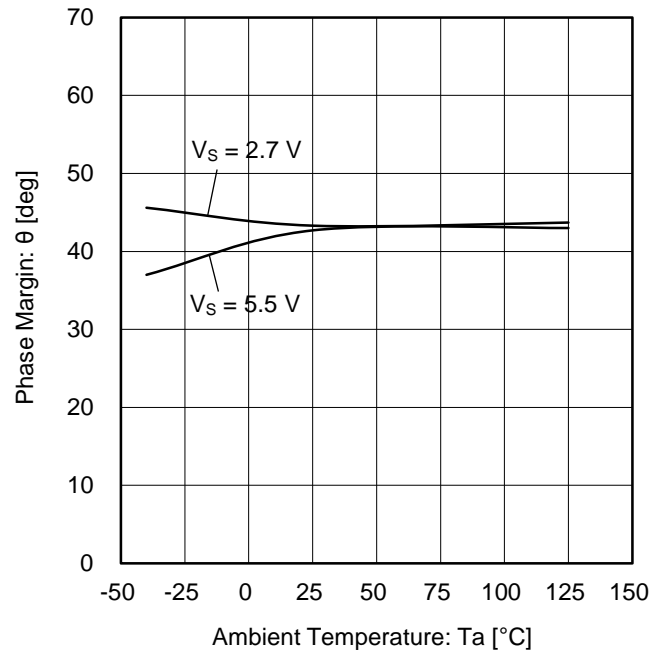

Figure 34. Phase Margin vs Ambient Temperature ( $G = 20\text{ dB}$ )

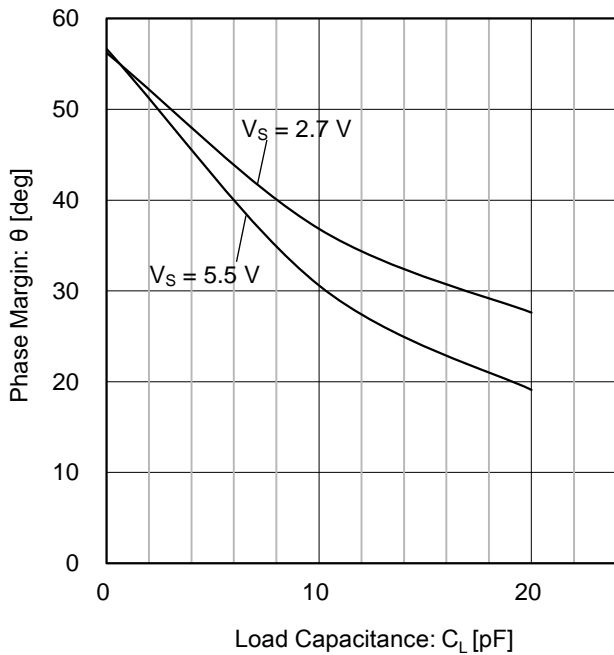

Figure 35. Phase Margin vs Load Capacitance ( $G = 20\text{ dB}$ )

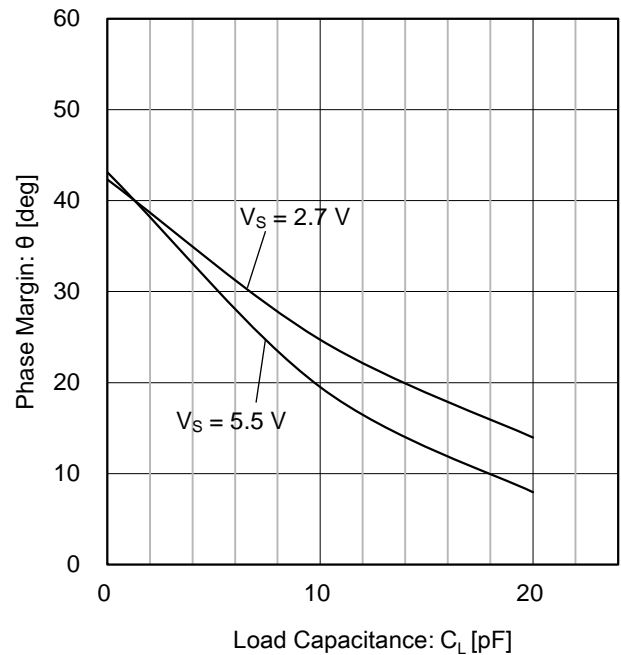

Figure 36. Phase Margin vs Load Capacitance ( $G = 20\text{ dB}$ )

(Note) The above data are measurement value of typical sample; it is not guaranteed.



Typical Performance Curves – continued

(Reference data)  $V_{SS} = 0\text{ V}$

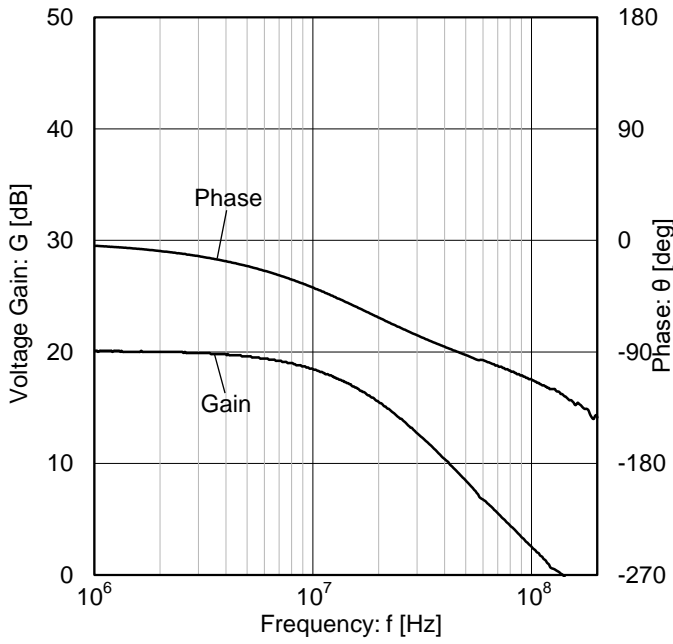

Figure 37. Voltage Gain, Phase vs Frequency  
( $G = 20\text{ dB}$ ,  $V_S = 2.7\text{ V}$ )

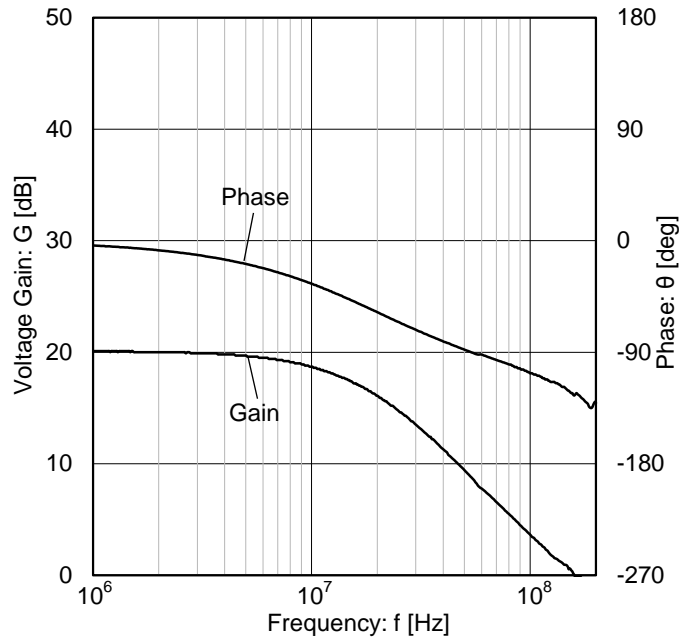

Figure 38. Voltage Gain, Phase vs Frequency  
( $G = 20\text{ dB}$ ,  $V_S = 5.5\text{ V}$ )

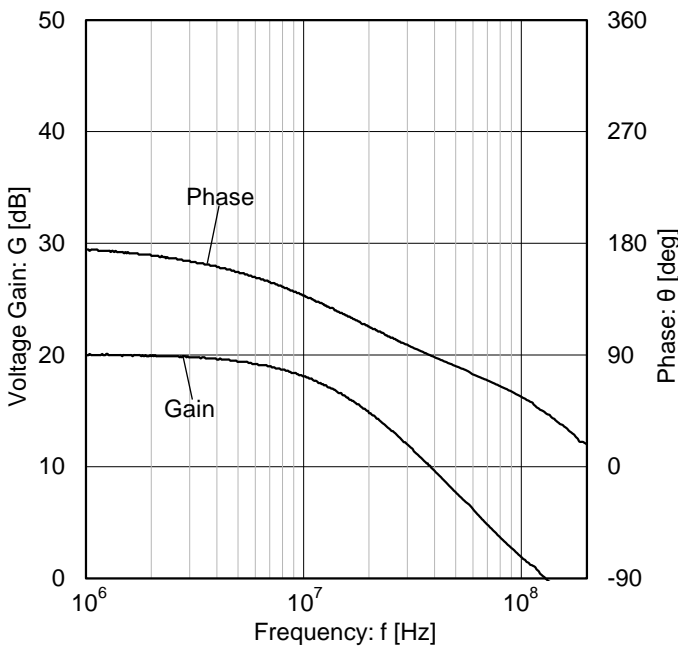

Figure 39. Voltage Gain, Phase vs Frequency  
( $G = 20\text{ dB}$ ,  $V_S = 2.7\text{ V}$ )

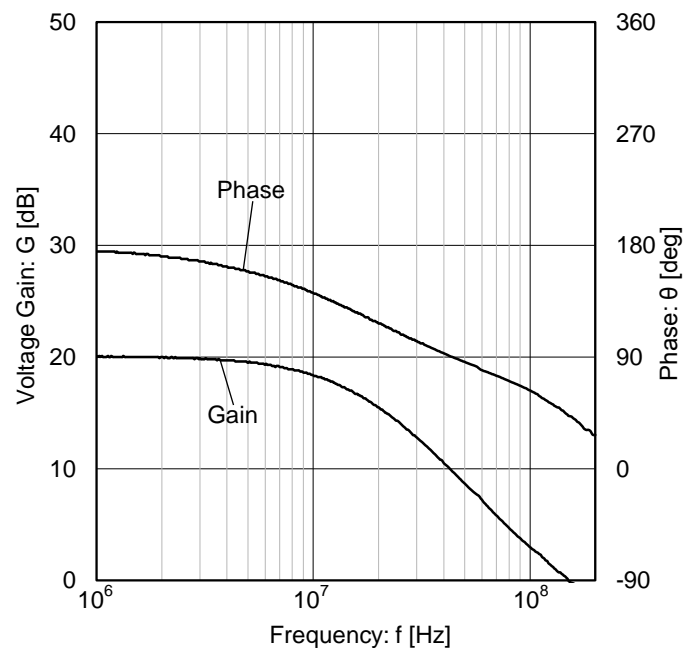

Figure 40. Voltage Gain, Phase vs Frequency  
( $G = 20\text{ dB}$ ,  $V_S = 5.5\text{ V}$ )

(Note) The above data are measurement value of typical sample; it is not guaranteed.

Typical Performance Curves – continued

(Reference data)  $V_{SS} = 0\text{ V}$

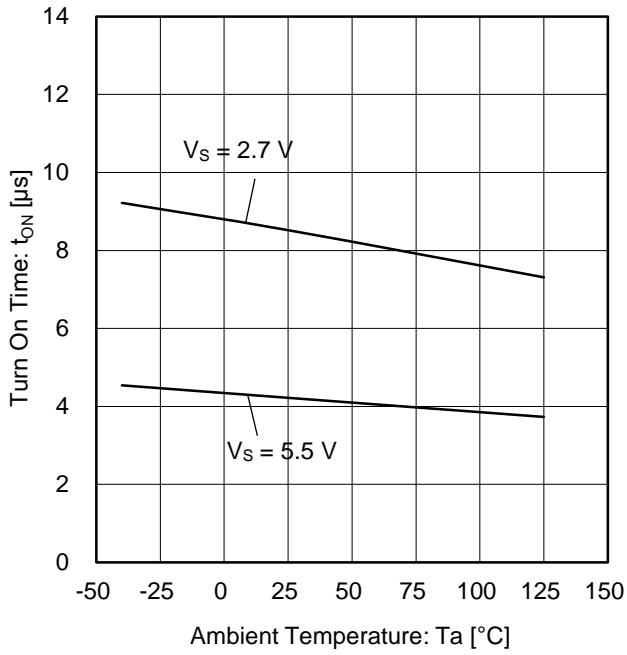

Figure 41. Turn On Time vs Ambient Temperature

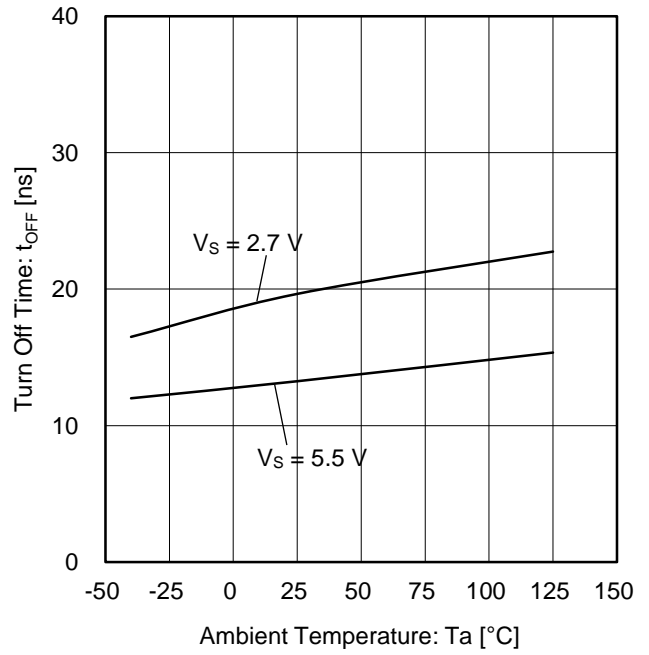

Figure 42. Turn Off Time vs Ambient Temperature

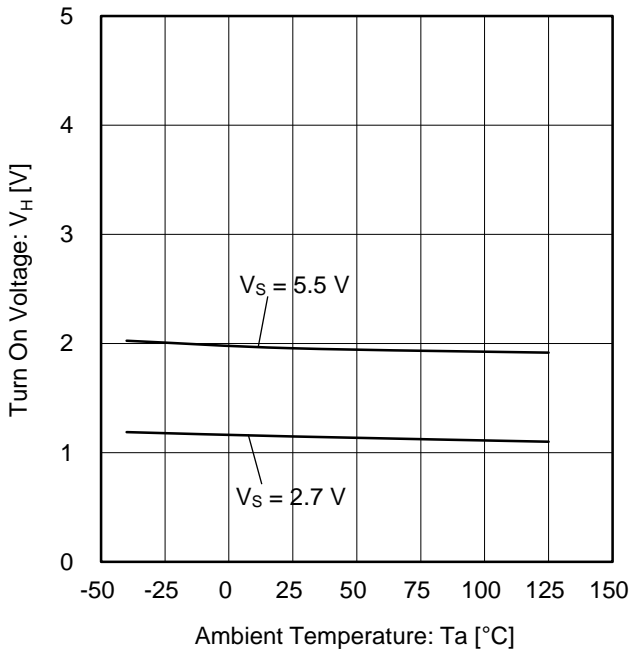

Figure 43. Turn On Voltage vs Ambient Temperature

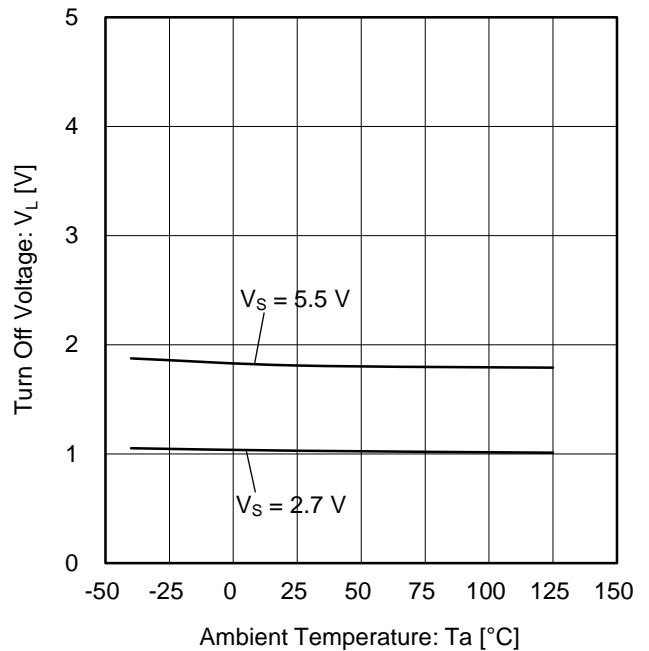

Figure 44. Turn Off Voltage vs Ambient Temperature

(Note) The above data are measurement value of typical sample; it is not guaranteed.

## Application Information

### 1. Input Voltage

Applying  $V_{SS}-0.3$  V to  $V_{DD}+0.3$  V to the input pins is possible without causing deterioration of the electrical characteristics or destruction. However, note that the circuit operates correctly only when the input voltage is within the common mode input voltage range of the electric characteristics.

### 2. Enable Pin

This IC may be affected by external noise because ENABLE pin is pulled up through high resistance to reduce current consumption. Connect an external pull up resistor as necessary.

### 3. Power Supply (Single / Dual)

The operational amplifier operates when the specified voltage is supplied between VDD and VSS. Therefore, single supply operational amplifiers can be used as dual supply operational amplifiers as well.

### 4. Latch Up

Do not set the voltage of the input/output pins to VDD or more and VSS or less because there is a possibility of latch up state peculiar to the CMOS device. Also, be careful not to apply abnormal noise and etc. to this IC.

### 5. Decoupling Capacitor

Insert the decoupling capacitor between VDD and VSS for stable operation of this IC. If the decoupling capacitor is not inserted, malfunction may occur due to the power supply noise.

### 6. Start-up the Supply Voltage

This IC has the input ESD protection diodes to between VDD and VSS. When the voltage is applied to the input pins without applying the power supply voltage, a current depending on the applied voltage flows in VDD or VSS through these diodes. This phenomenon causes breakdown or malfunction of the IC. Therefore, consider to protect the input pin and an order to supply the voltage.

This IC outputs high level voltage regardless of the state of input up to around 1 V which is the start-up voltage of the circuit. Pay attention to the order to supply the voltage to each pins and etc. because there is a possibility of set malfunction.

### 7. Output Capacitor

The elements inside the circuit may be damaged (thermal destruction) when VDD is shorted to the VSS and the electric charge is accumulated in the external capacitor connected to the output pin because the accumulated electric charge passes through the parasitic element or the protective element inside the circuit and is discharged to VDD.

If this IC is used in an application circuit which does not cause oscillation due to the output capacitive load (e.g., a voltage comparator not constituting a negative feedback circuit), the capacitor connected to the output pin should be 0.1  $\mu$ F or less in order to prevent the damage of this IC due to the electric charge accumulated in it.

Application Information – continued

8. Voltage Follower Circuit

The load resistance of 150 Ω or less should be connected to the output pin because oscillation may occur when this IC is used in the voltage follower circuits. Figure 45 and figure 46 show the effects of the load resistance on the voltage gains for the varying frequency.

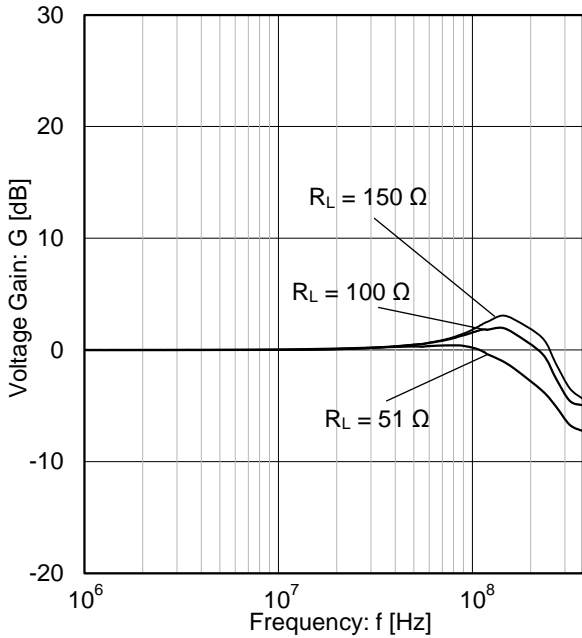

Figure 45. Voltage Gain vs Frequency  
(G = 0 dB,  $V_S = 2.7$  V)

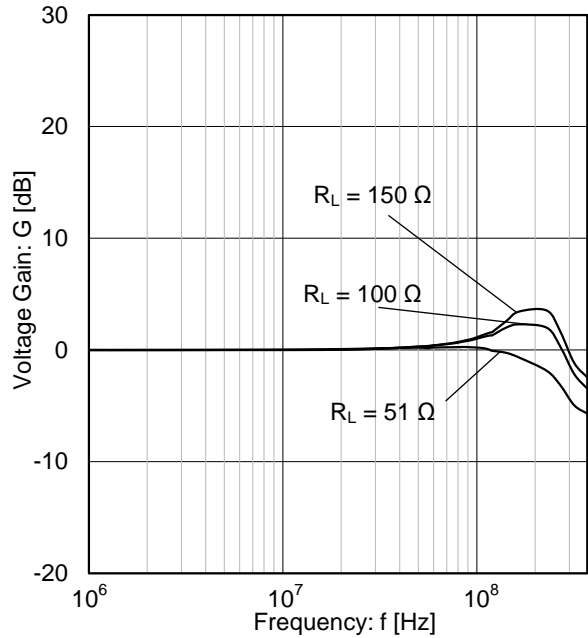

Figure 46. Voltage Gain vs Frequency  
(G = 0 dB,  $V_S = 5.5$  V)

9. Oscillation by Output Capacitor

Oscillation may occur when this IC is used to design an application circuit with the negative feedback circuit. Figure 47 and figure 48 show the effects of the capacitive load on the voltage gains for the varying frequency.

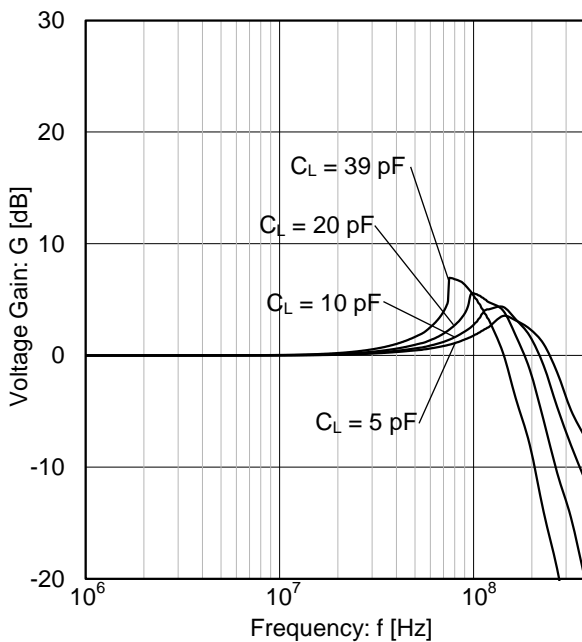

Figure 47. Voltage Gain vs Frequency  
(G = 0 dB,  $V_S = 2.7$  V,  $R_L = 100$  Ω)

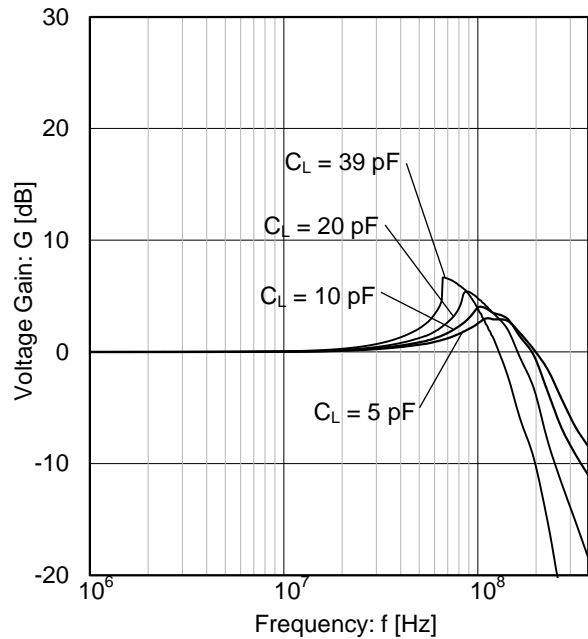

Figure 48. Voltage Gain vs Frequency  
(G = 0 dB,  $V_S = 5.5$  V,  $R_L = 100$  Ω)

Oscillation by Output Capacitor – continued

The frequency characteristics can be improved using the isolation resistor  $R_d$ , as shown in figure 50 to figure 51 and figure 53 to figure 54.

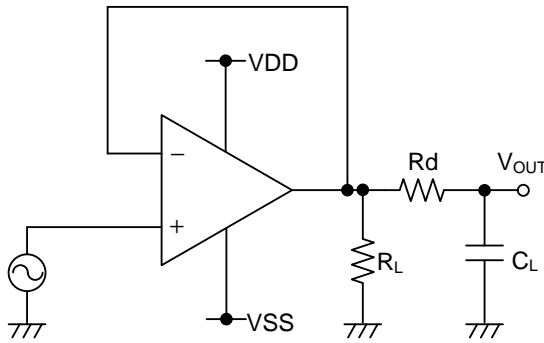

Figure 49. Improvement Circuit Example 1

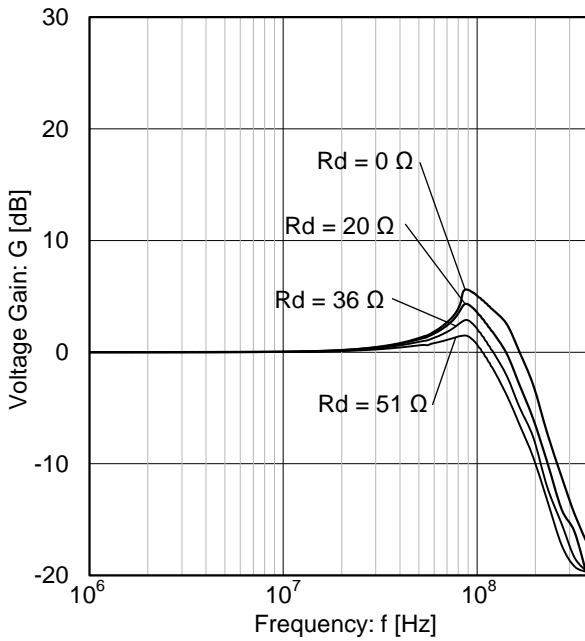

Figure 50. Voltage Gain vs Frequency  
( $G = 0$  dB,  $V_S = 2.7$  V,  $R_L = 100 \Omega$ ,  $C_L = 20$  pF)

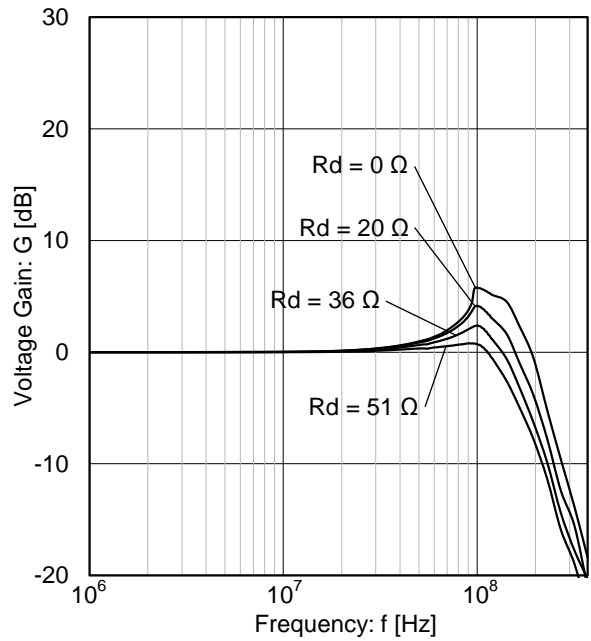

Figure 51. Voltage Gain vs Frequency  
( $G = 0$  dB,  $V_S = 5.5$  V,  $R_L = 100 \Omega$ ,  $C_L = 20$  pF)

Oscillation by Output Capacitor – continued

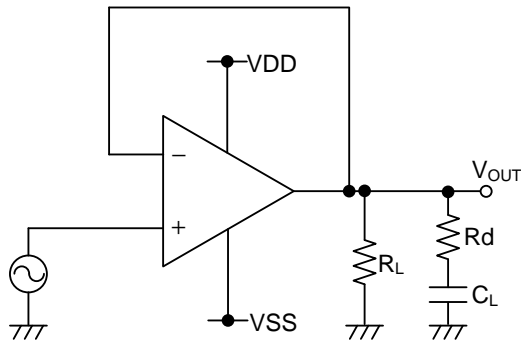

Figure 52. Improvement Circuit Example 2

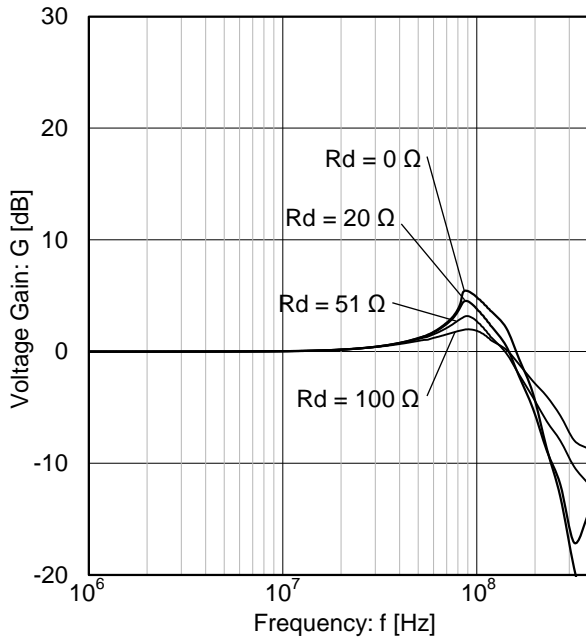

Figure 53. Voltage Gain vs Frequency  
( $G = 0$  dB,  $V_s = 2.7$  V,  $R_L = 100 \Omega$ ,  $C_L = 20$  pF)

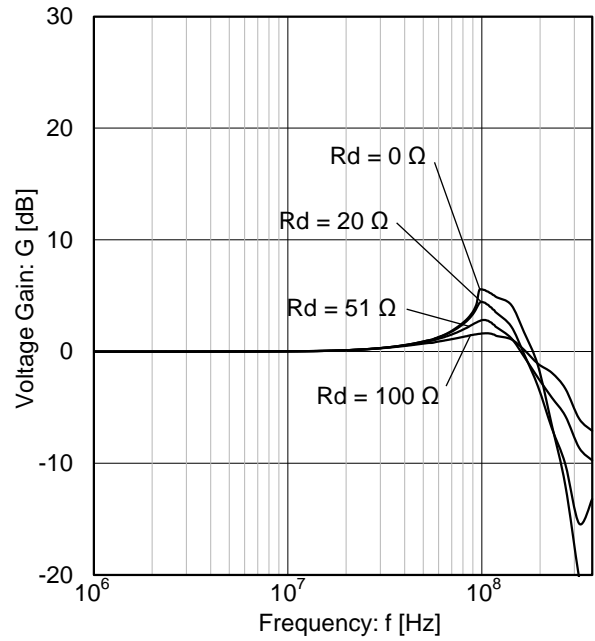

Figure 54. Voltage Gain vs Frequency  
( $G = 0$  dB,  $V_s = 5.5$  V,  $R_L = 100 \Omega$ ,  $C_L = 20$  pF)

## Application Examples

## ○Inverting Amplifier

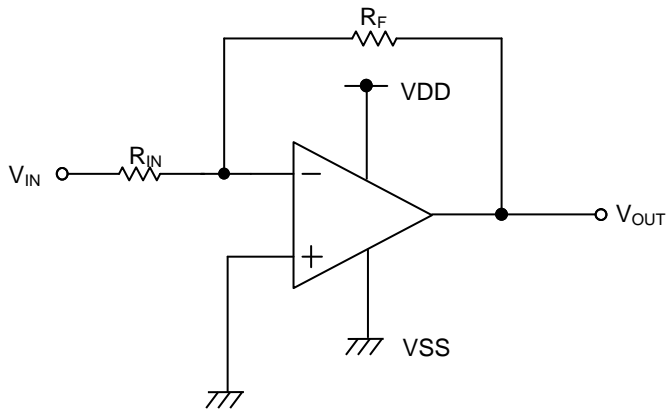

Figure 55. Inverting Amplifier Circuit

For inverting amplifier, input voltage ( $V_{IN}$ ) is amplified by a voltage gain and depends on the ratio of  $R_{IN}$  and  $R_F$ . The out-of-phase output voltage is shown in the next expression.

$$V_{OUT} = -\frac{R_F}{R_{IN}} V_{IN}$$

This circuit has input impedance equal to  $R_{IN}$ .

## ○Non-inverting Amplifier

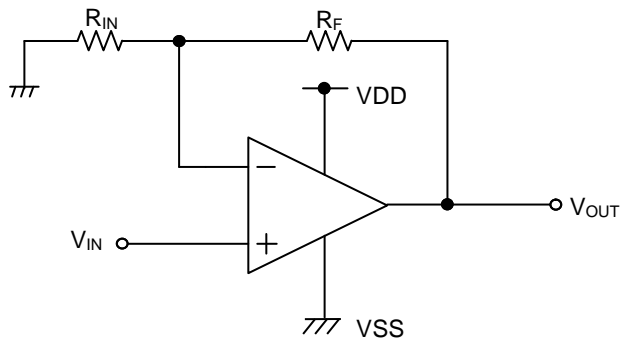

Figure 56. Non-inverting Amplifier Circuit

For non-inverting amplifier, input voltage ( $V_{IN}$ ) is amplified by a voltage gain, which depends on the ratio of  $R_{IN}$  and  $R_F$ . The output voltage ( $V_{OUT}$ ) is in-phase with the input voltage ( $V_{IN}$ ) and is shown in the next expression.

$$V_{OUT} = \left(1 + \frac{R_F}{R_{IN}}\right) V_{IN}$$

Effectively, this circuit has high input impedance since its input side is the same as that of the operational amplifier.

I/O Equivalence Circuits

Pin No.	Pin Name	Pin Description	Equivalence Circuit
1	OUT	Output	
3 4	+IN -IN	Input	
5	ENABLE	ENABLE Input	



## Operational Notes

### 1. Reverse Connection of Power Supply

Connecting the power supply in reverse polarity can damage the IC. Take precautions against reverse polarity when connecting the power supply, such as mounting an external diode between the power supply and the IC's power supply pins.

### 2. Power Supply Lines

Design the PCB layout pattern to provide low impedance supply lines. Furthermore, connect a capacitor to ground at all power supply pins. Consider the effect of temperature and aging on the capacitance value when using electrolytic capacitors.

### 3. Ground Voltage

Ensure that no pins are at a voltage below that of the ground pin at any time, even during transient condition.

### 4. Ground Wiring Pattern

When using both small-signal and large-current ground traces, the two ground traces should be routed separately but connected to a single ground at the reference point of the application board to avoid fluctuations in the small-signal ground caused by large currents. Also ensure that the ground traces of external components do not cause variations on the ground voltage. The ground lines must be as short and thick as possible to reduce line impedance.

### 5. Recommended Operating Conditions

The function and operation of the IC are guaranteed within the range specified by the recommended operating conditions. The characteristic values are guaranteed only under the conditions of each item specified by the electrical characteristics.

### 6. Inrush Current

When power is first supplied to the IC, it is possible that the internal logic may be unstable and inrush current may flow instantaneously due to the internal powering sequence and delays, especially if the IC has more than one power supply. Therefore, give special consideration to power coupling capacitance, power wiring, width of ground wiring, and routing of connections.

### 7. Testing on Application Boards

When testing the IC on an application board, connecting a capacitor directly to a low-impedance output pin may subject the IC to stress. Always discharge capacitors completely after each process or step. The IC's power supply should always be turned off completely before connecting or removing it from the test setup during the inspection process. To prevent damage from static discharge, ground the IC during assembly and use similar precautions during transport and storage.

### 8. Inter-pin Short and Mounting Errors

Ensure that the direction and position are correct when mounting the IC on the PCB. Incorrect mounting may result in damaging the IC. Avoid nearby pins being shorted to each other especially to ground, power supply and output pin. Inter-pin shorts could be due to many reasons such as metal particles, water droplets (in very humid environment) and unintentional solder bridge deposited in between pins during assembly to name a few.

### 9. Unused Input Pins

Input pins of an IC are often connected to the gate of a MOS transistor. The gate has extremely high impedance and extremely low capacitance. If left unconnected, the electric field from the outside can easily charge it. The small charge acquired in this way is enough to produce a significant effect on the conduction through the transistor and cause unexpected operation of the IC. So unless otherwise specified, unused input pins should be connected to the power supply or ground line.

Operational Notes – continued

10. Regarding the Input Pin of the IC

This monolithic IC contains P+ isolation and P substrate layers between adjacent elements in order to keep them isolated. P-N junctions are formed at the intersection of the P layers with the N layers of other elements, creating a parasitic diode or transistor. For example (refer to figure below):

- When  $GND > Pin A$  and  $GND > Pin B$ , the P-N junction operates as a parasitic diode.
- When  $GND > Pin B$ , the P-N junction operates as a parasitic transistor.

Parasitic diodes inevitably occur in the structure of the IC. The operation of parasitic diodes can result in mutual interference among circuits, operational faults, or physical damage. Therefore, conditions that cause these diodes to operate, such as applying a voltage lower than the GND voltage to an input pin (and thus to the P substrate) should be avoided.

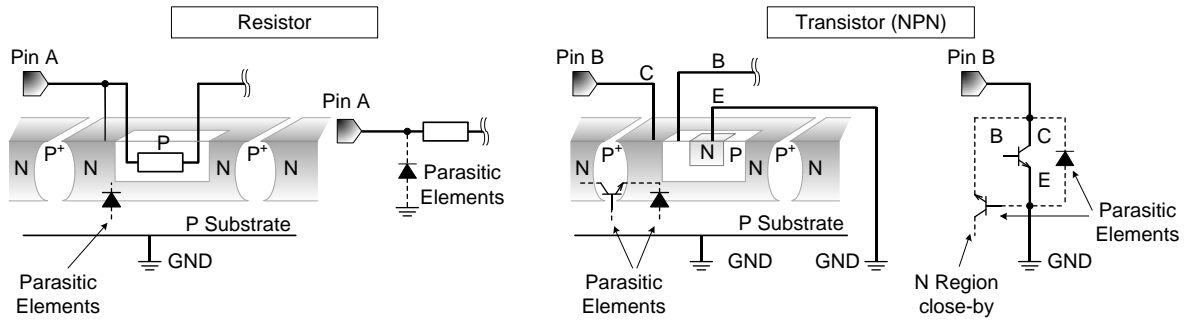
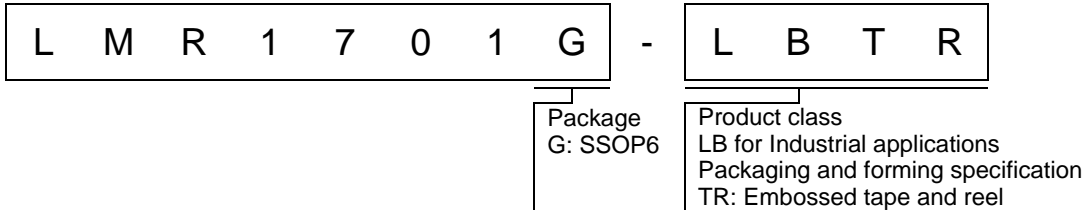

Figure 57. Example of monolithic IC structure

11. Ceramic Capacitor

When using a ceramic capacitor, determine a capacitance value considering the change of capacitance with temperature and the decrease in nominal capacitance due to DC bias and others.

Ordering Information



Marking Diagram

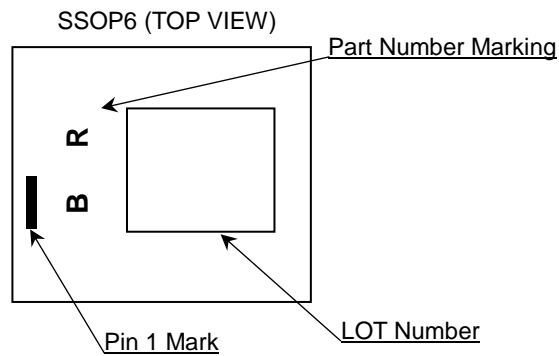

Physical Dimension and Packing Information

Package Name	SSOP6
--------------	-------

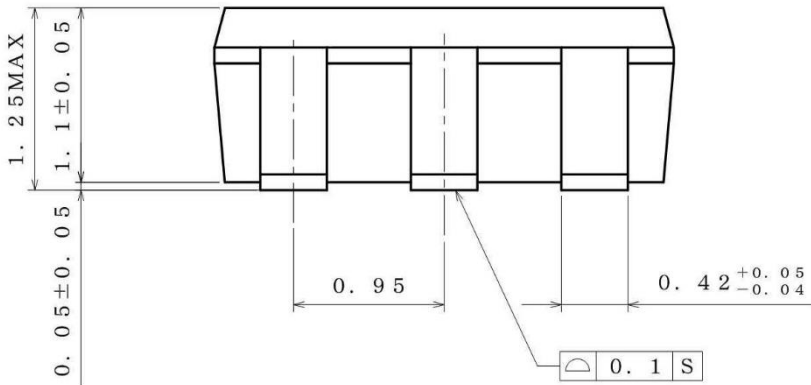
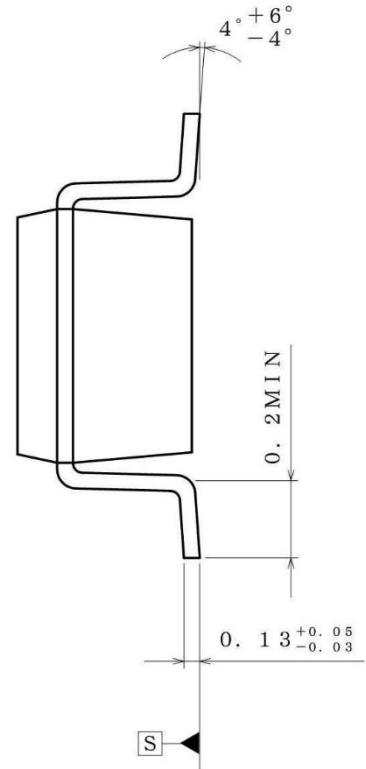
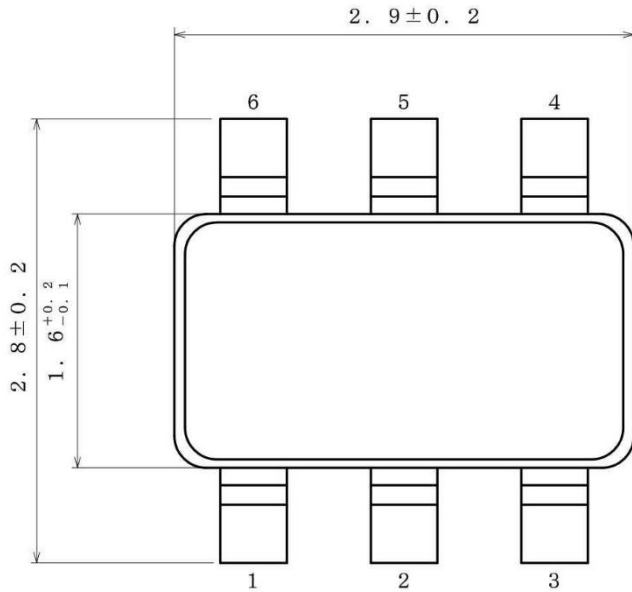

(UNIT : mm)

PKG : SSOP6

Drawing No. EX103-5001

< Tape and Reel Information >

Tape	Embossed carrier tape
Quantity	3000pcs
Direction of feed	TR ( The direction is the 1pin of product is at the upper right when you hold reel on the left hand and you pull out the tape on the right hand )

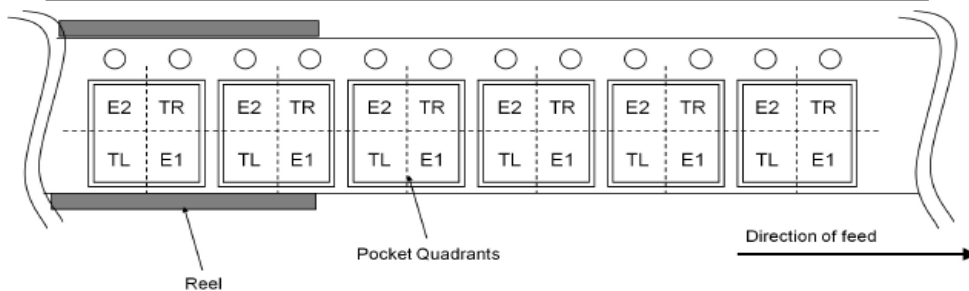

Revision History

Date	Revision	Changes
31.Jan.2020	001	New Release

# Notice

## Precaution on using ROHM Products

1. If you intend to use our Products in devices requiring extremely high reliability (such as medical equipment <sup>(Note 1)</sup>, aircraft/spacecraft, nuclear power controllers, etc.) and whose malfunction or failure may cause loss of human life, bodily injury or serious damage to property ("Specific Applications"), please consult with the ROHM sales representative in advance. Unless otherwise agreed in writing by ROHM in advance, ROHM shall not be in any way responsible or liable for any damages, expenses or losses incurred by you or third parties arising from the use of any ROHM's Products for Specific Applications.

(Note1) Medical Equipment Classification of the Specific Applications

JAPAN	USA	EU	CHINA
CLASS III	CLASS III	CLASS II b	CLASS III
CLASS IV		CLASS III	

2. ROHM designs and manufactures its Products subject to strict quality control system. However, semiconductor products can fail or malfunction at a certain rate. Please be sure to implement, at your own responsibilities, adequate safety measures including but not limited to fail-safe design against the physical injury, damage to any property, which a failure or malfunction of our Products may cause. The following are examples of safety measures:
  - [a] Installation of protection circuits or other protective devices to improve system safety
  - [b] Installation of redundant circuits to reduce the impact of single or multiple circuit failure
3. Our Products are not designed under any special or extraordinary environments or conditions, as exemplified below. Accordingly, ROHM shall not be in any way responsible or liable for any damages, expenses or losses arising from the use of any ROHM's Products under any special or extraordinary environments or conditions. If you intend to use our Products under any special or extraordinary environments or conditions (as exemplified below), your independent verification and confirmation of product performance, reliability, etc. prior to use, must be necessary:
  - [a] Use of our Products in any types of liquid, including water, oils, chemicals, and organic solvents
  - [b] Use of our Products outdoors or in places where the Products are exposed to direct sunlight or dust
  - [c] Use of our Products in places where the Products are exposed to sea wind or corrosive gases, including Cl<sub>2</sub>, H<sub>2</sub>S, NH<sub>3</sub>, SO<sub>2</sub>, and NO<sub>2</sub>
  - [d] Use of our Products in places where the Products are exposed to static electricity or electromagnetic waves
  - [e] Use of our Products in proximity to heat-producing components, plastic cords, or other flammable items
  - [f] Sealing or coating our Products with resin or other coating materials
  - [g] Use of our Products without cleaning residue of flux (Exclude cases where no-clean type fluxes is used. However, recommend sufficiently about the residue.); or Washing our Products by using water or water-soluble cleaning agents for cleaning residue after soldering
  - [h] Use of the Products in places subject to dew condensation
4. The Products are not subject to radiation-proof design.
5. Please verify and confirm characteristics of the final or mounted products in using the Products.
6. In particular, if a transient load (a large amount of load applied in a short period of time, such as pulse, is applied, confirmation of performance characteristics after on-board mounting is strongly recommended. Avoid applying power exceeding normal rated power; exceeding the power rating under steady-state loading condition may negatively affect product performance and reliability.
7. De-rate Power Dissipation depending on ambient temperature. When used in sealed area, confirm that it is the use in the range that does not exceed the maximum junction temperature.
8. Confirm that operation temperature is within the specified range described in the product specification.
9. ROHM shall not be in any way responsible or liable for failure induced under deviant condition from what is defined in this document.

## Precaution for Mounting / Circuit board design

1. When a highly active halogenous (chlorine, bromine, etc.) flux is used, the residue of flux may negatively affect product performance and reliability.
2. In principle, the reflow soldering method must be used on a surface-mount products, the flow soldering method must be used on a through hole mount products. If the flow soldering method is preferred on a surface-mount products, please consult with the ROHM representative in advance.

For details, please refer to ROHM Mounting specification

### Precautions Regarding Application Examples and External Circuits

1. If change is made to the constant of an external circuit, please allow a sufficient margin considering variations of the characteristics of the Products and external components, including transient characteristics, as well as static characteristics.
2. You agree that application notes, reference designs, and associated data and information contained in this document are presented only as guidance for Products use. Therefore, in case you use such information, you are solely responsible for it and you must exercise your own independent verification and judgment in the use of such information contained in this document. ROHM shall not be in any way responsible or liable for any damages, expenses or losses incurred by you or third parties arising from the use of such information.

### Precaution for Electrostatic

This Product is electrostatic sensitive product, which may be damaged due to electrostatic discharge. Please take proper caution in your manufacturing process and storage so that voltage exceeding the Products maximum rating will not be applied to Products. Please take special care under dry condition (e.g. Grounding of human body / equipment / solder iron, isolation from charged objects, setting of Ionizer, friction prevention and temperature / humidity control).

### Precaution for Storage / Transportation

1. Product performance and soldered connections may deteriorate if the Products are stored in the places where:
  - [a] the Products are exposed to sea winds or corrosive gases, including Cl<sub>2</sub>, H<sub>2</sub>S, NH<sub>3</sub>, SO<sub>2</sub>, and NO<sub>2</sub>
  - [b] the temperature or humidity exceeds those recommended by ROHM
  - [c] the Products are exposed to direct sunshine or condensation
  - [d] the Products are exposed to high Electrostatic
2. Even under ROHM recommended storage condition, solderability of products out of recommended storage time period may be degraded. It is strongly recommended to confirm solderability before using Products of which storage time is exceeding the recommended storage time period.
3. Store / transport cartons in the correct direction, which is indicated on a carton with a symbol. Otherwise bent leads may occur due to excessive stress applied when dropping of a carton.
4. Use Products within the specified time after opening a humidity barrier bag. Baking is required before using Products of which storage time is exceeding the recommended storage time period.

### Precaution for Product Label

A two-dimensional barcode printed on ROHM Products label is for ROHM's internal use only.

### Precaution for Disposition

When disposing Products please dispose them properly using an authorized industry waste company.

### Precaution for Foreign Exchange and Foreign Trade act

Since concerned goods might be fallen under listed items of export control prescribed by Foreign exchange and Foreign trade act, please consult with ROHM in case of export.

### Precaution Regarding Intellectual Property Rights

1. All information and data including but not limited to application example contained in this document is for reference only. ROHM does not warrant that foregoing information or data will not infringe any intellectual property rights or any other rights of any third party regarding such information or data.
2. ROHM shall not have any obligations where the claims, actions or demands arising from the combination of the Products with other articles such as components, circuits, systems or external equipment (including software).
3. No license, expressly or implied, is granted hereby under any intellectual property rights or other rights of ROHM or any third parties with respect to the Products or the information contained in this document. Provided, however, that ROHM will not assert its intellectual property rights or other rights against you or your customers to the extent necessary to manufacture or sell products containing the Products, subject to the terms and conditions herein.

### Other Precaution

1. This document may not be reprinted or reproduced, in whole or in part, without prior written consent of ROHM.
2. The Products may not be disassembled, converted, modified, reproduced or otherwise changed without prior written consent of ROHM.
3. In no event shall you use in any way whatsoever the Products and the related technical information contained in the Products or this document for any military purposes, including but not limited to, the development of mass-destruction weapons.
4. The proper names of companies or products described in this document are trademarks or registered trademarks of ROHM, its affiliated companies or third parties.

**General Precaution**

1. Before you use our Products, you are requested to carefully read this document and fully understand its contents. ROHM shall not be in any way responsible or liable for failure, malfunction or accident arising from the use of any ROHM's Products against warning, caution or note contained in this document.
2. All information contained in this document is current as of the issuing date and subject to change without any prior notice. Before purchasing or using ROHM's Products, please confirm the latest information with a ROHM sales representative.
3. The information contained in this document is provided on an "as is" basis and ROHM does not warrant that all information contained in this document is accurate and/or error-free. ROHM shall not be in any way responsible or liable for any damages, expenses or losses incurred by you or third parties resulting from inaccuracy or errors of or concerning such information.