

IFT208

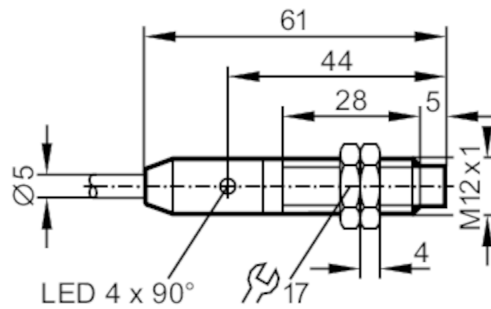

Inductive sensor

IFB3007-BPKG/M/V4A/6M/WH



Product characteristics

Electrical design		PNP
Output function		normally open
Sensing range	[mm]	7
Housing		threaded type
Dimensions	[mm]	M12 x 1 / L = 61

Application

Special feature		Increased sensing range
Application		Use in wet areas and in the food and beverage industry

Electrical data

Operating voltage	[V]	10...36 DC
Current consumption	[mA]	10; (24 V)
Protection class		II
Reverse polarity protection		yes

Outputs

Electrical design		PNP
Output function		normally open
Max. voltage drop switching output DC	[V]	2.5
Permanent current rating of switching output DC	[mA]	100
Switching frequency DC	[Hz]	800
Short-circuit protection		yes
Type of short-circuit protection		pulsed
Overload protection		yes

Detection zone

Sensing range	[mm]	7
Real sensing range Sr	[mm]	7 ± 10 %
Operating distance	[mm]	0...5.7
Increased sensing range		yes

IFT208



Inductive sensor

IFB3007-BPKG/M/V4A/6M/WH

Accuracy / deviations		
Correction factor	steel: 1 / stainless steel: 0.7 / brass: 0.5 / aluminium: 0.4 / copper: 0.3	
Hysteresis [% of Sr]	1...20	
Switch point drift [% of Sr]	-10...10	
Operating conditions		
Ambient temperature [°C]	0...100	
Protection	IP 68; IP 69K; ("COP")	
Tests / approvals		
EMC	EN 61000-4-2 ESD	4 kV CD / 8 kV AD
	EN 61000-4-3 HF radiated	10 V/m
	EN 61000-4-4 Burst	2 kV
	EN 61000-4-6 HF conducted	10 V
	EN 55011	class B
MTTF [years]	2006	
UL approval	Ta	0...40 °C
	Enclosure type	Type 1
	voltage supply	Limited Voltage/Current
	File number UL	E174191
Mechanical data		
Weight [g]	264.5	
Housing	threaded type	
Mounting	non-flush mountable	
Dimensions [mm]	M12 x 1 / L = 61	
Thread designation	M12 x 1	
Materials	stainless steel (1.4404 / 316L); sensing face: PEEK	
Displays / operating elements		
Display	switching status	4 x 90° LED, yellow
Accessories		
Accessories (supplied)	lock nuts: 2	
Remarks		
Pack quantity	1 pcs.	

IFT208



Inductive sensor

IFB3007-BPKG/M/V4A/6M/WH

Electrical connection

Cable: 6 m, PVC; 3 x 0.34 mm²

Connection



Core colours

BK	black
BN	brown
BU	blue