

M12 FEMALE 90° SHIELDED

PUR 4X0.34 shielded GRAY, UL/CSA, drag ch 10m

M12
Female 90°
4-pole, shielded

Plastic housings with good resistance against chemicals and oils. The resistance to aggressive media should be individually tested for your application. Further details on request. Further cable lengths on request.

[Link to Product](#)

Illustration

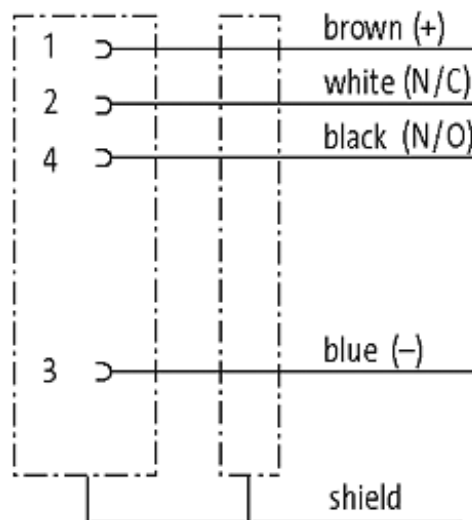

Female

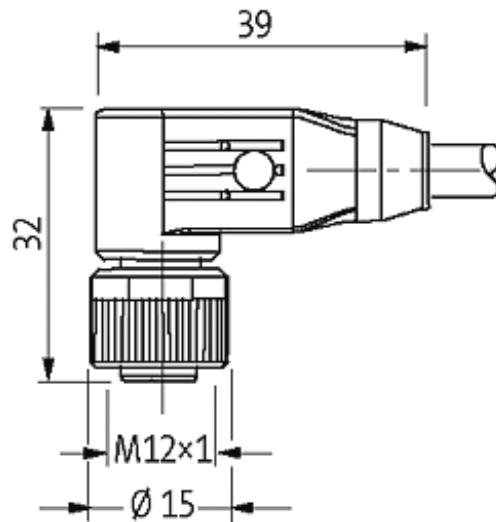

Product may differ from Image