

Grub Screws with Star Grip · plastic

24750.0122



Product Description

Material

Cap

- Thermoplastic PA, orange similar to RAL 2004

Handle

- Thermoplastic PA 6, black similar to RAL 9005

Screw

- stainless steel

More information

Notes

Special types, e.g. differing threads or thread lengths, on request.

Drawing

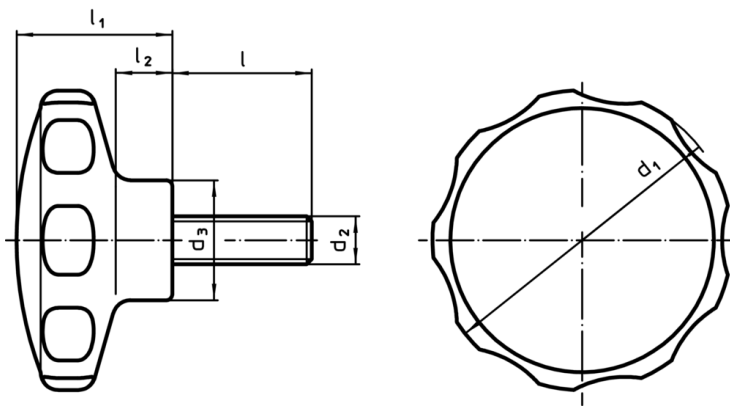

Order information

Dimensions						min.	max.	[g]	Art. No.
d ₁	d ₂	l	d ₃	l ₁	l ₂				
orange									
30	M4	18	14	19	7	-30	80	6.9	24750.0122

Application example



Compliance

RoHS compliant

Compliant according to Directive 2011/65/EU and Directive 2015/863

Does not contain SVHC substances

No SVHC substances with more than 0.1% w/w contained - SVHC list [REACH] as of 10.06.2022

Does not contain Proposition 65 substances

No Proposition 65 substances included
<https://www.P65Warnings.ca.gov/>

Free from Conflict Minerals

This product does not contain any substances designated as "conflict minerals" such as tantalum, tin, gold or tungsten from the Democratic Republic of Congo or adjacent countries.