

1591XXA Enclosure

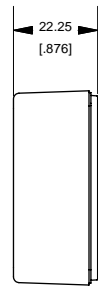

SIDE VIEW OF BOX

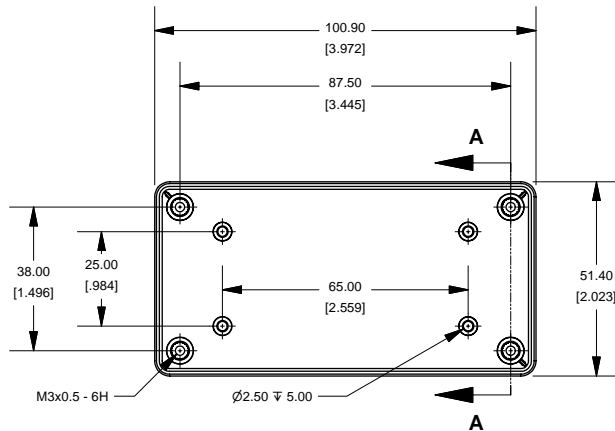

TOP VIEW OF BOX

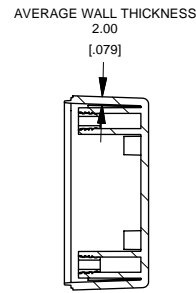

SECTION A-A

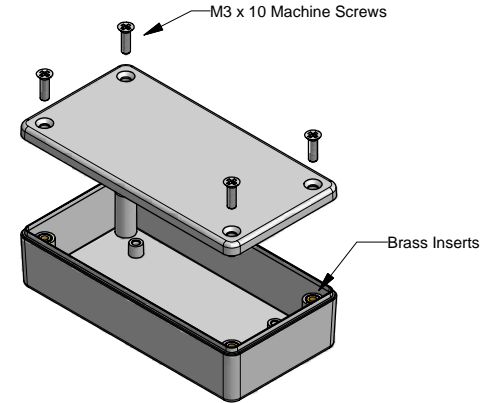

EXPLODED VIEW OF ENCLOSURE

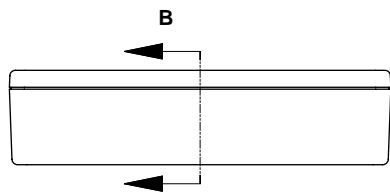

SIDE VIEW OF ENCLSURE

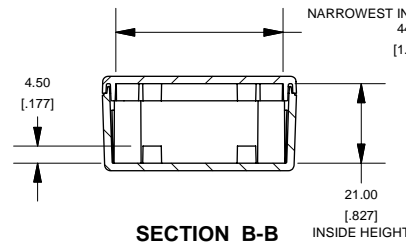

SECTION B-B

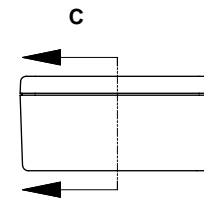

END VIEW OF ENCLOSURE

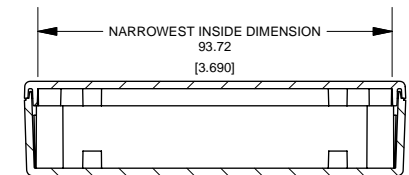

SECTION C-C

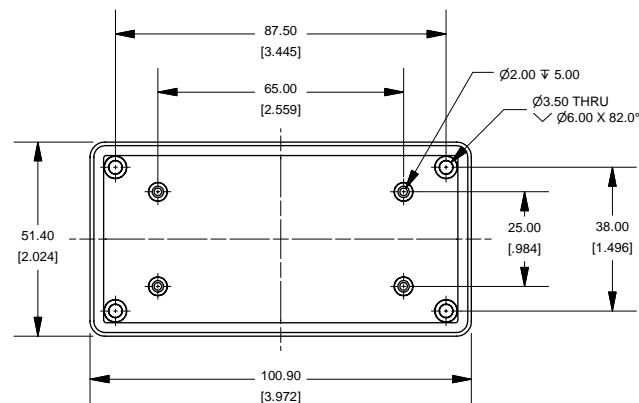

BOTTOM VIEW OF LID

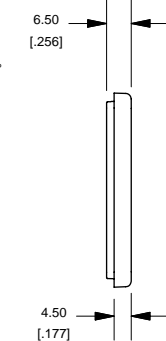

SIDE VIEW OF LID

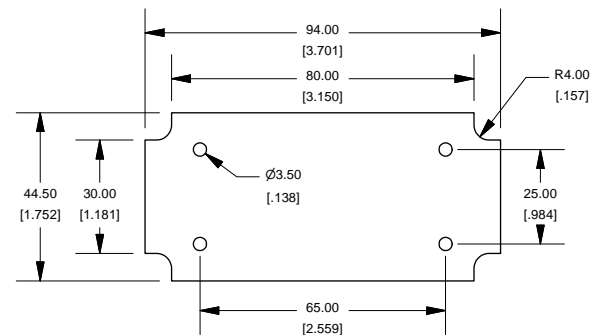

Max Size PCB. Fits in Box or in Lid.
Not supplied with Enclosure

Note:

Enclosures can be Factory Modified (Milling, Drilling, Printing etc.)
Solid models of this enclosure available in STEP or IGES.
Contact Factory mjm@hammondmfg.com

NOTE	
Enclosure molded from FRABS UL 94-V0 Plastic. Other materials / Colours Available Consult Factory	
1591XXA	
1591XXA Enclosure	
Black Enclosure - RAL 7011	1591XXABK
Gray Enclosure - RAL 7035	1591XXAGY
ACCESSORIES	
For Flame Retardant ABS (UL94-V0)	
Black Enclosure Cover Screws (Pkg 100)	1591MS100BK
Gray Enclosure Cover Screws (Pkg 100)	1591MS100
P.C. Board Screws (All Boxes)	
P.C. Board Screws [#4 x 1/4" self-tapping (6.4mm)]	1593ATS50 (Pkg 50) 1593ATS100 (Pkg 100)

