

M12 male 90° / M12 female 90° shielded Cube67

PUR 0.5+0.25 shielded gn UL/CSA+drag ch. 6m

Cube67, 6-pole

Hybrid cable for communication and supply

Male 90° to female 90°

M12 - M12

6-pole used, shielded

Plastic housings with good resistance against chemicals and oils. The resistance to aggressive media should be individually tested for your application. Further details on request. Further cable lengths on request.

[Link to Product](#)

Illustration

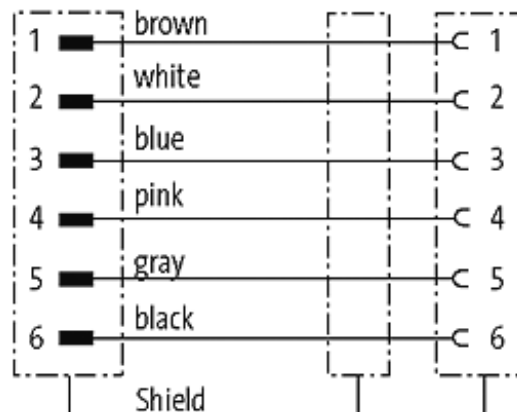
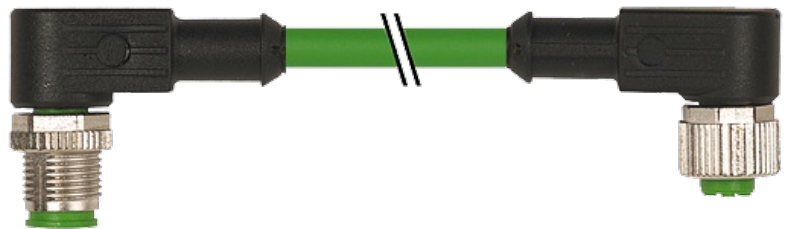

Male

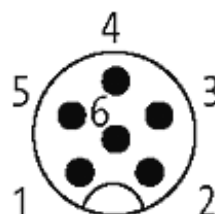

Female

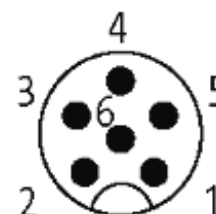

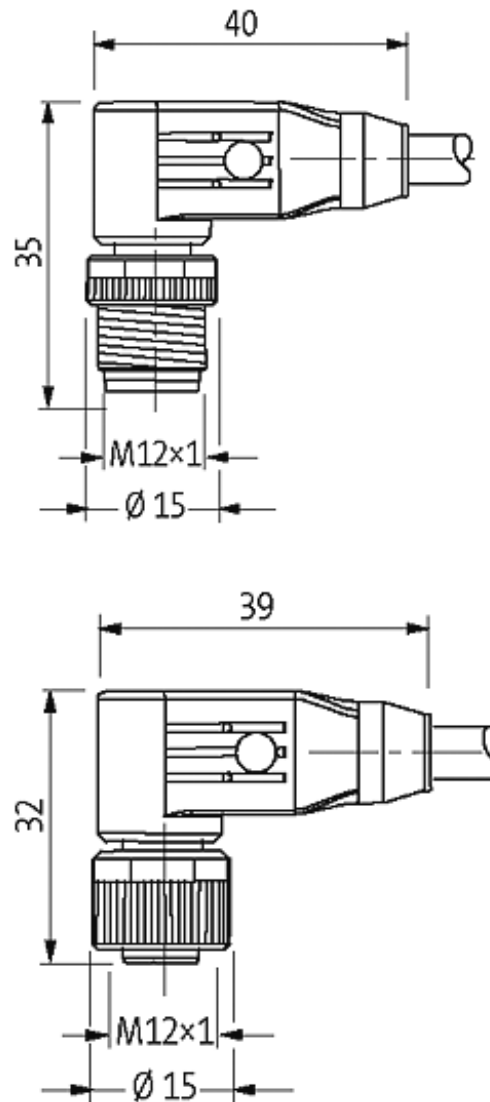

Product may differ from Image

Approvals



More Info

Cube67

Form

46061

Technical Data

| | |
|-------------------------------|---|
| Operating voltage | max. 30 V AC/DC |
| Operating current per contact | max. 4 A |
| Locking of ports | Screw thread M12 × 1 mm (recommended torque 0.6 Nm) self-securing |

Protection IP67 inserted and tightened (EN 60529)

Cables

| | |
|-----------------------------|--------------------------------|
| Cable number | 802 |
| No./diameter of wires | 4×0.5 + 2×0.25 mm ² |
| Wire isolation | PP (br, bl, bk, wh), (gr, pk) |
| C-track properties | 5 Mio. |
| Torsion | ± 180°/m |
| Jacket Color | green |
| Shore hardness outer jacket | 90 ± 5A |
| Material (jacket) | PUR (UL/CSA) |
| Outer diameter | approx. 7.9 mm |
| Bend radius (fixed) | 5 × outer Ø |
| Bend radius (moving) | 10 × outer Ø |
| Temperature range (fixed) | -50...+80 °C |
| Temperature range (mobile) | -40...+80 °C |
| Shielded | yes |

Commercial data

| | |
|------------------------|----------|
| country of origin | DE |
| customs tariff number | 85444290 |
| minimum order quantity | 1 |