



Produktname | *Product name*: Lithium 4
 Artikelnummer | *Part Number*: 1001-0122
 Anfragenummer | *Inquiry Number*: 810583
 Ersteller / Datum | *Creator / Date*: KA / 2021-02-11

Version	Änderung / Change	Datum / Date	Name
VA	--- (Vorläufig Preliminary)	2021-02-11	KA

Template name: ANSMANN xxxx-xxxx_0DA, Template version: V27



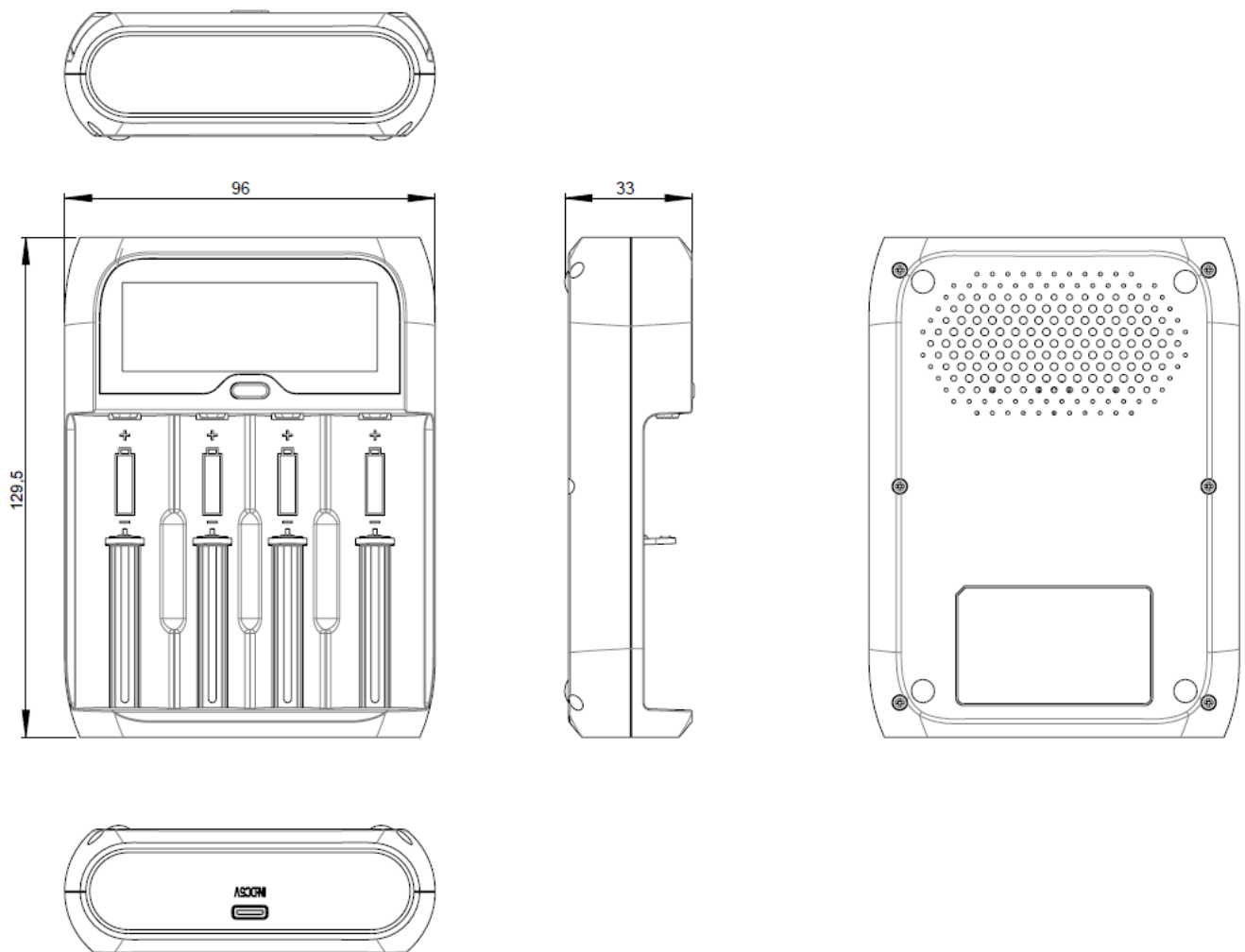





Zeichnung des Ladegerätes / Drawing of the charger

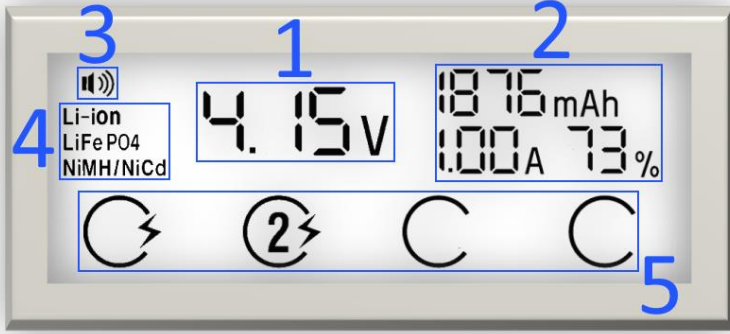

Allowable deviation / general tolerances DIN ISO 2768-c

Technische Daten des Ladegerätes / Technical data of the charger:

DC Eingangsbuchse:	USB C Buchse	<i>DC input socket:</i>	<i>USB C socket</i>
DC Eingangsspannung:	5 V ($\pm 5\%$)	<i>DC input voltage:</i>	<i>5 V ($\pm 5\%$)</i>
DC Eingangsstrom:	max. 2.4 A	<i>DC input current:</i>	<i>max. 2.4 mA</i>
Anzahl der Ladeschächte:	4	<i>Number of charging slots:</i>	<i>4</i>
Ladbare Akku-Chemie:	NiMH / Li-Ion / LiFePO4	<i>Chargeable battery chemistry:</i>	<i>NiMH / Li-Ion / LiFePO4</i>
Ladbare Akku-Größen:	NiMH: AA, AAA, C Li-Ion/LiFePO4: from 10340 to 26650	<i>Chargeable battery size:</i>	<i>NiMH: AA, AAA, C Li-Ion/LiFePO4: from 10340 to 26650</i>
Max. ladbare Kapazität:	NiMH: 8000 mAh Li-Ion/LiFePO4: 12000 mAh	<i>Max. charging capacity:</i>	<i>NiMH: 8000 mAh Li-Ion/LiFePO4: 12000 mAh</i>
Ladeüberwachung / Ladeschlusserkennung:	NiMH: -dV, 0dV, Temperatur, timer Li-Ion/LiFePO4: CCCV, Temperatur, timer	<i>Charge control / Charge end detection:</i>	<i>NiMH: -dV, 0dV, Temperature, timer Li-Ion/LiFePO4: CCCV, Temperature, timer</i>
Nominale Ladespannung:	NiMH: 1,48V Li-Ion: 3,6V/3,7V LiFePO4: 3,2V	<i>nominal charge voltage:</i>	<i>NiMH: 1,48V Li-Ion: 3,6V/3,7V LiFePO4: 3,2V</i>
Ladestrom ($\pm 10\%$):	NiMH: 500mA Li-Ion/LiFePO4: Schacht 1 und 4: 1x2000mA / 2x1000mA Alle Schächte: 3x650mA / 4x500mA	<i>Charge current ($\pm 10\%$):</i>	<i>NiMH: 500mA Li-Ion/LiFePO4: Slot 1 and 4: 1x2000mA / 2x1000mA All Slots: 3x650mA / 4x500mA</i>
Erhaltungsladestrom:	NiMH: 3mA ($\pm 20\%$)	<i>Trickle charge current:</i>	<i>NiMH: 3mA ($\pm 20\%$)</i>
Temperatur Abschaltung:	Max. 60°C ($\pm 5^\circ\text{C}$)	<i>Temperature cut off:</i>	<i>Max. 60°C ($\pm 5^\circ\text{C}$)</i>
Sicherheitstimer:	16h ($\pm 10\%$)	<i>Security timer:</i>	<i>16h ($\pm 10\%$)</i>
Kurzschlusserkennung:	Ja	<i>Short circuit detection:</i>	<i>Yes</i>
0V Ladefunktion:	Ja	<i>0V charge function:</i>	<i>Yes</i>
Alkaline Erkennung:	Ja	<i>Alkaline detection:</i>	<i>Yes</i>
Akku-Defekt-Erkennung:	Ja	<i>Battery defect detection:</i>	<i>Yes</i>
Verpolschutz:	Ja (Elektronisch)	<i>Wrong polarity protection:</i>	<i>Yes (Electrical)</i>
Bedienung (Taster):	1x kurz drücken: Akku auswählen Taster Doppelklick: Akustisches Signal ein-/ausschalten 1x lang drücken: LiFePO4 Modus auswählen	<i>Operation (push button):</i>	<i>Press 1x briefly: Select battery Button double click: Acoustic signal switch on/off 1x long press: LiFePO4 mode select</i>

LCD Anzeige:		LCD indicator:	
			
1:	Akku Spannung	1:	Battery voltage
2:	Eingeladene Kapazität, Ladestrom, Ladezustand in %	2:	Charged capacity Charge current Charge state in %
3:	Zeigt, ob die akustische Rückmeldung aktiviert ist	3:	Shows whether the acoustic feedback is activated
4:	Anzeige der Akku- Chemie	4:	Shows the battery chemistry
5:	Ladeschacht Status Anzeige	5:	Charge slot status indication
Akku ist selektiert:	Nummer des Schachtes erscheint im Symbol	Battery is selected:	Number from the charge slot is shown in symbol
Kein Akku eingelegt:		No battery is inserted:	
Akku wird geladen:		Charge the battery:	
Akku ist vollgeladen:		Battery is full:	
Akku ist defekt:		Battery is defective:	
Anzeige Dimm-Funktion:	30s nach letzter Bedienung	Display Dimm function:	30s after last handling
Schutzart:	IP20	Ingress Protection Marking:	IP20
Gehäusematerial:	Kunststoff	Housing material:	Plastic
Gehäusetyt:	Steckergehäuse	Housing type:	Plug-in case
Betriebstemperatur:	0°C...25°C	Operating temperature:	0°C...25°C
Approbationen:	CE	Approvals:	CE
Gewicht:	165 g (Lader) 180 g (Lader + Zubehör)	Weight:	165 g (charger) 180 g (charger + accessories)
Lagertemperatur:	-20°C...60°C	Storage temperature:	-20°C...60°C
Lieferumfang:	- Ladegerät - USB Typ-C Kabel Mehrsprachige Bedienungsanleitung	Shipment:	- Charger - USB type-C cable Multilingual operating instruction
Verpackung:	- Farbige Faltschachtel	Package:	- Coloured folding box