

E40259

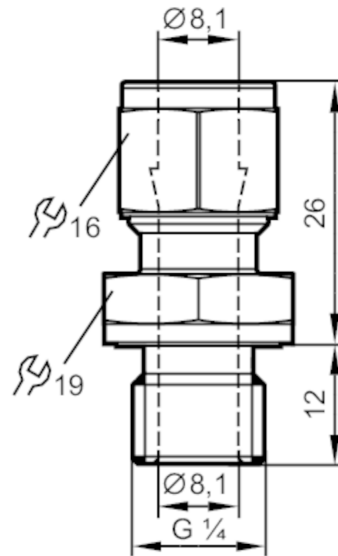

Progressive ring fitting

COMPRESSION FITTING G1/4



Application	
Pressure rating	[bar] 50
Mechanical data	
Weight	[g] 50
Materials	stainless steel (1.4404 / 316L); Gasket: FKM
Sensor connection	Ø 8 mm
Process connection	G 1/4
Accessories	
Accessories (supplied)	Gasket
Remarks	
Pack quantity	1 pcs.