



### Model Number

#### V1-W-N-2M-PUR

Female cordset, M12, 2-pin, NAMUR, PUR cable

### Features

- Suitable for NAMUR technology
- Blue body and sheathing
- Knurled nut suitable for tool assembly
- Immunity to vibration, with mechanical latching
- Gold plated contacts
- Protection degree IP67 / IP68 / IP69K

### Dimensions

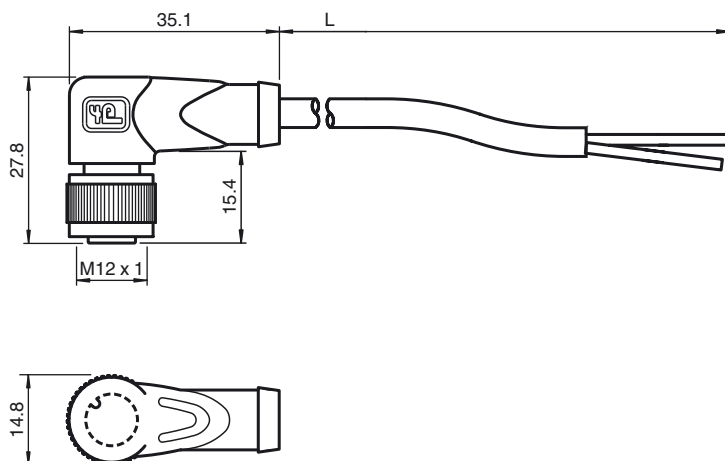

### Technical data

#### General specifications

Number of pins	2
Connection 1	socket
Construction type 1	right angle
Threading 1	M12
Connection 2	cable end
UL File Number	E231213

#### Electrical specifications

Operating voltage	$U_B$	max. 250 V AC/DC
Operating current		max. 4 A
Contact resistance		< 10 mΩ
Inductance		0.6 mH / km
Capacitance		82 nF / km

#### Ambient conditions

Ambient temperature	Body: -40 ... 90 °C (-40 ... 194 °F) cable, fixed: -40 ... 80 °C (-40 ... 176 °F) cable, flexing: -20 ... 80 °C (-4 ... 176 °F)
Pollution Degree	3

#### Mechanical specifications

Contact elements	spring-loaded contact socket
Pin diameter	1 mm
Protection degree	IP67 / IP68 / IP69k
Material	
Contacts	CuSn / Au
Contact surface	Au
Body	TPU, blue
Cable	PUR
Slotted nut	Diecast zinc
Core insulation	PVC
Cable	extra-fine wire, flexible
Sheath diameter	Ø 4.8 mm
Bending radius	> 15 x cable diameter, induced > 10 x cable diameter, fixed
Color	blue
Cores	2 x 0.34 mm <sup>2</sup>
Conductor construction	42 x 0.1 mm Ø
Length	L 2 m
Flammability	
Contact material	94 HB
Housing	94 V-2

#### Compliance with standards and directives

Standard conformity	
Protection degree	EN 60529:2000

### Electrical connection

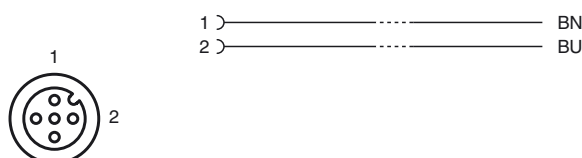



Standards	IEC 61076-2-101:2008
Flammability	Grip: UL 94

Release date: 2014-01-08 13:09 Date of issue: 2014-01-08 109477\_eng.xml