



HF-Regulator II for PL-T/C

HF-R 218 PL-T/C EII 220-240V 50/60Hz

Compact, high-frequency electronic dimming ballast, using the analog protocol (1-10 V) for PL-T, PL-C and PL-R lamps

Product data

• General Characteristics

Interface	1-10V
Application code	EII
Rated Lamptype	PL-T/C
Rated Number of Lamps	2 piece
Rated Ballast-Lamp Power	18
Line Voltage	220-240 V
Line Frequency	50/60 Hz
Housing	S 123x79x33
Energy Efficiency Index	A1
Lifetime 90% surv.@Tcaselife	50000 hr
Ignition Method	Programmed Start

• Operating Characteristics

Automatic restart	Yes
Operating frequency	40 (min), 100 (max) kHz
Mains voltage safety (AC)	-10%/+10%
Mains voltage performance (AC)	-8%/+6%
Inrush current Peak	28 (max) A
Inrush current Width	0.35 ms
Earth leakage current	0.5 (max) mA
Constant wattage deviation	-2%/+2%
Regulating level power	1%-100%
Ballast Lumen Factor	1.0 -
PowerFactor 100% output power	0.95 -
Battery voltage lamp ignition	198-254 V

Battery voltage running lamps	176-254
Overvoltage protection 320Vac	48 hr
Overvoltage protection 350Vac	2 hr
Control input protection	Yes (Basic insulation)
Max ballast on MCB(16A type B)	28 x
Stable lamp operation temp.	- [Not specified]
Crestfactor	1.7 (max) -
Hum and Noise level	Inaudible

• Wiring Characteristics

Cable-Cap output-wires to earth	75 pF
Cable-Cap output-wires mutual	30 pF
Conn.type input terminals	Insert
Conn.type output terminals	Insert
Conn.type ctrl input terminals	Insert
Striplength	7.5-8.5 mm
Dual fixture Master/Slave	Not applicable [Master/Slave oper. not applicable]
Wcs Control input terminals	0.50-1.50 mm ²
Wcs Input terminals	0.50-1.50 mm ²
Wcs Output terminals	0.50-1.50 mm ²

PHILIPS

HF-Regulator II for PL-T/C

• Temperature Characteristics

T-case life	65 C
T-case maximum	75 (max) C
T-ambient	-20 (min), 50 (max) C
T-storage	-25 (min), 80 (max) C

• Product Dimensions

Length A1	123.0 mm
Fixing Hole Distance	111.0 mm
Length A2	
Width B1	79.0 mm
Fixing Hole Distance	67.0 mm
Width B2	
Height C1	33.0 mm
Fixing Hole Diameter	4.5 mm
D1	

• Approval & Application Chars

EMI 9kHz .. 30 MHz	EN 55015
EMI 30 MHz .. 1000MHz	EN 55022 level B [Level = Class]
Safety Standard	IEC 61347-2-3
Performance Standard	IEC 60929
Quality Standard	ISO 9000:2000
Environmental Standard	ISO 14001
Harmonic current emissions	IEC 61000-3-2

EMC Immunity	IEC 61547
Vibrations	IEC 68-2-6 Fc
Bumps	IEC 68-2-29 Eb
Humidity	EN 61347-2-3 clause 11
Approval marks	ENEC / VDE-EMV
CE marking	Yes
Temperature marking	- [Not specified]
Emergency standard	IEC 60598-2-22

• Product Data

Order code	913700680166
Full product code	913700680166
Full product name	HF-R 218 PL-T/C EII 220-240V 50/60Hz
Order product name	HF-R 218 PL-T/C EII 220-240V 50/60Hz
Pieces per pack	1
Packing configuration	12
Packs per outerbox	12
Bar code on pack - EAN1	8718291176985
Bar code on outerbox - EAN3	8718291176992
Logistic code(s) - 12NC	913700680166
Net weight per piece	0.230 kg

Dimensional drawing

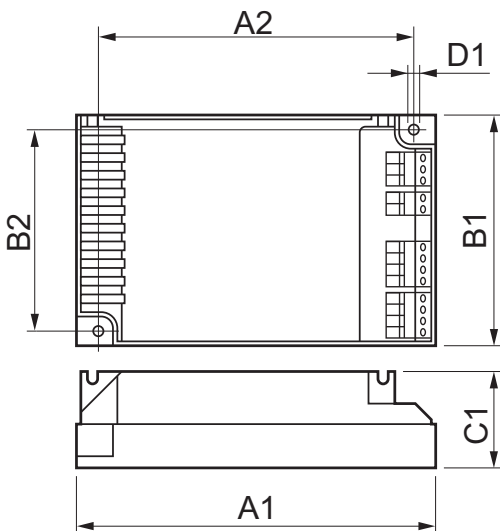

HF-R 218 PL-T/C EII 220-240V 50/60Hz

Product	A1 (Norm)	A2 (Norm)	B1 (Norm)	B2 (Norm)	C1 (Norm)	D1 (Norm)
HF-R 218 PL-T/C EII 220-240V 50/60Hz	123.0	111.0	79.0	67.0	33.0	4.5

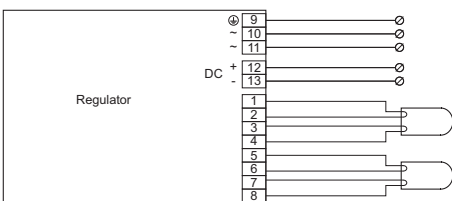



© 2014 Koninklijke Philips N.V. (Royal Philips)
All rights reserved.

Specifications are subject to change without notice. Trademarks are the property of Koninklijke Philips N.V. (Royal Philips) or their respective owners.

www.philips.com/lighting

2014, April 11
data subject to change