



1 2 3 4 5 6

identification 
for 0,75 mm²

male contact

identification

female contact

identification 
for 0,75 mm²

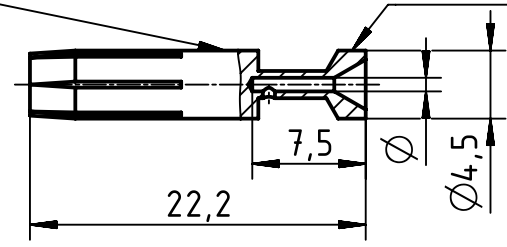
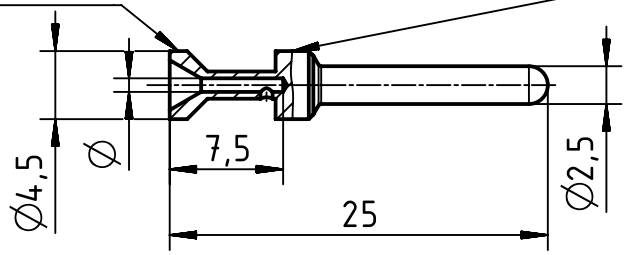

Part no. 09 33 000		Ø	Wire gauge		Stripping length	Identification	Recommended crimping tools			
Gold Tec			mm ²	AWG			09 99 000 0888	09 99 000 0001	09 99 000 0110	09 99 000 0021
male contact	female contact									
6327	6427	0,9	0,14-0,37	26-22	7,5	no groove	X	X		
6320	6420	1,15	0,5	20		no groove	X	X	X	X
6314	6414	1,3	0,75	18		1 groove 	X	X	X	X
6305	6405	1,45	1			1 groove	X	X	X	X
6304	6404	1,75	1,5	16		2 grooves	X	X	X	X
6302	6402	2,25	2,5	14		3 grooves	X	X	X	X
6306	6406	2,55	3	12		1 wide groove	X	X	X	
6307	6407	2,85	4			no groove	X	X	X	

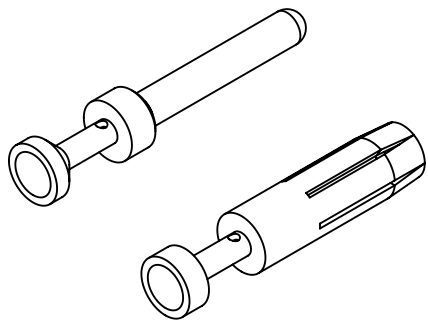

	All rights reserved	Scale 2:1	Free size tol.		Ref.
	Department EL PD	Created by FINKEV	Inspected by NICHTERLEIN	Standardisation RUETERA	Sub. 0933000642X v. 16.06.15
HARTING Electric GmbH & Co. KG D-32339 Espelkamp		Title Han E GoldTec contacts male/female			Date 2019-01-18
		Type TB	Number 09 33 000 6YYY		State Final Release
					Doc-Key / ECM-Nr. 100088681/UGD/006/B 500000145820
					Rev. B
					Page 1/1