

Precision Pocket Vernier Calipers



Precision Pocket Vernier Caliper

DIN 862

- for professional industry purposes
- stainless steel, hardened
- reading in mm/inch, scale laser engraved
- reading satin chrome finish
- jaws fine ground and lapped
- mono-block vernier
- flat depth gauge

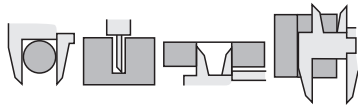
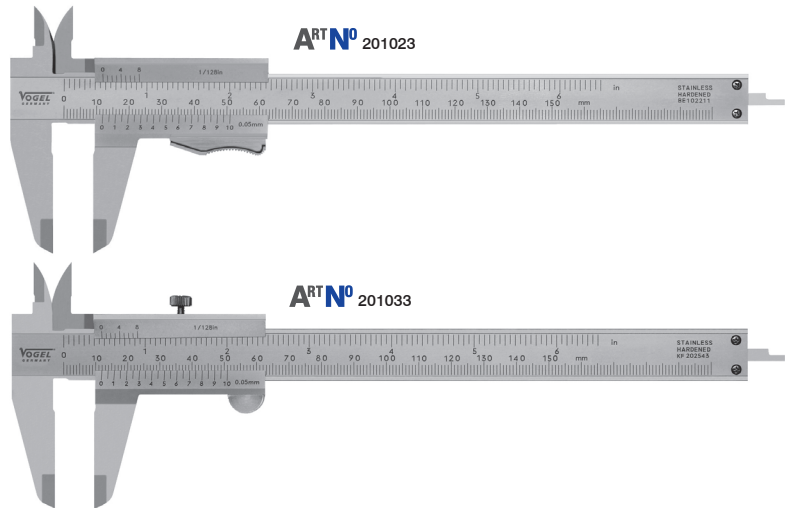

ART NO	type	mm / inch	mm bottom	inch top	mm	inch	mm	KG	ART NO CC
201023	thumb locking	150 / 6	0.05	1/128	40	16	flat	0.150	2094001
201033	fixing screw	150 / 6	0.05	1/128	40	16	flat	0.150	2094001



Pocket Vernier Caliper

DIN 862

- suitable for workshop use (standard)
- stainless steel, hardened
- reading in mm/inch, scale laser engraved
- reading satin chrome finish
- jaws fine ground and lapped
- mono-block vernier
- flat or round depth gauge

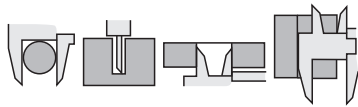
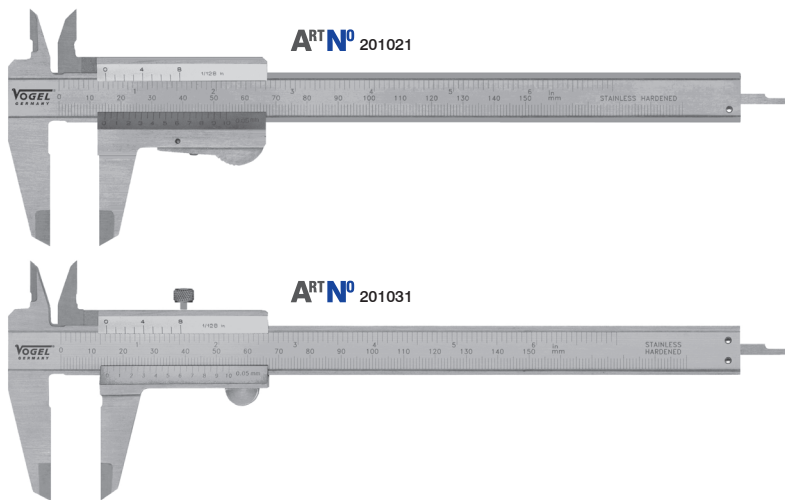

ART NO thumb locking	ART NO fixing screw	mm / inch	mm bottom	inch top	mm	inch	mm	KG	ART NO CC
201021	201031	150 / 6	0.05	1/128	40	16	flat	0.150	2094001
201022	201032	150 / 6	0.05	1/128	40	16	round	0.150	2094001
201024	201034	200 / 8	0.05	1/128	50	19	flat	0.170	2094001
201025	201035	150 / 6	0.02	1/1000	40	16	flat	0.150	2094001
201026	201036	200 / 8	0.02	1/1000	40/50	16/19	flat	0.170	2094001
-	201038	200 / 8	0.05	1/128	40	16	round	0.170	2094001
-	201013	300 / 12	0.05	1/128	60	20	flat	0.250	2094001
-	201015	300 / 12	0.02	1/1000	64	20	flat	0.250	2094001

2b

3

4

5

6

7

8

9

10

11

Precision Pocket Vernier Calipers

★★★★★ BLUE-LINE® Pocket Vernier Caliper DIN 862

- for craftsmen
- stainless, hardened
- reading in cm/inch, scale laser engraved
- scale and vernier satin chrome finish
- jaws fine ground, flat depth gauge
- mono-block vernier

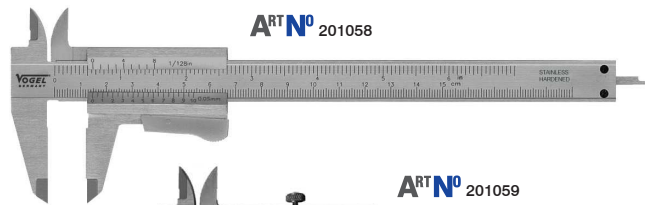
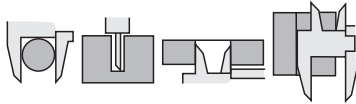

ART No	ART No	mm / inch	mm bottom	inch top				KG	ART No CC
thumb locking	fixing screw								
201058	201059	150 / 6	0.05	1/128	40	16	flat	0.155	2094001

★★★★★ BLUE-LINE® Pocket Vernier Caliper DIN 862

- simple quality for DIY and training purposes
- inox, hardened
- graduation in cm/inch, scale etched
- reading satin chrome finish, flat depth gauge
- jaws finely ground and lapped

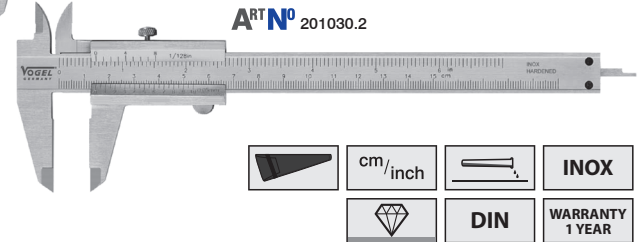
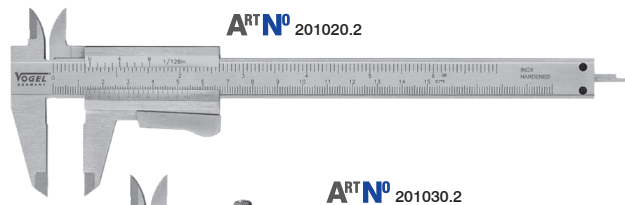
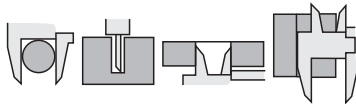

ART No	ART No	mm / inch	mm bottom	inch top				KG
thumb locking	fixing screw							
201020.2	201030.2	150 / 6	0.05	1/128	40	16	flat	0.155

★★★★★ BLUE-LINE® Pocket Vernier Caliper DIN 862

- with parallaxfree reading
- art.-no. 201060 with double-prism guide
- stainless steel, hardened
- graduation in mm/inch, laser engraved scale
- reading satin chrome finish
- jaws finely ground and lapped, flat depth gauge
- mono-block vernier

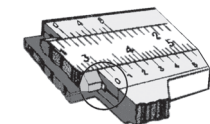
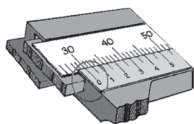
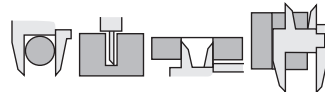

with double-prism guide

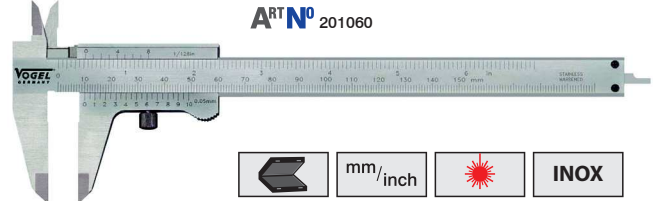
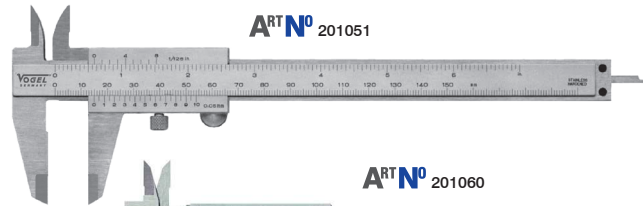
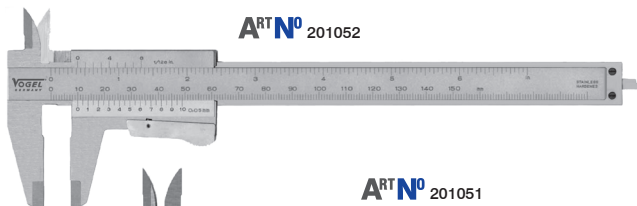

ART No	ART No	mm / inch	mm bottom	inch top				KG	ART No CC
thumb locking	fixing screw								
★★★★★ 201052	★★★★★ 201051	150 / 6	0.05	1/128	40	16	flat	0.155	2094001
★★★★★ 201054	★★★★★ 201053	150 / 6	0.02	1/1000	40	16	flat	0.155	2094001
-	★★★★★ 201060	150 / 6	0.05	1/128	40	16	flat	0.155	2094001

Pocket Vernier Calipers

★★★★★ BLUE-LINE® Pocket Vernier Caliper DIN 862

- with tungsten carbide measuring jaws and tips
- stainless steel, hardened
- graduation in mm/inch, laser engraved scale
- scale and vernier satin chrome finish
- jaws finely ground and lapped
- mono block vernier

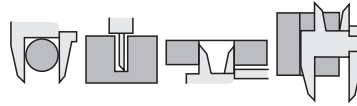
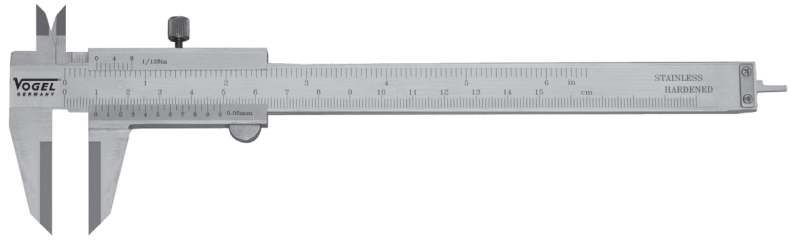

ART No	mm / inch	mm bottom	inch top	mm	mm	mm	KG	ART No CC
201039	150 / 6	0.05	1/128	40	16	flat	0.165	2094001

★★★★★ BLUE-LINE® Pocket Vernier Caliper DIN 862

- for left-handed use
- stainless steel, hardened
- graduation in mm/inch, laser engraved scale
- scale and vernier satin chrome finish
- jaws finely ground and lapped
- mono block vernier

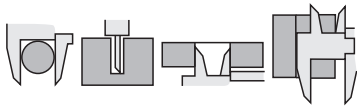
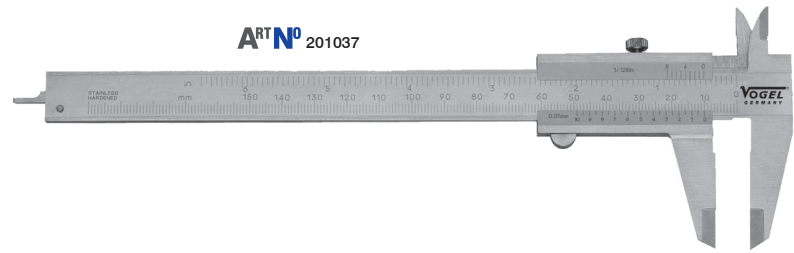
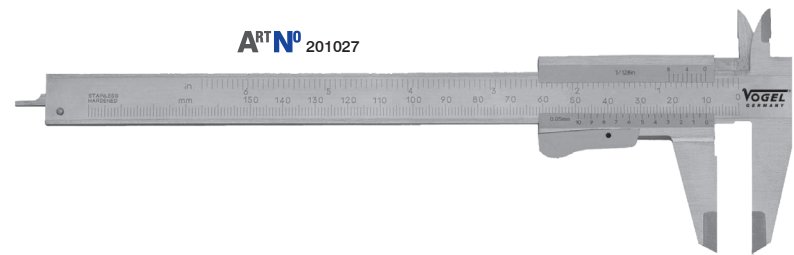

ART No thumb locking	ART No fixing screw	mm / inch	mm bottom	inch top	mm	mm	mm	KG	ART No CC
201027	201037	150 / 6	0.05	1/128	40	16	flat	0.155	2094001

★★★★★ BLUE-LINE® Pocket Vernier Caliper workshop grade

- with fine adjustment and long jaws
- stainless steel, hardened
- graduation in mm/inch, laser engraved scale
- scale and vernier satin chrome finish
- jaws finely ground and lapped
- mono block vernier
- with fine adjustment

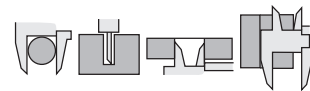
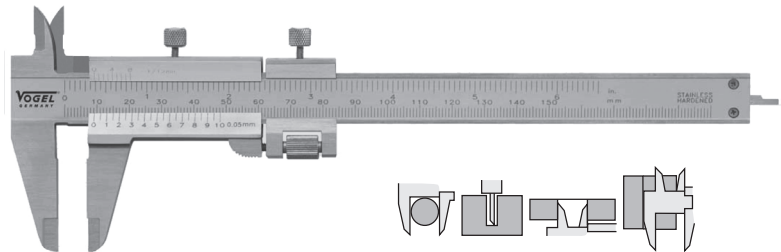

ART No	mm / inch	mm bottom	inch top	mm	mm	mm	KG	ART No CC
201062	130 / 5	0.05	1/128	40	16.5	flat	0.164	2094015
201063	130 / 5	0.02	1/1000	40	16.5	flat	0.164	2094015
201064	180 / 7	0.05	1/128	50	19.5	flat	0.200	2094020
201065	180 / 7	0.02	1/1000	50	19.5	flat	0.200	2094020

2b

3

4

5

6

7

8

9

10

11