

M12 male 90° / M12 female 90° shielded Cube67

PUR 0.5+0.25 shielded gn UL/CSA+drag ch. 7,5m

Cube67, 6-pole

Hybrid cable for communication and supply

Male 90° to female 90°

M12 - M12

6-pole used, shielded

Plastic housings with good resistance against chemicals and oils. The resistance to aggressive media should be individually tested for your application. Further details on request. Further cable lengths on request.

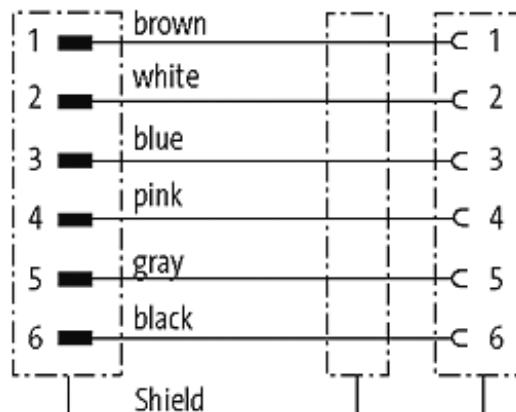
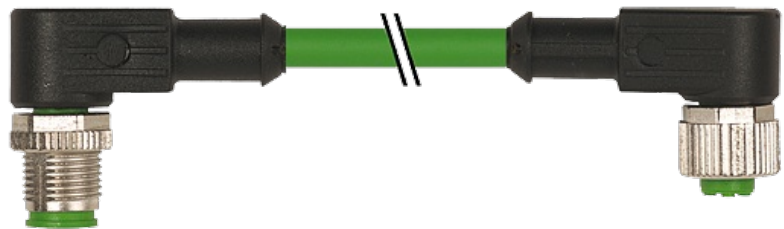
[Link to Product](#)**Illustration**

Male

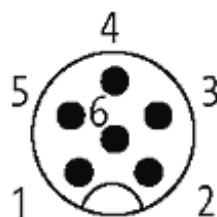

Female

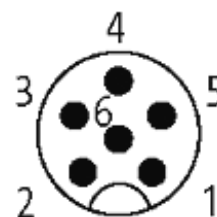

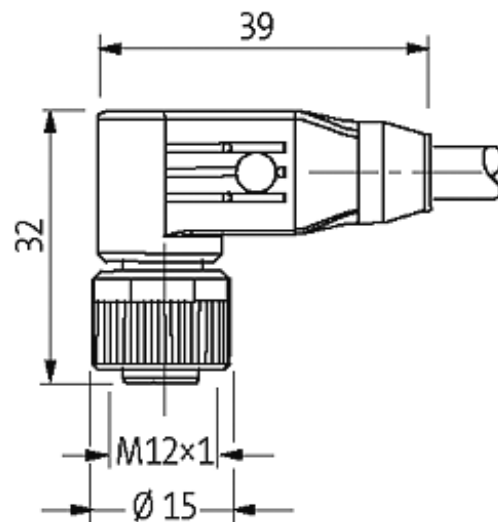
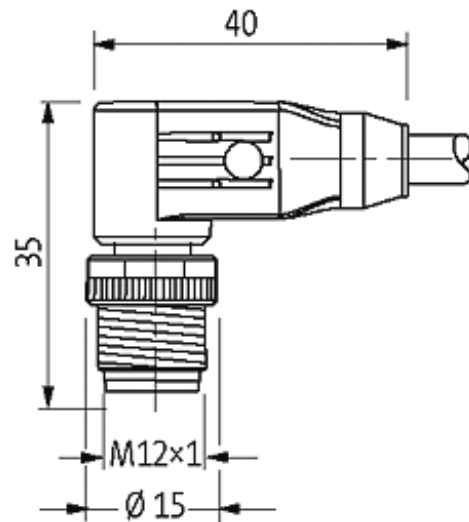

Product may differ from Image

Approvals



More Info

Cube67

Form

46061

Technical Data

Operating voltage	max. 30 V AC/DC
Operating current per contact	max. 4 A
Locking of ports	Screw thread M12 × 1 mm (recommended torque 0.6 Nm) self-securing

Protection IP67 inserted and tightened (EN 60529)

Cables

Cable number	802
No./diameter of wires	4×0.5 + 2×0.25 mm ²
Wire isolation	PP (br, bl, bk, wh), (gr, pk)
C-track properties	5 Mio.
Torsion	± 180°/m
Jacket Color	green
Shore hardness outer jacket	90 ± 5A
Material (jacket)	PUR (UL/CSA)
Outer diameter	approx. 7.9 mm
Bend radius (fixed)	5 × outer Ø
Bend radius (moving)	10 × outer Ø
Temperature range (fixed)	-50...+80 °C
Temperature range (mobile)	-40...+80 °C
Shielded	yes

Commercial data

country of origin	DE
customs tariff number	85444290
minimum order quantity	1