

SITOR FUSE-LINK 500A, AC 800V, SIZE 2



Figure similar

Model		
product brand name		SENTRON
Design of an identification indicator		front indicator
Design of the fuse link		SITOR, LV HRC design
General technical data		
Size of fuse system / acc. to DIN EN 60269-1		NH2
Operating class of the fuse link		aR
circuit-breaker / Design		3NE
Switching capacity		
Switching capacity current		
<ul style="list-style-type: none"> acc. to IEC 60947-2 / Rated value 	kA	100
Dissipation		
Active power loss		
<ul style="list-style-type: none"> for rated value of the current / with AC / in hot operating state / per pole 	W	155
Electricity		
rated current I_n / IEC, DIN/VDE / at 40 Cel	A	500
Current / with AC / Rated value	A	500
Mechanical Design		
mounting position		Any, preferably vertical
Environmental conditions		
Ambient temperature		
<ul style="list-style-type: none"> minimum 	°C	-20

• maximum

°C 50

Certificates

Equipment marking

- acc. to DIN EN 61346-2
- acc. to DIN EN 81346-2

F

F

General Product Approval

Declaration of Conformity



Further information

Information- and Downloadcenter (Catalogs, Brochures,...)

<http://www.siemens.com/lowvoltage/catalogs>

Industry Mall (Online ordering system)

<https://eb.automation.siemens.com/mall/en/WW/Catalog/Product/3NE43340B>

Service&Support (Manuals, Certificates, Characteristics, FAQs,...)

<http://support.automation.siemens.com/WW/view/en/3NE43340B/all>

Image database (product images, 2D dimension drawings, 3D models, device circuit diagrams, ...)

http://www.automation.siemens.com/bilddb/cax_en.aspx?mlfb=3NE43340B

CAX-Online-Generator

<http://www.siemens.com/cax>

Tender specifications

<http://ausschreibungstexte.siemens.com/tiplv>

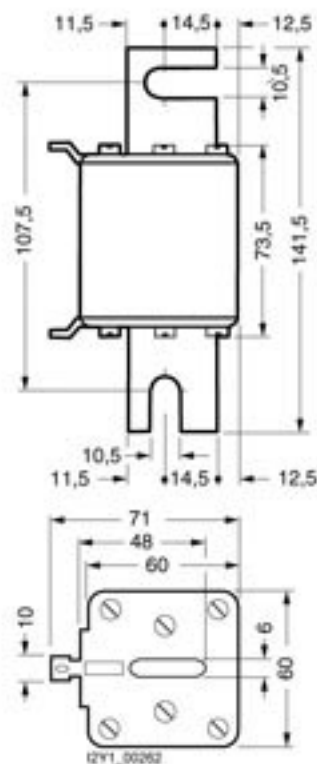

last modified:

11.03.2015