









CABLE RELEASE WITH HOLDER FOR 3RB30/3RB31
SIZE S00...S2

Certificates/ approvals:

General Product Approval	EMC	Declaration of Conformity	Shipping Approval
 CSA		 UL	 C-TICK
		 EG-Konf.	 ABS

Shipping Approval	other
 RINA	Environmental Confirmations

Further information

Information- and Downloadcenter (Catalogs, Brochures,...)
<http://www.siemens.com/industrial-controls/catalogs>

Industry Mall (Online ordering system)
<http://www.siemens.com/industrymall>

Cax online generator
<http://support.automation.siemens.com/WW/CAXorder/default.aspx?lang=en&mlfb=3RB39800B>

Service&Support (Manuals, Certificates, Characteristics, FAQs,...)
<http://support.automation.siemens.com/WW/view/en/3RB39800B/all>

Image database (product images, 2D dimension drawings, 3D models, device circuit diagrams, EPLAN macros, ...)
<http://www.automation.siemens.com/bilddb/index.aspx?attID9=3RB39800B&lang=en>

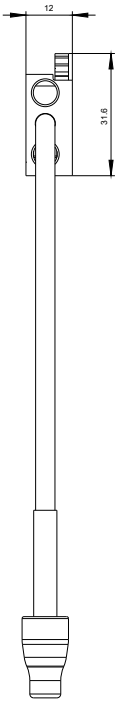

last modified:

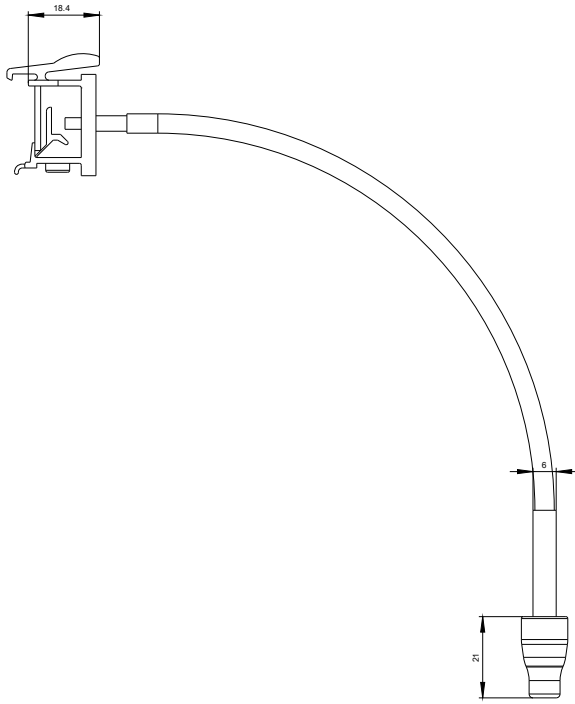

15.01.2015