



## Medical

	<b>Type SH5149</b> <b>6V 25W PY16-1,25</b>
	<b>Ordering - No.</b> <b>55149</b>
<b>Product Description</b>	Halogen Lamp with Prefocus Base
<b>Features</b>	Quartz Bulb, Exactly positioned Filament
<b>Applications</b>	Medical, Microscope, Analysis

## Technical Details

Category	HLWS5
Rated Voltage (V)	6
Wattage (W)	max. 27,5
Luminous Flux (lm)	525 ± 12%
Average Lifetime (h)	75
Base	PY16-1,25
Overall Length (mm)	max. 30
Bulb Diameter (mm)	max. 8,5
Light Center Length (mm)	1,25 ± 0,2
Operating Position	s90
Packaging Configuration	300 pcs.
Environmental Remark	Product don't contain lead or mercury and is conform with Directive 2002/95/EC "Restriction of the use of certain hazardous substances in electrical and electronic equipment".

## Drawing (in mm)

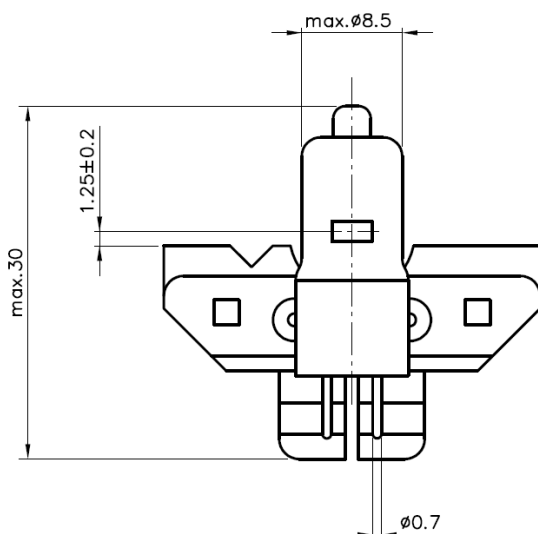

valid from	05.03.2014—V2—PN14/0072
replace for	29.01.2013—V1
file	55149.100.pdf