



Figure can vary

**Part no.: 66536000**  
**MLD510-R1L**  
**Single beam safety device receiver**



## Contents

- Technical data
- Dimensioned drawings
- Electrical connection
- Operation and display
- Suitable transmitters
- Part number code
- Accessories

## Technical data

<b>Basic data</b>	
Series	MLD 500
<b>Special design</b>	
Special design	Reflective element for laser alignment aid
<b>Functions</b>	
Functions	Automatic restart
<b>Characteristic parameters</b>	
Type	4 , IEC/EN 61496
SIL	3 , IEC 61508
SILCL	3 , IEC/EN 62061
Performance Level (PL)	e , EN ISO 13849-1:2008
MTTF <sub>d</sub>	204 years , EN ISO 13849-1
PFH <sub>D</sub>	6.6E-09 per hour
Mission time T <sub>M</sub>	20 years , EN ISO 13849-1
Category	4 , EN ISO 13849
<b>Electrical data</b>	
Protective circuit	Overvoltage protection Short circuit protected
<b>Performance data</b>	
Supply voltage U <sub>B</sub>	24 V , DC , -20 ... 20 %
Current consumption, max.	150 mA , Without external load
Fuse	External with max. 3 A
<b>Outputs</b>	
Number of safety-related switching outputs (OSSDs)	2 Piece(s)
<b>Safety-related switching outputs</b>	
Type	Safety-related switching output OSSD
Switching voltage high, min.	18.2 V
Switching voltage low, max.	2.5 V
Switching voltage, typ.	23 V
Voltage type	DC
Current load, max.	380 mA
Load inductivity	2,200,000 µH
Load capacity	0.3 µF
Residual current, max.	0.2 mA
Residual current, typ.	0.002 mA
Voltage drop	1 V
<b>Safety-related switching output 1</b>	
Switching element	Transistor , PNP
<b>Safety-related switching output 2</b>	
Switching element	Transistor , PNP
<b>Timing</b>	
Response time	25 ms
Restart delay time	100 ms

**Part no.: 66536000 – MLD510-R1L – Single beam safety device receiver**
**Connection**

Number of connections 1 Piece(s)

**Connection 1**

Type of connection	Connector
Function	Machine interface
Thread size	M12
Material	Metal
No. of pins	5 -pin

**Cable properties**

Permissible conductor cross section, typ.	0.25 mm <sup>2</sup>
Permissible cable resistance to load, max.	200 Ω

**Mechanical data**

Design	Cubic
Dimension (W x H x L)	52 mm x 193 mm x 64.7 mm
Housing material	Metal , Aluminum
Lens cover material	Plastic / PMMA
Material of end caps	Diecast zinc
Net weight	600 g
Housing color	Yellow, RAL 1021
Type of fastening	Groove mounting Swivel mount

**Operation and display**

Type of display	LED
Number of LEDs	1 Piece(s)

**Environmental data**

Ambient temperature, operation	-30 ... 55 °C
Ambient temperature, storage	-40 ... 75 °C
Relative humidity (non-condensing)	0 ... 95 %

**Certifications**

Degree of protection	IP 67
Protection class	III
Certifications	c CSA US c TÜV NRTL US TÜV Süd
US patents	US 6,418,546 B US 7,741,595 B

**Classification**

Customs tariff number	85365019
eCl@ss 8.0	27272701
eCl@ss 9.0	27272701
ETIM 5.0	EC001831
ETIM 6.0	EC001831

## Dimensioned drawings

All dimensions in millimeters

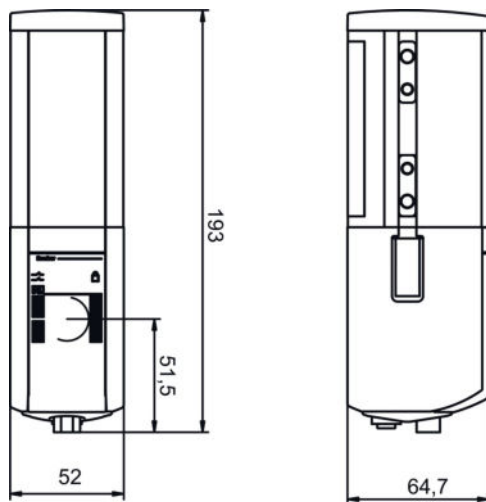

## Electrical connection

Connection 1	
Type of connection	Connector
Function	Machine interface
Thread size	M12
Type	Male
Material	Metal
No. of pins	5 -pin
Encoding	A-coded

Pin	Pin assignment	Conductor color
1	+24V	Brown
2	OSSD1	White
3	0 V	Blue
4	OSSD2	Black
5	n.c.	Gray

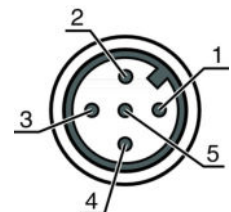

## Operation and display

### LEDs

LED	Display	Meaning
1	Red, continuous light	OSSD off.
	Green, continuous light	OSSD on
	Red, flashing, 1 Hz	External error
	Red, flashing, 10 Hz	Internal error
	Green, flashing, 1 Hz	Weak signal, device not optimally aligned or soiled.

Part no.: 66536000 – MLD510-R1L – Single beam safety device receiver

## Suitable transmitters

	Part no.	Designation	Article	Description
	66502000	MLD500-T1L	Single beam safety device transmitter	Operating range: 0.5 ... 70 m Light source: LED, Infrared Connection: Connector, M12, Metal, 5 -pin Special design: Integrated laser alignment aid

## Part number code

Part designation: **MLDxyy-zab/t**

MLD	Multiple light beam safety device
x	<b>Series:</b> 3: MLD 300 5: MLD 500
yy	<b>Function classes:</b> 00: transmitter 10: automatic restart 12: external testing 20: EDM/RES 30: muting 35: timing controlled 4-sensor muting
z	<b>Device type:</b> T: transmitter R: receiver RT: transceiver xT: transmitter with high range xR: receiver for high range
a	Number of beams
b	<b>Option:</b> L: integrated laser alignment aid (for transmitter/receiver) M: integrated status indicator (MLD 320, MLD 520) or integrated status and muting indicator (MLD 330, MLD 335, MLD 510/A, MLD 530, MLD 535) E: connection socket for external muting indicator (AS-i models only)
/t	<b>Safety-related switching outputs (OSSDs), connection technology:</b> -: transistor output, M12 plug A: integrated AS-i interface, M12 plug, (safety bus system)

### Note



A list with all available device types can be found on the Leuze electronic website at [www.leuze.com](http://www.leuze.com).

## Accessories

### Connection technology - Connection cables

	Part no.	Designation	Article	Description
	50133859	KD S-M12-5A-P1-020	Connection cable	Connection 1: Connector, M12, Axial, Female, A-coded, 5 -pin Connection 2: Open end Shielded: Yes Cable length: 2,000 mm Sheathing material: PUR

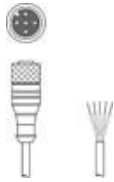
**Part no.: 66536000 – MLD510-R1L – Single beam safety device receiver**

	Part no.	Designation	Article	Description
	50133860	KD S-M12-5A-P1-050	Connection cable	Connection 1: Connector, M12, Axial, Female, A-coded, 5 -pin Connection 2: Open end Shielded: Yes Cable length: 5,000 mm Sheathing material: PUR
	50137014	KD S-M12-5A-P1-150	Connection cable	Connection 1: Connector, M12, Axial, Female, A-coded, 5 -pin Connection 2: Open end Shielded: Yes Cable length: 15,000 mm Sheathing material: PUR
	50136146	KD S-M12-5A-P1-250	Connection cable	Connection 1: Connector, M12, Axial, Female, A-coded, 5 -pin Connection 2: Open end Shielded: Yes Cable length: 10,000 mm Sheathing material: PVC

**Muting - Mounting systems**

	Part no.	Designation	Article	Description
	424421	BT-SB10	Mounting bracket set	Design of mounting device: Mounting clamp Fastening, at system: Through-hole mounting Mounting bracket, at device: Clampable Type of mounting device: Swiveling Swivel range: -8 ... 8 ° Material: Metal

**Services**

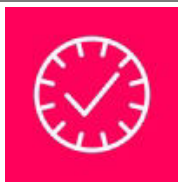
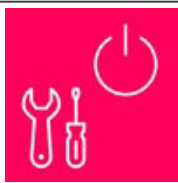
	Part no.	Designation	Article	Description
	S981050	CS40-I-140	Safety inspection "Safety light barriers"	Details: Checking of a safety light barrier application in accordance with current standards and guidelines. Inclusion of the device and machine data in a database, production of a test log per application. Conditions: It must be possible to stop the machine, support provided by customer's employees and access to the machine for Leuze employees must be ensured. Restrictions: Travel costs and accommodation expenses charged separately and according to expenditure.
	S981046	CS40-S-140	Start-up support	Details: For safety devices including stopping time measurement and initial inspection. Conditions: Devices and connection cables are already mounted, price not including travel costs and, if applicable, accommodation expenses. Restrictions: Max. 2 h., no mechanical (mounting) and electrical (wiring) work performed, no changes (attachments, wiring, programming) to third-party components in the nearby environment.

**Note**

A list with all available accessories can be found on the Leuze electronic website in the Download tab of the article detailed page.