

SWITCH-DISCONNECTOR 250A, FRAME SIZE 3, 3-
POLE SIDE OPERATING RIGHT BASIC UNIT
WITHOUT HANDLE FLAT TERMINAL



Model		
product brand name		SENTRON
Product designation		Switching device
Design of the product		3KD switch disconnectors
Design of the operating mechanism		without
Design of handle		without
Type of the driving mechanism / motor drive		No
General technical data		
Number of poles		3
Type of device		fixed mounting
circuit-breaker / Design		3KD3
Mechanical service life (switching cycles) / typical		10 000
Overvoltage category		IV
Voltage		
Insulation voltage / Rated value	V	1 000
Surge voltage resistance / Rated value	kV	12
Protection class		
Protection class IP		IP00
Protection class IP / on the front		IP00
Dissipation		
Active power loss		
<ul style="list-style-type: none"> with conventional rated thermal current / per pole 	W	7

Electricity

Continuous current		
• Rated value	A	250
• at 40 °C / Rated value	A	250
• at 45 °C / Rated value	A	250
• at 50 °C / Rated value	A	250
• at 55 °C / Rated value	A	250
• at 60 °C / Rated value	A	250
• at 65 °C / Rated value	A	250
• at 70 °C / Rated value	A	250
Short-time current resistance (I _{cw}) / limited to 1 s / Rated value	kA	13

Main circuit

Operating power		
• at AC-23 A / at 400 V / at 50/60 Hz / Rated value	kW	132
• at AC-23 A / at 500 V / at 50/60 Hz / Rated value	kW	160
• at AC-23 A / at 690 V / at 50/60 Hz / Rated value	kW	220
Operating voltage		
• with AC / at 50/60 Hz / Rated value	V	690

Auxiliary circuit

Number of CO contacts / for auxiliary contacts		0
Number of NC contacts / for auxiliary contacts		6
Number of NO contacts / for auxiliary contacts		6

Suitability

Suitability for use		
• Main switch		Yes
• switch disconnecter		Yes
• EMERGENCY OFF switch		No
• safety switch		Yes
• maintenance/repair switch		Yes

Product details

Product feature / interlock		No
Product component		
• Trip indicator		No
• Voltage trigger		No
• undervoltage release		No
• undervoltage release with leading contact		No
Product expansion		

• Auxiliary switch	Yes
• optional	
— motor drive	No
— Voltage trigger	No

Connections

Type of electrical connection

• for main current circuit	flat connector
----------------------------	----------------

Mechanical Design

Height	mm	164
Width	mm	198.5
Depth	mm	95
mounting position		any
Mounting type		floor mounting
Mounting type		
• front mounting with 4-hole attachment		No
• front mounting with central attachment		No
• rail mounting		No

Environmental conditions

Ambient temperature

• during operation / minimum	°C	-25
• during operation / maximum	°C	70
• during storage / minimum	°C	-50
• during storage / maximum	°C	80

Certificates

Equipment marking / acc. to DIN EN 61346-2

Q

General Product Approval

Declaration of Conformity



Further information

Information- and Downloadcenter (Catalogs, Brochures,...)

<http://www.siemens.com/lowvoltage/catalogs>

Industry Mall (Online ordering system)

<https://eb.automation.siemens.com/mall/en/WW/Catalog/Product/3KD38340PE400>

Service&Support (Manuals, Certificates, Characteristics, FAQs,...)

<http://support.automation.siemens.com/WW/view/en/3KD38340PE400/all>

Image database (product images, 2D dimension drawings, 3D models, device circuit diagrams, ...)

http://www.automation.siemens.com/bilddb/cax_en.aspx?mfb=3KD38340PE400

Cx-Online-Generator

<http://www.siemens.com/cax>

Tender specifications

<http://ausschreibungstexte.siemens.com/tiplv>

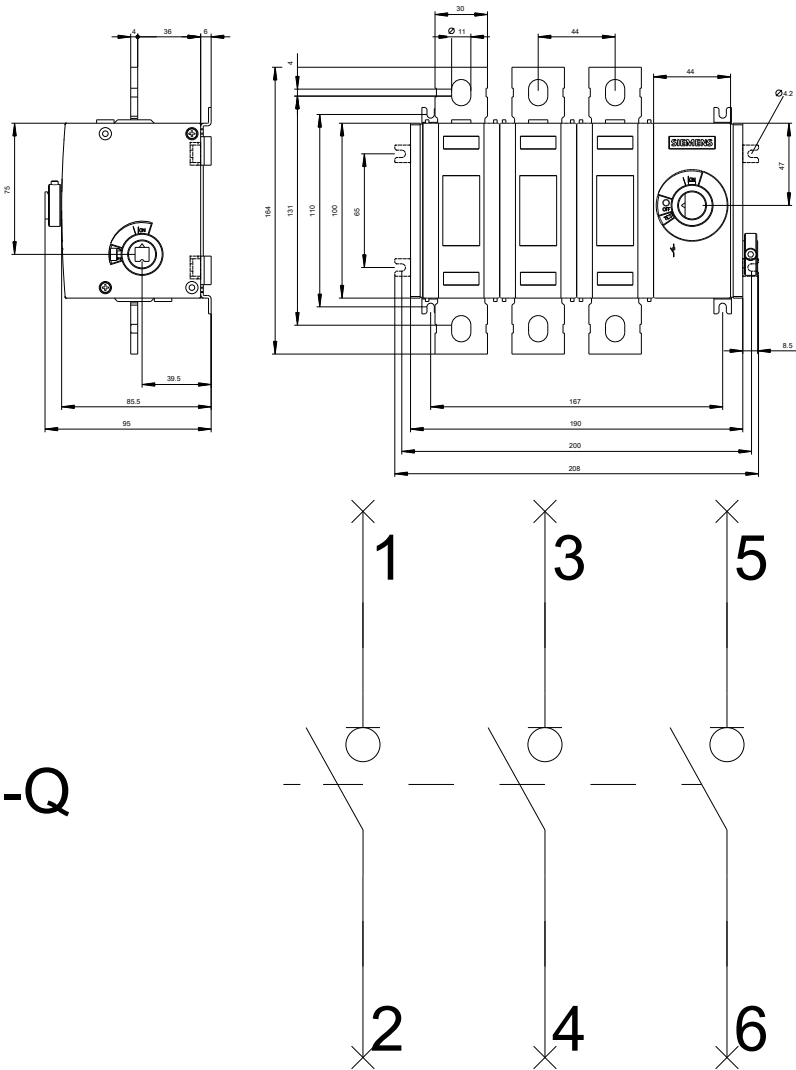

last modified:

11.03.2015