



SIRIUS POSITION SWITCH PLASTIC ENCLOSURE 40MM, TO EN50041 DEVICE CONNECTION 1X (M20X1.5) 1NO/2NC SNAP-ACTION CONTACTS METAL ROLLER LEVER AND PLASTIC ROLLER 22MM

Product designation		standard position switch
Manufacturer article number		
<ul style="list-style-type: none"> • of the supplied basic switch • of the supplied actuator head for position switches • of the supplied switching contacts • of the supplied empty enclosure with cover 		3SE5132-0LA00 3SE5000-0AE05 3SE5000-0LA00 3SE5132-0AA00

General technical data:

Product function		
<ul style="list-style-type: none"> • positive opening 		Yes
Insulation voltage		
<ul style="list-style-type: none"> • Rated value 	V	400
Degree of pollution		class 3
Shock resistance		30g / 11 ms
Vibration resistance		0.35 mm / 5g
Surge voltage resistance Rated value	kV	6
Mechanical service life (switching cycles)		
<ul style="list-style-type: none"> • typical 		15 000 000
Electrical endurance (switching cycles)		
<ul style="list-style-type: none"> • at AC-15 at 230 V typical 		100 000
Electrical endurance (switching cycles) with contactor 3RH11, 3RT1016, 3RT1017, 3RT1024, 3RT1025, 3RT1026 typical		10 000 000
Electrical operating cycles in one hour with contactor 3RH11, 3RT1016, 3RT1017, 3RT1024, 3RT1025, 3RT1026		6 000

Thermal current	A	10
Material of the enclosure of the switch head		plastic
Protection class IP		IP66/IP67
Equipment marking		B
<ul style="list-style-type: none"> • acc. to DIN EN 61346-2 • acc. to DIN EN 81346-2 		B
Active principle		mechanical
Repeat accuracy	mm	0.05
Explosion protection category for dust		none
Explosion protection category for gas		none
Minimum actuating force in activation direction	N	10
Operating current at AC-15		
<ul style="list-style-type: none"> • at 230 V Rated value • at 400 V Rated value 	A	1.5
	A	4
Operating current		
<ul style="list-style-type: none"> • at DC-13 at 125 V Rated value 	A	0.55
Operating current		
<ul style="list-style-type: none"> • at DC-13 — at 24 V Rated value 	A	3

Enclosure:

Design of the housing		block, narrow
Material of the enclosure		plastic
Coating of the enclosure		Other types
Design of the housing acc. to standard		Yes

Drive Head:

Design of the operating mechanism		metal lever, plastic roller
Standard-compliant actuator head		EN 50041
Shape of the switch head		roller
Design of the switching function		positive opening

Connections/ Terminals:

Type of electrical connection		screw-type terminals
Type of connectable conductor cross-section		
<ul style="list-style-type: none"> • solid • finely stranded with core end processing • finely stranded without core end processing • for AWG conductors 		1x (0.5 ... 1.5 mm ²), 2x (0.5 ... 0.75 mm ²)
		1x (0.5 ... 1.5 mm ²), 2x (0.5 ... 0.75 mm ²)
		1x (0.5 ... 1.5 mm ²), 2x (0.5 ... 0.75 mm ²)
— solid		1x (20 ... 16), 2x (20 ... 18)
— stranded		1x (20 ... 16), 2x (20 ... 18)

Mechanical data:

Cable entry type		1x (M20 x 1.5)
-------------------------	--	----------------

Communication/ Protocol:

Design of the interface		without
-------------------------	--	---------





Ambient conditions:

Ambient temperature		
• during operation	°C	-25 ... +85
• during storage	°C	-40 ... +90

Installation/ mounting/ dimensions:

mounting position		any
Mounting type		screw fixing

Certificates/ approvals:

General Product Approval	Declaration of Conformity	Test Certificates	other
 CSA	 UL		 EG-Konf.
		Special Test Certificate	Confirmation

Further information

Information- and Downloadcenter (Catalogs, Brochures,...)

<http://www.siemens.com/industrial-controls/catalogs>

Industry Mall (Online ordering system)

<http://www.siemens.com/industrymall>

Cax online generator

<http://support.automation.siemens.com/WW/CAXorder/default.aspx?lang=en&mlfb=3SE51320LE05>

Service&Support (Manuals, Certificates, Characteristics, FAQs,...)

<http://support.automation.siemens.com/WW/view/en/3SE51320LE05/all>

Image database (product images, 2D dimension drawings, 3D models, device circuit diagrams, EPLAN macros, ...)

http://www.automation.siemens.com/bilddb/cax_de.aspx?mlfb=3SE51320LE05&lang=en

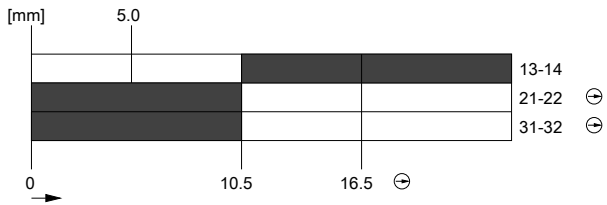
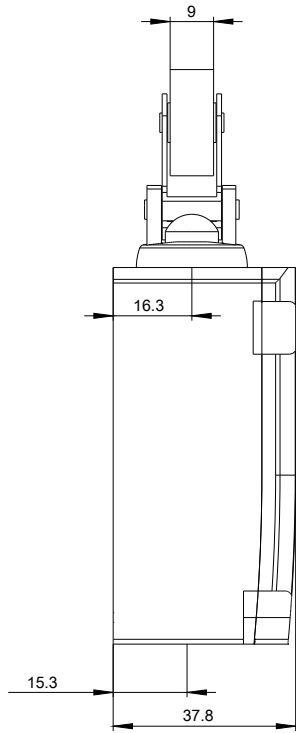
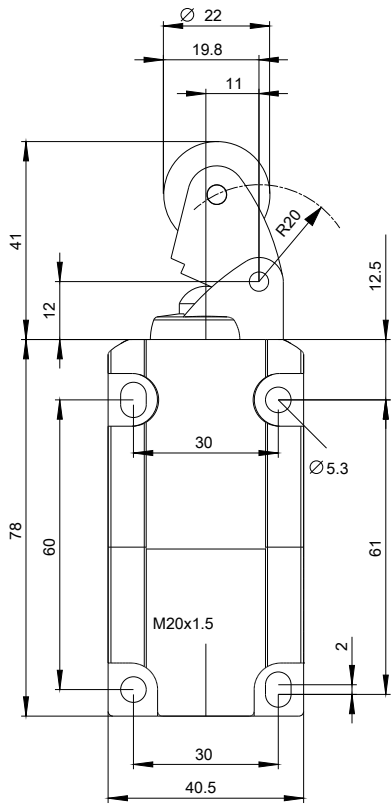

last modified:

09.03.2015