

Technisches Datenblatt

Artnr.	AGM95SS
Nennspannung	12V
Nennkapazität	95 AH (c20)
Kälteprüfstrom -18°C (EN)	850 A (EN)
Elektrolyt	verdünnte Schwefelsäure diluted sulphuric acid
Elektrolytdichte	1,28 +/- 0,01 Kg/l (25° C)
Abmessungen (LxBxH)	353 x 175 x 190 mm
Schaltung	0

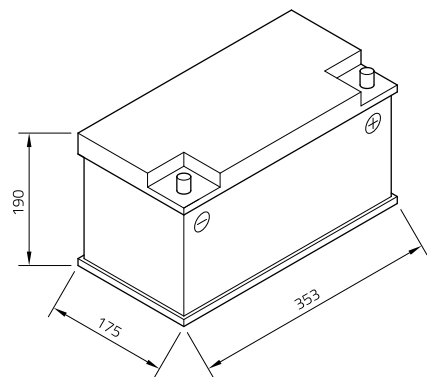
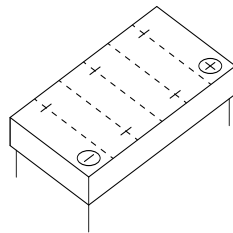

Technologie	Verschlossene AGM-Batterie Elektrolyt in Vlies gebunden gefüllt und geladen absolut wartungsfrei
-------------	--

Polausführung	1
---------------	---

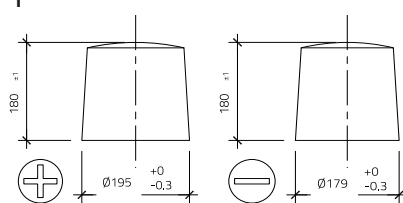

Bodenleiste	B13
-------------	-----

