

## Infrared Emitting Diode, RoHS Compliant, 875 nm, GaAlAs

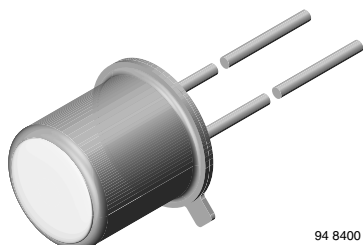

94 8400

### DESCRIPTION

TSTA7500 is an infrared, 875 nm emitting diode in GaAlAs technology in a hermetically sealed TO-18 package with flat glass window.

### FEATURES

- Package type: leaded
- Package form: TO-18
- Dimensions (in mm):  $\varnothing$  4.7
- Peak wavelength:  $\lambda_p = 875$  nm
- High reliability
- High radiant power
- High radiant intensity
- Angle of half intensity:  $\varphi = \pm 30^\circ$
- Low forward voltage
- Suitable for high pulse current operation
- Good spectral matching with Si photodetectors
- Lead (Pb)-free component in accordance with RoHS 2002/95/EC and WEEE 2002/96/EC



**RoHS**  
COMPLIANT

### APPLICATIONS

- Radiation source near infrared range

### PRODUCT SUMMARY

COMPONENT	$I_e$ (mW/sr)	$\varphi$ (deg)	$\lambda_p$ (nm)	$t_r$ (ns)
TSTA7500	6	$\pm 30$	875	600

#### Note

Test conditions see table "Basic Characteristics"

### ORDERING INFORMATION

ORDERING CODE	PACKAGING	REMARKS	PACKAGE FORM
TSTA7500	Bulk	MOQ: 1000 pcs, 1000 pcs/bulk	TO-18

#### Note

MOQ: minimum order quantity

### ABSOLUTE MAXIMUM RATINGS

PARAMETER	TEST CONDITION	SYMBOL	VALUE	UNIT
Reverse voltage		$V_R$	5	V
Forward current		$I_F$	100	mA
Peak forward current	$t_p/T = 0.5, t_p \leq 100 \mu s$	$I_{FM}$	200	mA
Surge forward current	$t_p \leq 100 \mu s$	$I_{FSM}$	2.5	A
Power dissipation		$P_V$	180	mW
	$T_{case} \leq 25^\circ C$	$P_V$	500	mW
Junction temperature		$T_j$	100	$^\circ C$
Storage temperature range		$T_{stg}$	- 55 to + 100	$^\circ C$
Thermal resistance junction/ambient	leads not soldered	$R_{thJA}$	450	K/W
Thermal resistance junction/case	leads not soldered	$R_{thJC}$	150	K/W

#### Note

$T_{amb} = 25^\circ C$ , unless otherwise specified



Fig. 1 - Power Dissipation Limit vs. Ambient Temperature

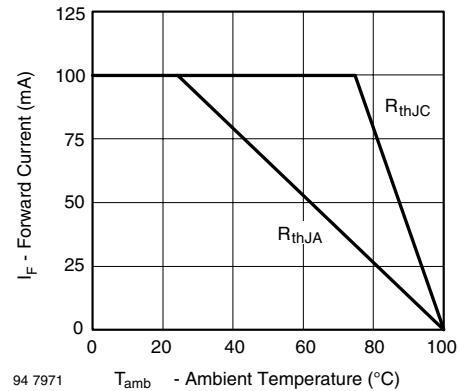

Fig. 2 - Forward Current Limit vs. Ambient Temperature

<b>BASIC CHARACTERISTICS</b>						
PARAMETER	TEST CONDITION	SYMBOL	MIN.	TYP.	MAX.	UNIT
Forward voltage	$I_F = 100 \text{ mA}$ , $t_p \leq 20 \text{ ms}$	$V_F$		1.4	1.8	V
Breakdown voltage	$I_R = 100 \text{ } \mu\text{A}$	$V_{(BR)}$	5			V
Junction capacitance	$V_R = 0 \text{ V}$ , $f = 1 \text{ MHz}$ , $E = 0$	$C_j$		20		pF
Radiant intensity	$I_F = 100 \text{ mA}$ , $t_p \leq 20 \text{ ms}$	$I_e$	3.5	6	16	mW/sr
Radiant power	$I_F = 100 \text{ mA}$ , $t_p \leq 20 \text{ ms}$	$\phi_e$		10		mW
Temperature coefficient of $\phi_e$	$I_F = 100 \text{ mA}$	$TK\phi_e$		- 0.7		%/K
Angle of half intensity		$\varphi$		$\pm 30$		deg
Peak wavelength	$I_F = 100 \text{ mA}$	$\lambda_p$		875		nm
Spectral bandwidth	$I_F = 100 \text{ mA}$	$\Delta\lambda$		80		nm
Rise time	$I_F = 100 \text{ mA}$	$t_r$		600		ns
	$I_F = 1.5 \text{ A}$ , $t_p/T = 0.01$ , $t_p \leq 10 \text{ } \mu\text{s}$	$t_r$		300		ns
Virtual source diameter		$d$		0.5		mm

**Note**
 $T_{amb} = 25 \text{ }^\circ\text{C}$ , unless otherwise specified

**BASIC CHARACTERISTICS**
 $T_{amb} = 25 \text{ }^\circ\text{C}$ , unless otherwise specified

Fig. 3 - Pulse Forward Current vs. Pulse Duration

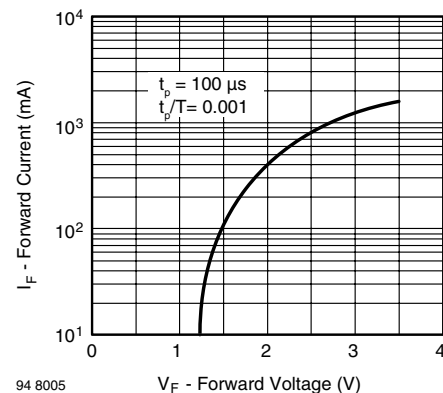

Fig. 4 - Forward Current vs. Forward Voltage



Fig. 5 - Relative Forward Voltage vs. Ambient Temperature



Fig. 8 - Rel. Radiant Intensity/Power vs. Ambient Temperature

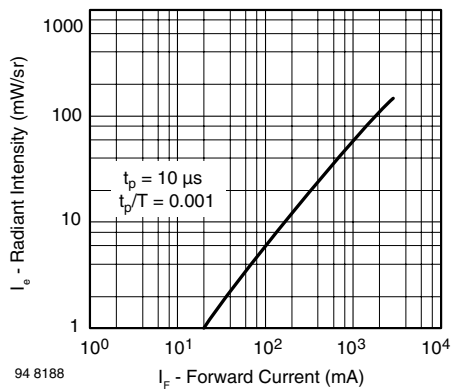

Fig. 6 - Radiant Intensity vs. Forward Current

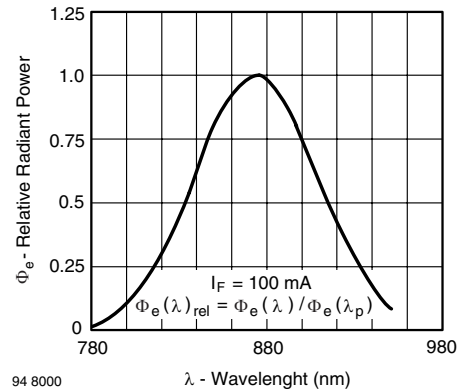

Fig. 9 - Relative Radiant Power vs. Wavelength

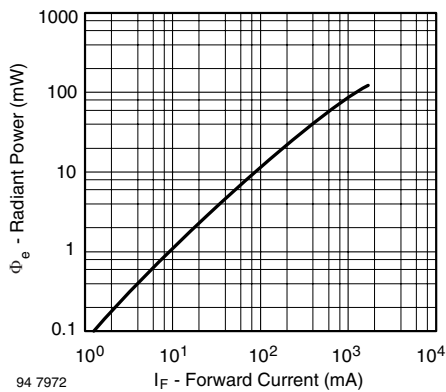

Fig. 7 - Radiant Power vs. Forward Current

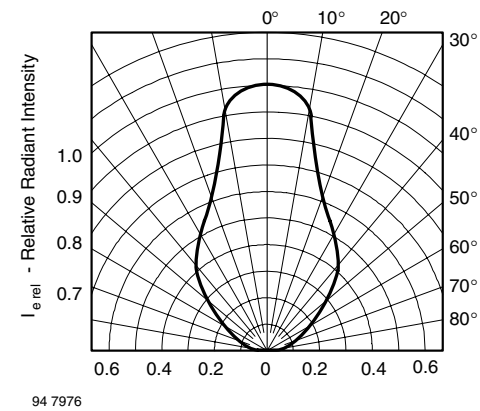
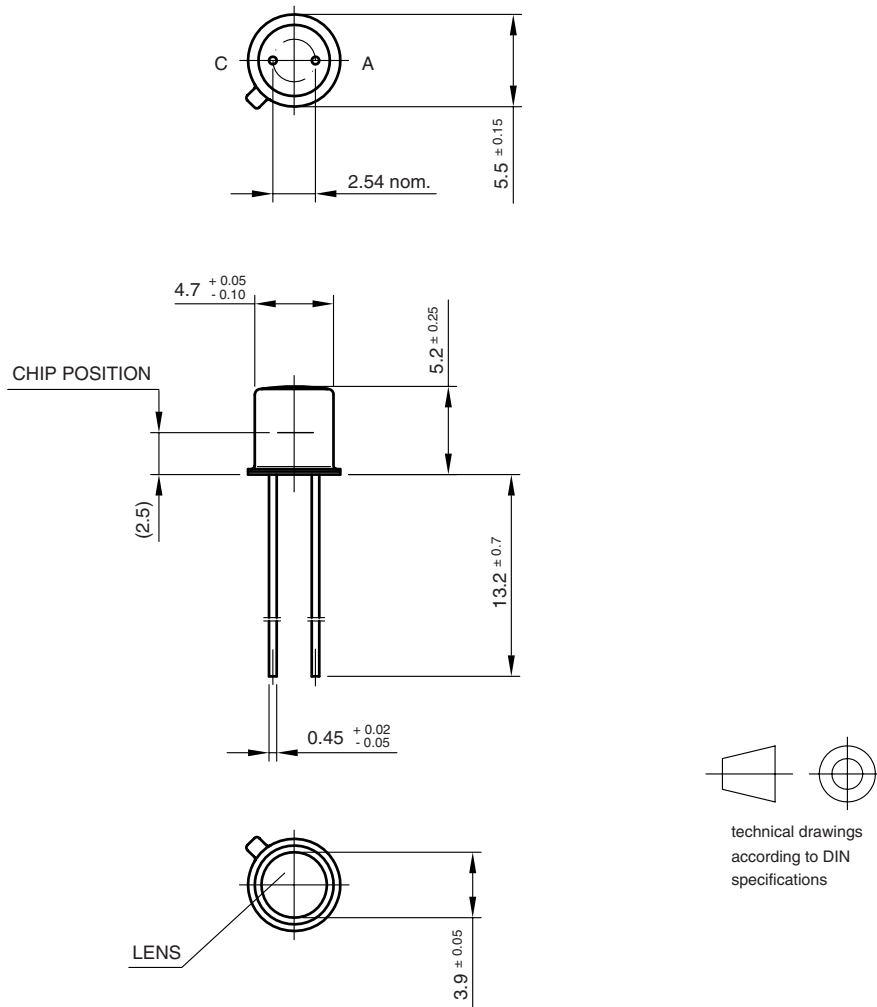

Fig. 10 - Relative Radiant Intensity vs. Angular Displacement



**PACKAGE DIMENSIONS** in millimeters



Drawing-No.: 6.503-5001.01-4  
Issue: 2; 24.08.98  
96 12173



## Disclaimer

ALL PRODUCT, PRODUCT SPECIFICATIONS AND DATA ARE SUBJECT TO CHANGE WITHOUT NOTICE TO IMPROVE RELIABILITY, FUNCTION OR DESIGN OR OTHERWISE.

Vishay Intertechnology, Inc., its affiliates, agents, and employees, and all persons acting on its or their behalf (collectively, "Vishay"), disclaim any and all liability for any errors, inaccuracies or incompleteness contained in any datasheet or in any other disclosure relating to any product.

Vishay makes no warranty, representation or guarantee regarding the suitability of the products for any particular purpose or the continuing production of any product. To the maximum extent permitted by applicable law, Vishay disclaims (i) any and all liability arising out of the application or use of any product, (ii) any and all liability, including without limitation special, consequential or incidental damages, and (iii) any and all implied warranties, including warranties of fitness for particular purpose, non-infringement and merchantability.

Statements regarding the suitability of products for certain types of applications are based on Vishay's knowledge of typical requirements that are often placed on Vishay products in generic applications. Such statements are not binding statements about the suitability of products for a particular application. It is the customer's responsibility to validate that a particular product with the properties described in the product specification is suitable for use in a particular application. Parameters provided in datasheets and/or specifications may vary in different applications and performance may vary over time. All operating parameters, including typical parameters, must be validated for each customer application by the customer's technical experts. Product specifications do not expand or otherwise modify Vishay's terms and conditions of purchase, including but not limited to the warranty expressed therein.

Except as expressly indicated in writing, Vishay products are not designed for use in medical, life-saving, or life-sustaining applications or for any other application in which the failure of the Vishay product could result in personal injury or death. Customers using or selling Vishay products not expressly indicated for use in such applications do so at their own risk. Please contact authorized Vishay personnel to obtain written terms and conditions regarding products designed for such applications.

No license, express or implied, by estoppel or otherwise, to any intellectual property rights is granted by this document or by any conduct of Vishay. Product names and markings noted herein may be trademarks of their respective owners.

## Material Category Policy

**Vishay Intertechnology, Inc. hereby certifies that all its products that are identified as RoHS-Compliant fulfill the definitions and restrictions defined under Directive 2011/65/EU of The European Parliament and of the Council of June 8, 2011 on the restriction of the use of certain hazardous substances in electrical and electronic equipment (EEE) - recast, unless otherwise specified as non-compliant.**

**Please note that some Vishay documentation may still make reference to RoHS Directive 2002/95/EC. We confirm that all the products identified as being compliant to Directive 2002/95/EC conform to Directive 2011/65/EU.**

**Vishay Intertechnology, Inc. hereby certifies that all its products that are identified as Halogen-Free follow Halogen-Free requirements as per JEDEC JS709A standards. Please note that some Vishay documentation may still make reference to the IEC 61249-2-21 definition. We confirm that all the products identified as being compliant to IEC 61249-2-21 conform to JEDEC JS709A standards.**