

# P15

**workshop tool trolley**  
with 338 tools for 6 drawers  
**815.6338**

---

# THE COMPACT HEAVYWEIGHT

P15



**Workshop trolley P15**  
with 8 compartments  
873.1008

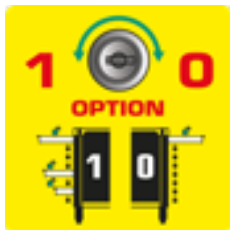

**DUO Lock** Brilliant locking system



**Eight drawers** each load capacity up to 50 kg



Stable **ball bearing**



**Plastic Surface**

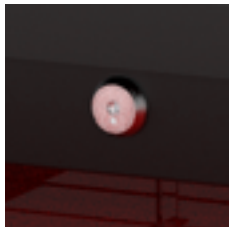

**Lock** lockable



**Anti-static castors** with brakes



Integrated **corner protection**



**Paper roll holder** included



**Can holder** included

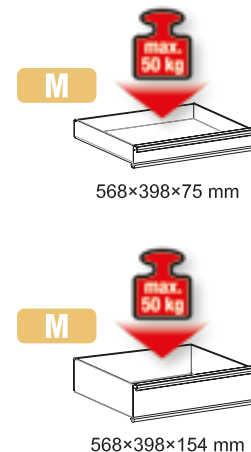
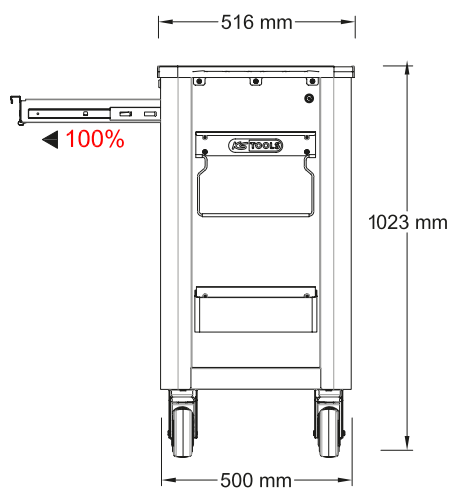
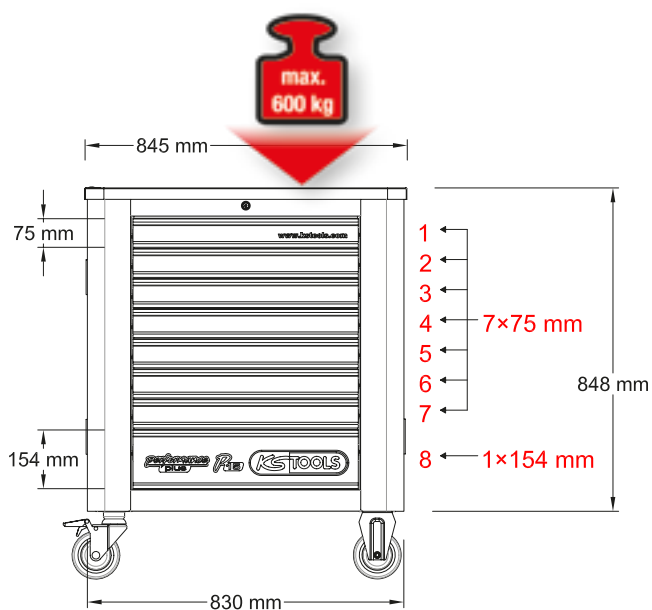

# P15 workshop tool trolley set with 338 tools for 6 drawers

815.6338



M



Screwdriver set in foam insert

811.1027

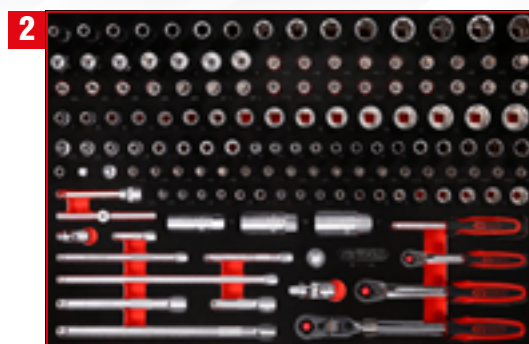

1/4" + 3/8" socket spanner set in foam insert

811.1142

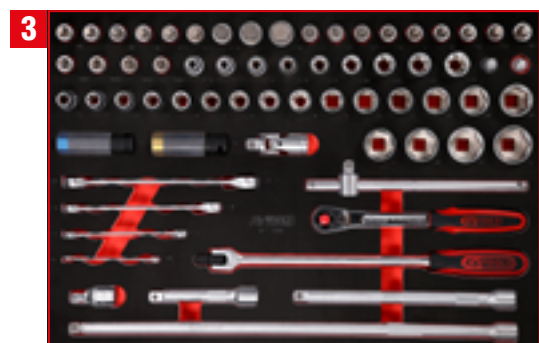

1/2" socket spanner set in foam insert

811.0066



Screw spanner set in foam insert

811.2041

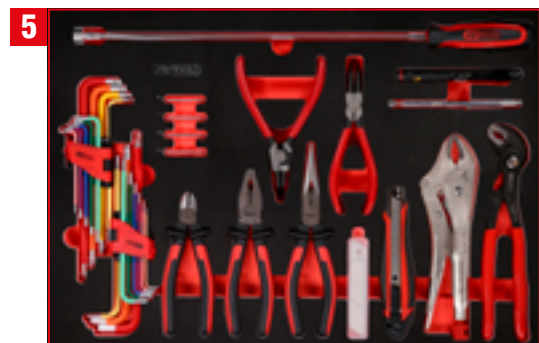

Pliers and angle spanner set in foam insert

811.0045



Hammer and chisel set in foam insert

811.1017



811.1027

**M** Screwdriver set

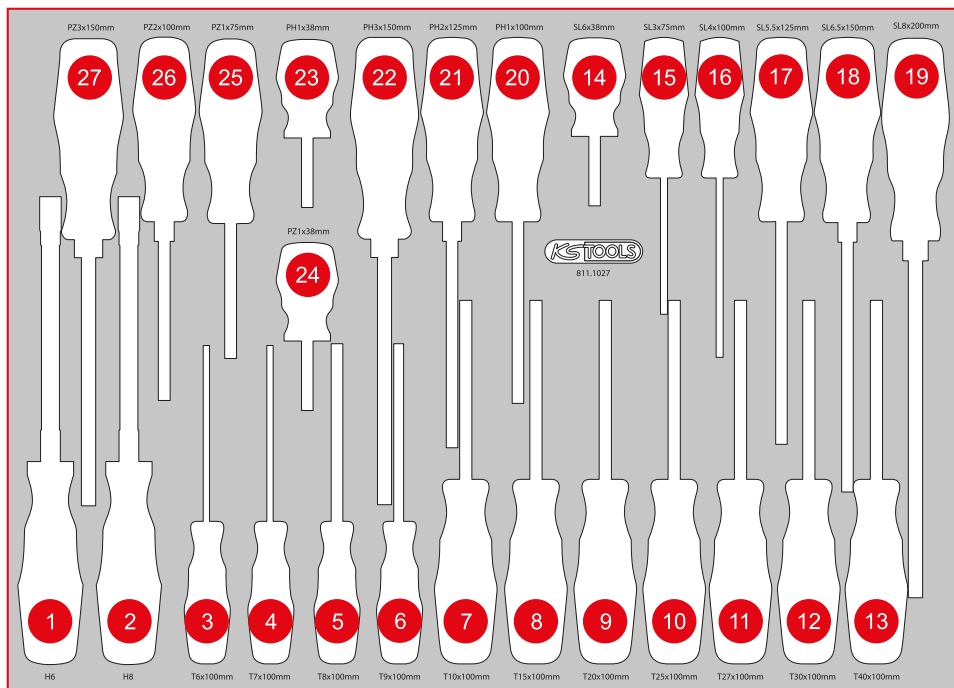
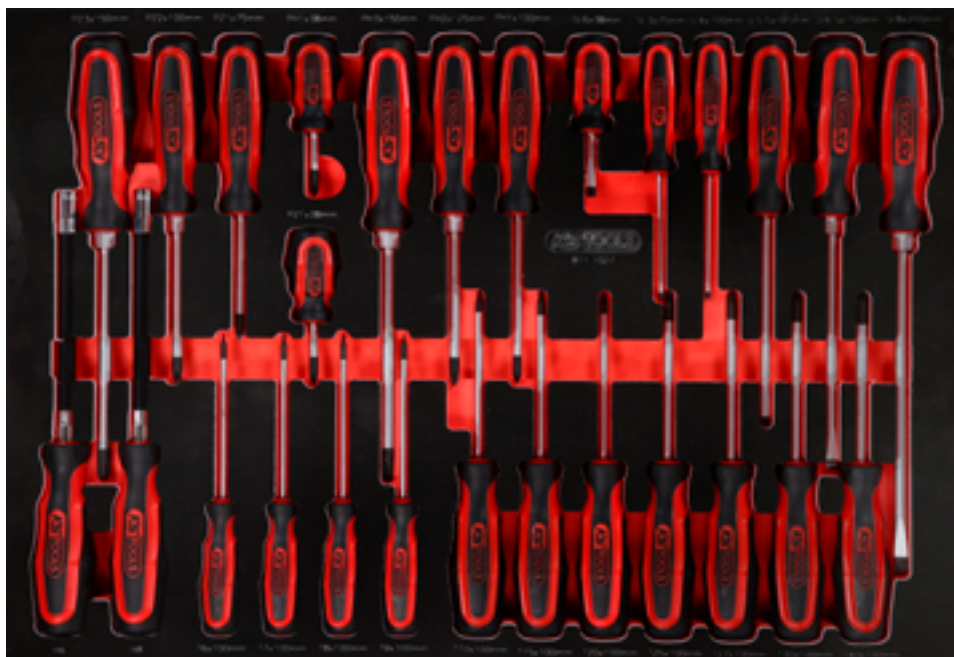

Pos.	Code	Description	pcs
1	159.1126	ERGOTORQUEplus Socket screwdriver, 6 mm	1
2	159.2128	ERGOTORQUEplus Socket screwdriver, 8 mm	1
3	159.1134	ERGOTORQUEplus screwdriver, Torx, T6	1
4	159.1135	ERGOTORQUEplus screwdriver, Torx, T7	1
5	159.1030	ERGOTORQUEplus screwdriver, Torx, T8	1
6	159.1031	ERGOTORQUEplus screwdriver, Torx, T9	1
7	159.1032	ERGOTORQUEplus screwdriver, Torx, T10	1
8	159.1033	ERGOTORQUEplus screwdriver, Torx, T15	1
9	159.1034	ERGOTORQUEplus screwdriver, Torx, T20	1
10	159.1035	ERGOTORQUEplus screwdriver, Torx, T25	1
11	159.1036	ERGOTORQUEplus screwdriver, Torx, T27	1
12	159.1037	ERGOTORQUEplus screwdriver, Torx, T30	1
13	159.1038	ERGOTORQUEplus screwdriver, Torx, T40	1
14	159.1001	ERGOTORQUEplus screwdriver for slotted screws, 6 mm, stubby	1
15	159.1002	ERGOTORQUEplus screwdriver for slotted screws, 3 mm, 155 mm	1
16	159.1004	ERGOTORQUEplus screwdriver for slotted screws, 4 mm, 180 mm	1
17	159.1006	ERGOTORQUEplus screwdriver for slotted screws, 5,5 mm, 230 mm	1
18	159.1009	ERGOTORQUEplus screwdriver for slotted screws, 6,5 mm, 255 mm	1
19	159.1011	ERGOTORQUEplus screwdriver for slotted screws, 8 mm, 315 mm	1
20	159.1029	ERGOTORQUEplus screwdriver, Torx, PH1, 205 mm	1
21	159.1022	ERGOTORQUEplus screwdriver, Torx, PH2, 230 mm	1
22	159.1024	ERGOTORQUEplus screwdriver, Torx, PH3, 265 mm	1
23	159.1141	ERGOTORQUEplus screwdriver for screws PH, PH1, stubby	1
24	159.1143	ERGOTORQUEplus screwdriver for screws PZ, PZ1, stubby	1
25	159.1040	ERGOTORQUEplus screwdriver for screws PZ, PZ1, 180 mm	1
26	159.1041	ERGOTORQUEplus screwdriver for screws PZ, PZ2, 205 mm	1
27	159.1044	ERGOTORQUEplus screwdriver for screws PZ, PZ3, 265 mm	1

811.1142

**M** 1/4" + 3/8" socket spanner set

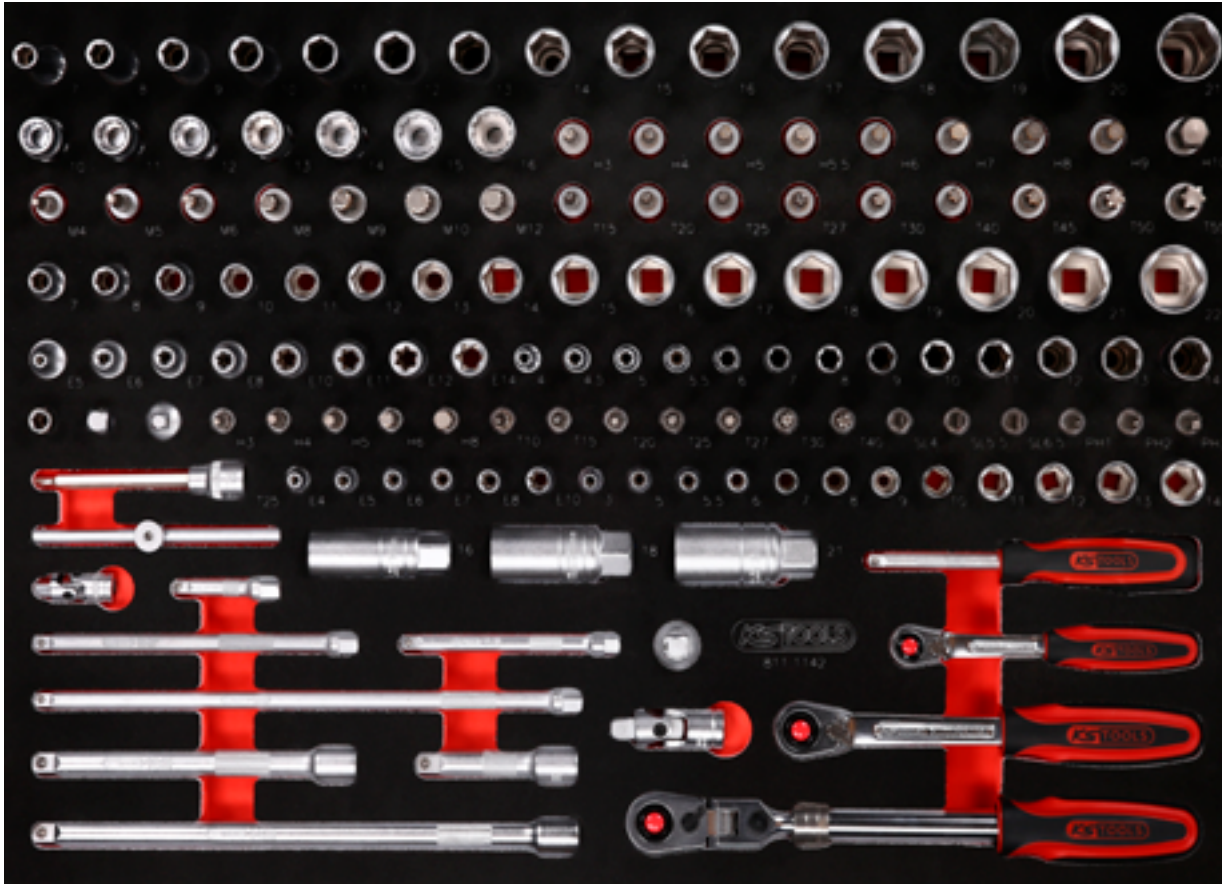

Pos.	Code	Description	pcs	Pos.	Code	Description	pcs	Pos.	Code	Description	pcs
1	917.4807	3/8" Hexagonal socket, deep, 7 mm	1	25	911.3865	3/8" Bit socket hexagon, 5 mm	1	49	917.3808	3/8" Hexagonal socket, 8 mm	1
2	917.3828	3/8" Hexagonal socket, deep, 8 mm	1	26	911.38655	3/8" Bit socket hexagon, 5,5 mm	1	50	917.3809	3/8" Hexagonal socket, 9 mm	1
3	917.3829	3/8" Hexagonal socket, deep, 9 mm	1	27	911.3866	3/8" Bit socket hexagon, 6 mm	1	51	917.3810	3/8" Hexagonal socket, 10 mm	1
4	917.3830	3/8" Hexagonal socket, deep, 10 mm	1	28	911.3867	3/8" Bit socket hexagon, 7 mm	1	52	917.3811	3/8" Hexagonal socket, 11 mm	1
5	917.3831	3/8" Hexagonal socket, deep, 11 mm	1	29	911.3868	3/8" Bit socket hexagon, 8 mm	1	53	917.3812	3/8" Hexagonal socket, 12 mm	1
6	917.3832	3/8" Hexagonal socket, deep, 12 mm	1	30	917.3969	3/8" Bit socket hexagon, 9 mm	1	54	917.3813	3/8" Hexagonal socket, 13 mm	1
7	917.3833	3/8" Hexagonal socket, deep, 13 mm	1	31	917.3857	3/8" Bit socket hexagon, 10 mm	1	55	917.3814	3/8" Hexagonal socket, 14 mm	1
8	917.3834	3/8" Hexagonal socket, deep, 14 mm	1	32	911.3918	3/8" Bit socket spline (XZN), M4	1	56	917.3815	3/8" Hexagonal socket, 15 mm	1
9	917.3835	3/8" Hexagonal socket, deep, 15 mm	1	33	911.3915	3/8" Bit socket spline (XZN), M5	1	57	917.3816	3/8" Hexagonal socket, 16 mm	1
10	917.3836	3/8" Hexagonal socket, deep, 16 mm	1	34	911.3916	3/8" Bit socket spline (XZN), M6	1	58	917.3817	3/8" Hexagonal socket, 17 mm	1
11	917.3837	3/8" Hexagonal socket, deep, 17 mm	1	35	911.3917	3/8" Bit socket spline (XZN), M8	1	59	917.3818	3/8" Hexagonal socket, 18 mm	1
12	917.3838	3/8" Hexagonal socket, deep, 18 mm	1	36	917.3901	3/8" Bit socket spline (XZN), M9	1	60	917.3819	3/8" Hexagonal socket, 19 mm	1
13	917.3839	3/8" Hexagonal socket, deep, 19 mm	1	37	911.3920	3/8" Bit socket spline (XZN), M10	1	61	917.3820	3/8" Hexagonal socket, 20 mm	1
14	917.3840	3/8" Hexagonal socket, deep, 20 mm	1	38	917.3903	3/8" Bit socket spline (XZN), M12	1	62	917.3821	3/8" Hexagonal socket, 21 mm	1
15	917.3841	3/8" Hexagonal socket, deep, 21 mm	1	39	911.3869	3/8" Bit socket Torx, T15	1	63	917.3822	3/8" Hexagonal socket, 22 mm	1
16	917.4851	3/8" 12-edge socket with joint, 10 mm	1	40	911.3870	3/8" Bit socket Torx, T20	1	64	911.4339	3/8" Torx E Socket, E5	1
17	917.4852	3/8" 12-edge socket with joint, 11 mm	1	41	911.3871	3/8" Bit socket Torx, T25	1	65	911.4340	3/8" Torx E Socket, E6	1
18	917.4853	3/8" 12-edge socket with joint, 12 mm	1	42	911.3872	3/8" Bit socket Torx, T27	1	66	911.4341	3/8" Torx E Socket, E7	1
19	917.4854	3/8" 12-edge socket with joint, 13 mm	1	43	911.3873	3/8" Bit socket Torx, T30	1	67	911.4342	3/8" Torx E Socket, E8	1
20	917.4855	3/8" 12-edge socket with joint, 14 mm	1	44	911.3874	3/8" Bit socket Torx, T40	1	68	911.4318	3/8" Torx E Socket, E10	1
21	917.4856	3/8" 12-edge socket with joint, 15 mm	1	45	911.3885	3/8" Bit socket Torx, T45	1	69	911.4319	3/8" Torx E Socket, E11	1
22	917.4857	3/8" 12-edge socket with joint, 16 mm	1	46	911.3884	3/8" Bit socket Torx, T50	1	70	911.4320	3/8" Torx E Socket, E12	1
23	911.3863	3/8" Bit socket hexagon, 3 mm	1	47	911.3888	3/8" Bit socket Torx, T55	1	71	911.4321	3/8" Torx E Socket, E14	1
24	911.3864	3/8" Bit socket hexagon, 4 mm	1	48	917.3807	3/8" Hexagonal socket, 7 mm	1	72	917.1448	1/4" Hexagonal socket, deep, 14 mm	1





811.0066

**M** 1/2" Socket spanner set



Pos.	Code	Description	pcs	Pos.	Code	Description	pcs	Pos.	Code	Description	pcs
1	911.1306	1/2" Bit socket hexagon, short, 6 mm	1	12	911.1363	1/2" Bit socket Torx, T27	1	23	911.4333	1/2" Torx E Socket, E10	1
2	911.1307	1/2" Bit socket hexagon, short, 7 mm	1	13	911.1364	1/2" Bit socket Torx, T30	1	24	911.4334	1/2" Torx E Socket, E11	1
3	911.1308	1/2" Bit socket hexagon, short, 8 mm	1	14	911.1365	1/2" Bit socket Torx, T40	1	25	911.4335	1/2" Torx E Socket, E12	1
4	911.1309	1/2" Bit socket hexagon, short, 9 mm	1	15	911.1366	1/2" Bit socket Torx, T45	1	26	911.4336	1/2" Torx E Socket, E14	1
5	911.1310	1/2" Bit socket hexagon, short, 10 mm	1	16	911.1367	1/2" Bit socket Torx, T50	1	27	911.4322	1/2" Torx E Socket, E16	1
6	911.1312	1/2" Bit socket hexagon, short, 12 mm	1	17	911.1368	1/2" Bit socket Torx, T55	1	28	911.4323	1/2" Torx E Socket, E18	1
7	911.1314	1/2" Bit socket hexagon, short, 14 mm	1	18	911.1369	1/2" Bit socket Torx, T60	1	29	911.4324	1/2" Torx E Socket, E20	1
8	911.1317	1/2" Bit socket hexagon, short, 17 mm	1	19	911.1374	1/2" Bit socket Torx tamperproof, TB30	1	30	911.4325	1/2" Torx E Socket, E22	1
9	911.1319	1/2" Bit socket hexagon, short, 19 mm	1	20	911.1375	1/2" Bit socket Torx tamperproof, TB40	1	31	911.4326	1/2" Torx E Socket, E24	1
10	911.1361	1/2" Bit socket Torx, T20	1	21	911.1376	1/2" Bit socket Torx tamperproof, TB45	1	32	911.3892	Adaptor, 3/8" Fx1/2" M	1
11	911.1362	1/2" Bit socket Torx, T25	1	22	911.1377	1/2" Bit socket Torx tamperproof, TB50	1	33	911.1233	Reducing adaptor, 1/2" F x 3/8" M	1





811.2041

**M** Screw spanner set

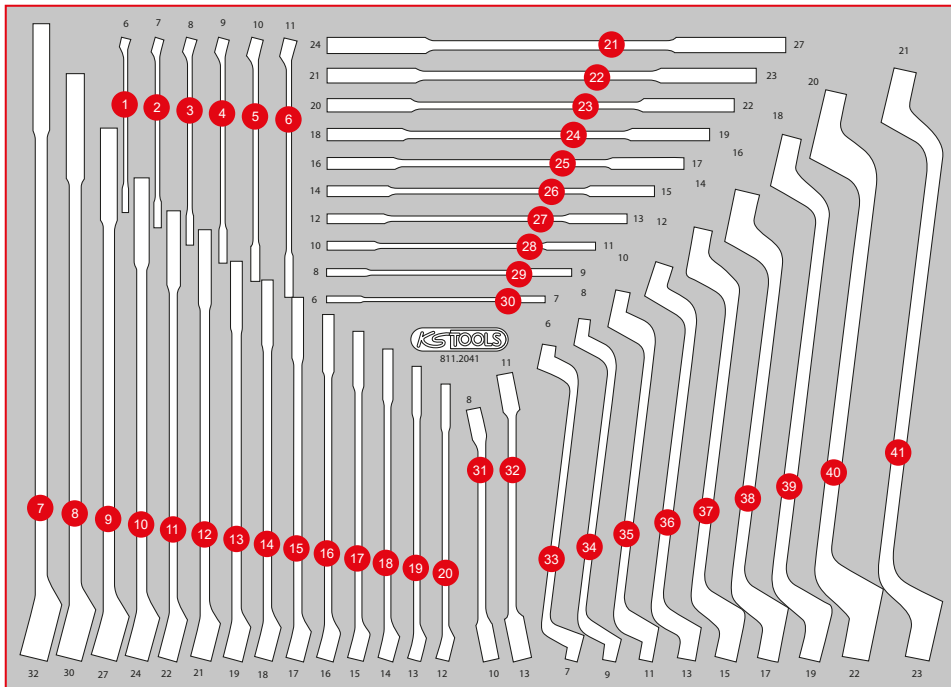

Pos.	Code	Description	pcs
1	517.0606	Combination spanners, offset, 6 mm	1
2	517.0607	Combination spanners, offset, 7 mm	1
3	517.0608	Combination spanners, offset, 8 mm	1
4	517.0609	Combination spanners, offset, 9 mm	1
5	517.0610	Combination spanners, offset, 10 mm	1
6	517.0611	Combination spanners, offset, 11 mm	1
7	517.0632	Combination spanners, offset, 32 mm	1
8	517.0630	Combination spanners, offset, 30 mm	1
9	517.0627	Combination spanners, offset, 27 mm	1
10	517.0624	Combination spanners, offset, 24 mm	1
11	517.0622	Combination spanners, offset, 22 mm	1
12	517.0621	Combination spanners, offset, 21 mm	1
13	517.0619	Combination spanners, offset, 19 mm	1
14	517.0618	Combination spanners, offset, 18 mm	1
15	517.0617	Combination spanners, offset, 17 mm	1
16	517.0616	Combination spanners, offset, 16 mm	1
17	517.0615	Combination spanners, offset, 15 mm	1
18	517.0614	Combination spanners, offset, 14 mm	1
19	517.0613	Combination spanners, offset, 13 mm	1
20	517.0612	Combination spanners, offset, 12 mm	1
21	517.0716	Double open ended spanners, 24 x 27 mm	1
22	517.0715	Double open ended spanners, 21 x 23 mm	1
23	517.0714	Double open ended spanners, 20 x 22 mm	1
24	517.0712	Double open ended spanners, 18 x 19 mm	1
25	517.0710	Double open ended spanners, 16 x 17 mm	1
26	517.0709	Double open ended spanners, 14 x 15 mm	1
27	517.0707	Double open ended spanners, 12 x 13 mm	1
28	517.0704	Double open ended spanners, 10 x 11 mm	1
29	517.0702	Double open ended spanners, 8 x 9 mm	1
30	517.0701	Double open ended spanners, 6 x 7 mm	1
31	517.0252	Open double ring spanner, offset, 8 x 10 mm	1
32	517.9244	Open double ring spanner, offset, 11 x 13 mm	1
33	517.0801	Double ring spanner, offset, 6 x 7 mm	1
34	517.0802	Double ring spanner, offset, 8 x 9 mm	1
35	517.0804	Double ring spanner, offset, 10 x 11 mm	1
36	517.0807	Double ring spanner, offset, 12 x 13 mm	1
37	517.0809	Double ring spanner, offset, 14 x 15 mm	1
38	517.0810	Double ring spanner, offset, 16 x 17 mm	1
39	517.0812	Double ring spanner, offset, 18 x 19 mm	1
40	517.0813	Double ring spanner, offset, 20 x 22 mm	1
41	517.0815	Double ring spanner, offset, 21 x 23 mm	1

811.0045

**M** Pliers and angle spanner set



Pos.	Code	Description	pcs
1	151.5210	Ball head Torx angled socket wrench set, extra long, 9 pcs	9
2	151.4420	Ball ended hexagon key wrench set, extra long, 9 pcs	9
3	115.1012	ERGOTORQUE diagonal side cutter, 160 mm	1
4	115.1021	ERGOTORQUE combination pliers, 180 mm	1
5	115.1024	ERGOTORQUE long nose pliers serrated cutter, 200 mm	1
6	907.2166	Snap off blades 0,5 x 18 x 100 mm, dispenser with 10 pieces	10
7	907.2135	Universal snap off blade knife 18 mm	1
8	115.1033	Self grip wrench, 220 mm	1
9	115.2010	Water pump pliers, 240 mm	1
10	500.1035	Circlip pliers for internal circlips, 160 mm	1
11	500.1032	Circlip pliers for internal circlips, angled, 160 mm	1
12	500.1029	Circlip pliers for external circlips, 160 mm	1
13	500.1026	Circlip pliers for external circlips, angled, 160 mm	1
14	151.2341	Torx key wrench, short, T6	1
15	151.2342	Torx key wrench, short, T7	1
16	151.2343	Torx key wrench, short, T8	1
17	151.2344	Torx key wrench, short, T9	1
18	550.1001	2in1 Telescopic solenoid holder with washer jet cleaning and setting tool, 150-675 mm	1
19	150.4370	perfectLight torch 85 lumen	1
20	550.1025	Flexible magnet lifter, 510 mm, Øhead=15 mm	1

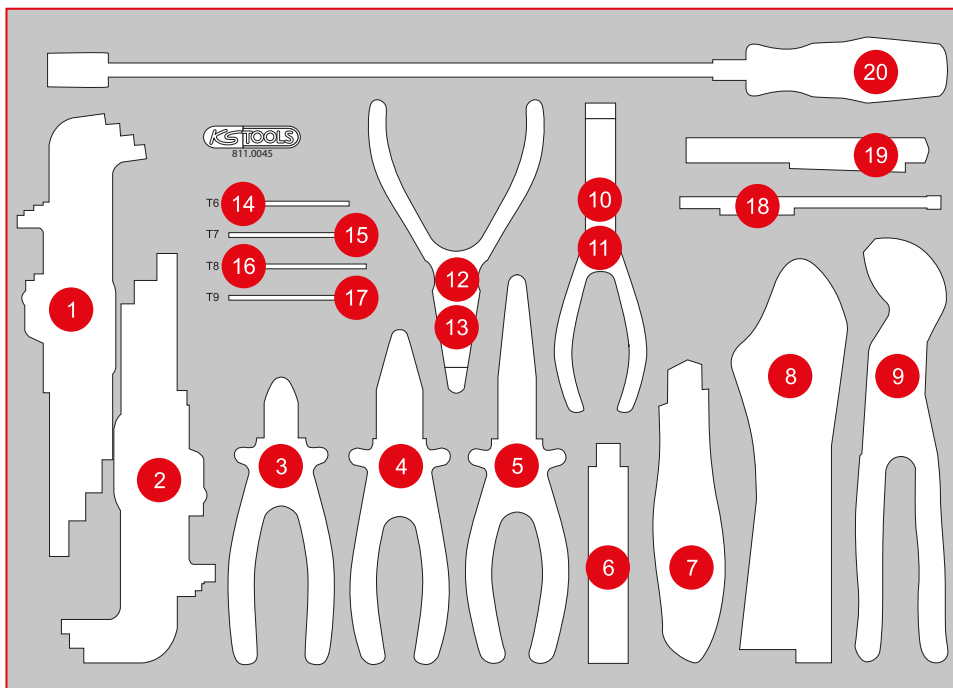



811.1017

**M** Hammer and chisel set

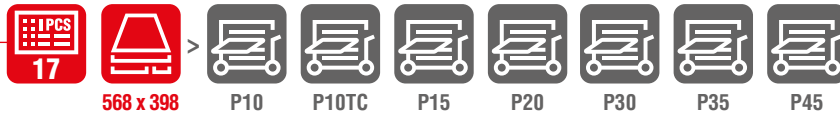

Pos.	Code	Description	pcs
1	150.1670	Test probe 6-24V DC with 5 m cable	1
2	911.8146	Tyre lever, 370 mm	1
3	156.0243	Centre punch, octagon 10 mm	1
4	156.0242	Cross chisel, octagon, 7 mm	1
5	156.0254	Flat chisel, octagon, 18 mm	1
6	156.0241	Flat chisel, octagon, 20 mm	1
7	156.0235	Pin punch, Ø 8 mm, cylindrical shaft	1
8	156.0234	Pin punch, Ø 6 mm, cylindrical shaft	1
9	156.0233	Pin punch, Ø 5 mm, cylindrical shaft	1
10	156.0232	Pin punch, Ø 4 mm, cylindrical shaft	1
11	156.0231	Pin punch, Ø 3 mm, cylindrical shaft	1
12	907.2222	Gasket scraper, 25 x 200 mm	1
13	201.2335	Steel wire brake saddle brush, 2-row, straight 225 mm	1
14	300.0114	Tape measure with locking device and belt clip, black red, 5 m, 19 mm	1
15	142.1402	Fitters Hammer, fiberglas handle, 400 g	1
16	140.5252	Recoil free soft faced Hammer, 400 g	1
17	911.8138	Trim plastic wedge, 195 x30 mm	1

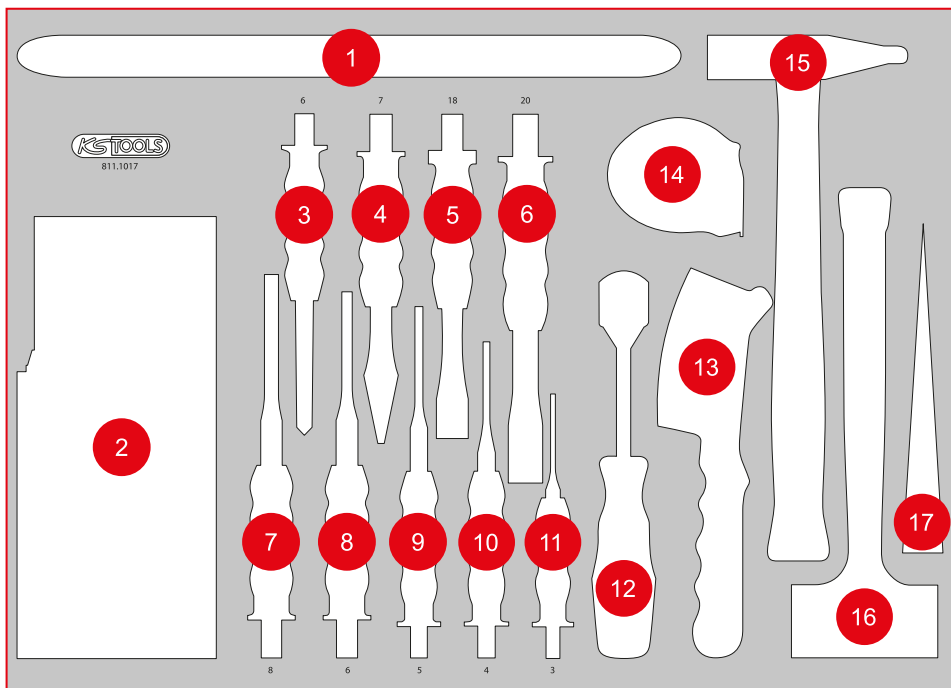

# P15

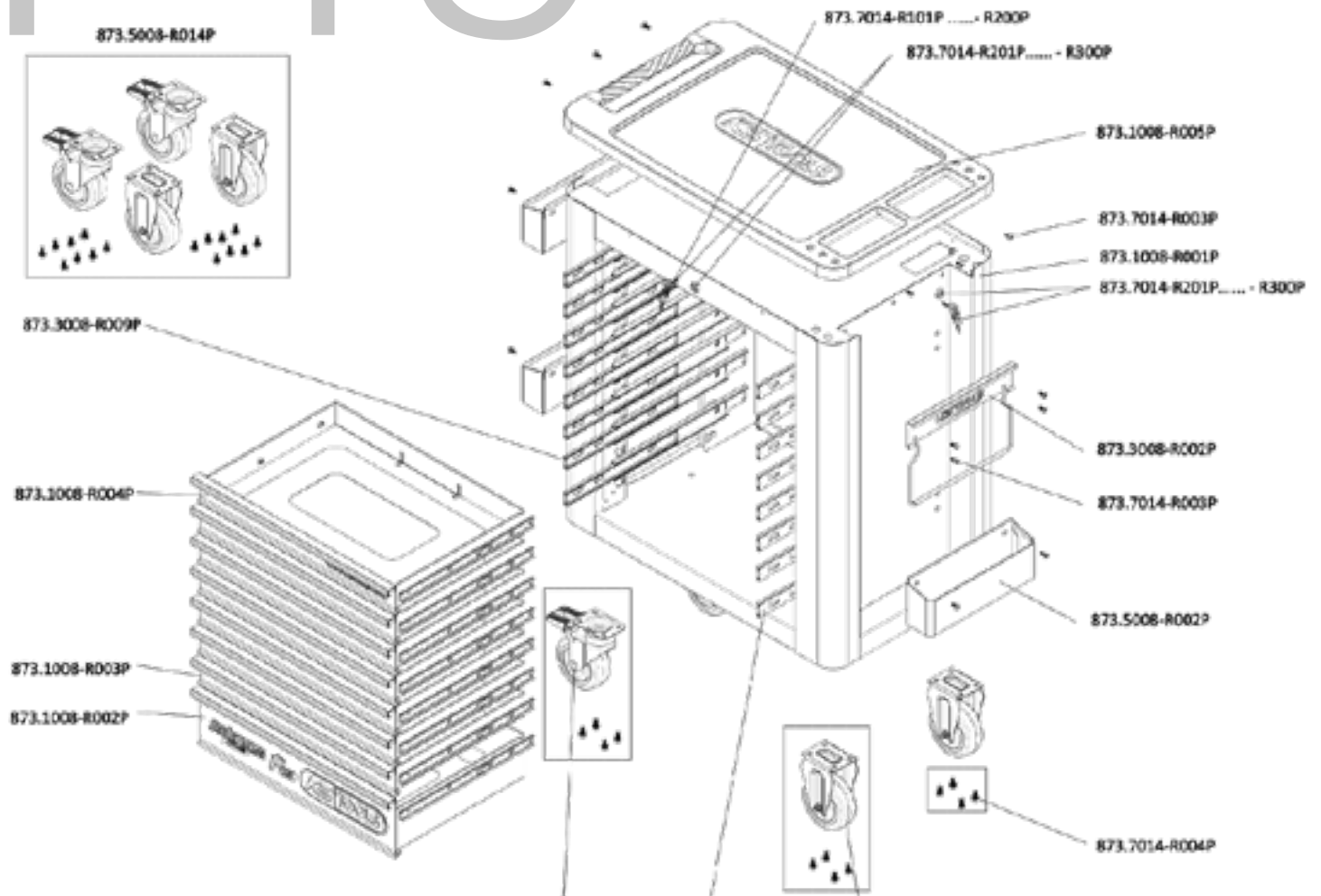

## INDIVIDUAL PARTS LIST

Art.-Nr.	Description	amount
873.7014-R101P...	Replacement key for PERFORMANCEplus workshop trolley lock number xyz	2
873.7014-R201P...	Lock with 2 keys for PERFORMANCEplus workshop trolley lock number xyz	2
873.1008-R001P	Body of workshop trolley	1
873.1008-R002P	Compartment with logo and ball-bearing guide, 568x398x145 mm	1
873.1008-R003P	Compartment with ball-bearing guide, for workshop trolley P10/P10TC/P15, 568x398x65 mm	6
873.1008-R004P	Compartment with website and ball-bearing guide, for workshop trolley P10/P15, 568x398x65 mm	1
873.1008-R005P	Plastic work surface with handle	1
873.3008-R002P	Paper roll holder for PERFORMANCEplus workshop trolley P10/P15/P25	1
873.3008-R008P	Full extension (with ball-bearing guide) with automatic retraction	8
873.3008-R009P	Full extension (with ball-bearing guide) with automatic retraction	8
873.5008-R002P	Can holder for PERFORMANCEplus workshop trolley P10/P15/P25/P35	3
873.5008-R009P	Fixed castors for PERFORMANCEplus workshop trolley, incl. screws	2
873.5008-R011P	Swivel castors with brakes, for PERFORMANCEplus workshop trolley, incl. screws	2
873.5008-R014P	Roller set for PERFORMANCEplus workshop trolley, incl. screws	1
873.7014-R003P	M6x12 screw (1 pcs.) for PERFORMANCEplus workshop trolley accessories	16
873.7014-R004P	M8 screws for PERFORMANCEplus workshop trolley rollers (16 pcs.)	1



**873.7014-R101P...R200P**  
Replacement key for lock number xyz



**873.7014-R201P...R300P**  
Lock with 2 keys, lock number xyz



**873.3008-R008P**  
Full extension (with ball-bearing guide) with automatic retraction, right



**873.3008-R009P**  
Full extension (with ball-bearing guide) with automatic retraction, left



**873.5008-R009P**  
Fixed castors, incl. screws

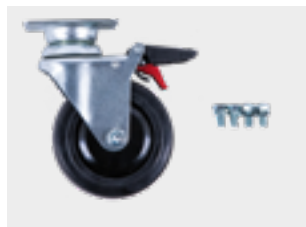

**873.5008-R011P**  
Swivel castors with brakes, incl. screws



**873.5008-R014P**  
Roller set, incl. screws



**873.1008-R005P**  
Plastic work surface with handle



**873.1008-R004P**  
Compartment with website and ball-bearing guide, 568x398x65 mm



**873.1008-R003P**  
Compartment with ball-bearing guide, 568x398x65 mm



**873.1008-R002P**  
Compartment with logo and ball-bearing guide, 568x398x145 mm



**873.5008-R002P**  
Can holder including screws, W = 310 mm



**873.3008-R002P**  
Paper roll holder including screws, W= 320 mm



**873.7014-R004P**  
M8 screws (16 pcs.)



**873.7014-R003P**  
M6x12 screw (1 pcs.)



**873.1008-R001P**  
Body of workshop trolley



The only thing that can't be replaced is the quality!