

**Heatsink**

**P 3**

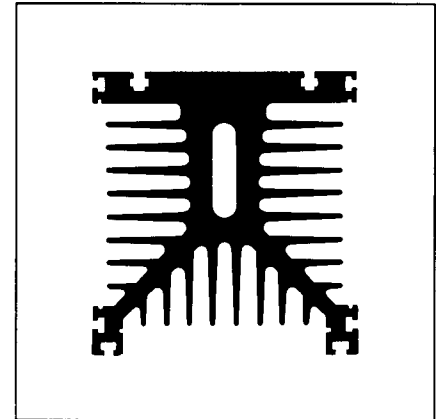

Standard lengths <sup>1)</sup>	n	b mm	R <sub>thha</sub> <sup>2)</sup> natural cooling °C/W	R <sub>thha</sub> <sup>3)</sup> forced air cooling °C/W	w kg
<b>P3/120</b>	1	20	0,55 (100 W)	0,167	2,1
	2		0,53 (100 W)	0,157	
	3		0,43 (150 W)	0,147	
<b>P3/180</b>	1	20	0,47 ( 70 W)	0,145	3,1
	2		0,39 (150 W)	0,132	
	3		0,36 (180 W)	0,120	
	6		0,33 (200 W)	0,108	
	1	34		0,144	3,1
	2			0,126	
	3			0,118	

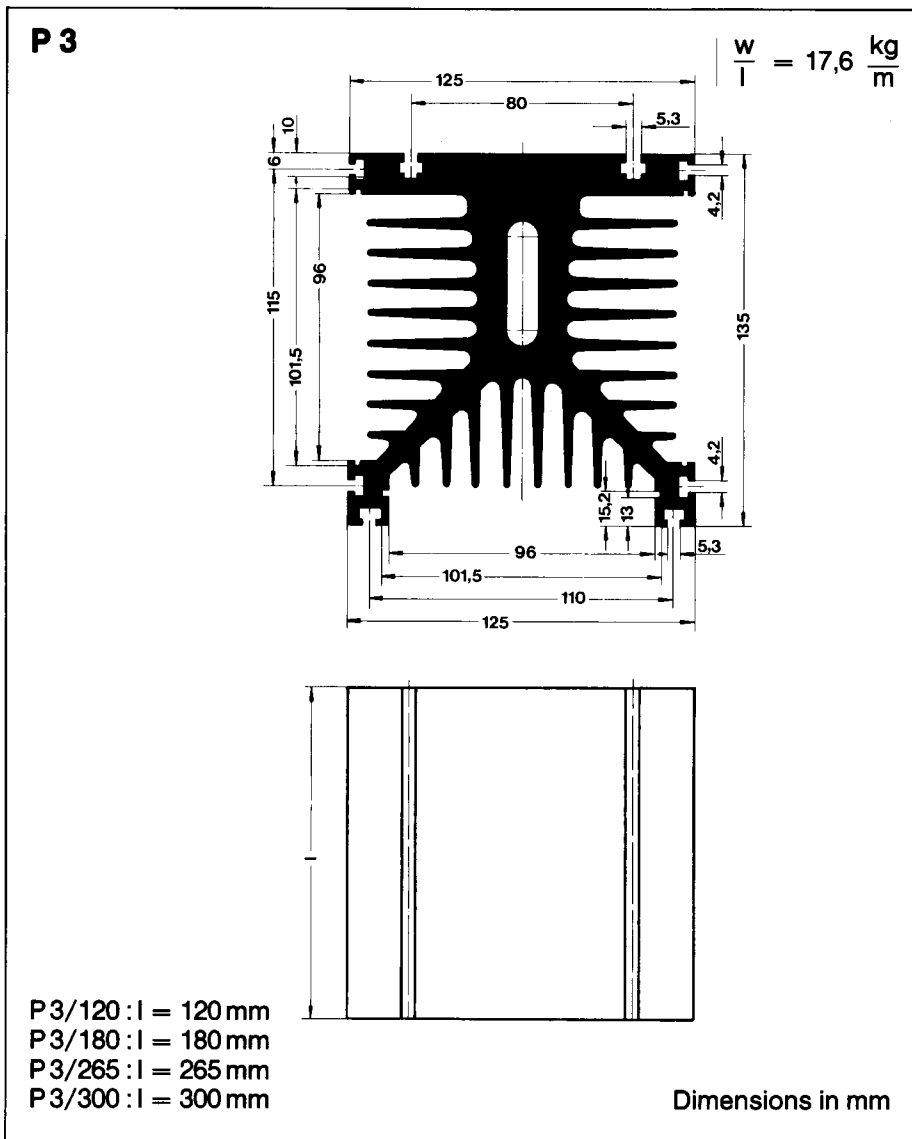

**Features**

- Intended for isolated power modules: the SEMIPACK and SEMITRANS ranges, and also for the SEMIPONT bridge rectifier range
- Available in various lengths
- Mounting channels are provided for the power modules as well as for additional accessories
- A suitable axial fan is available
- A large selection of mounting hardware is available

1) Non-standard lengths available on request  
 2) At the given power dissipation per semiconductor component  
 3) With fan type SKF 3-230-01 (see B14-109)

### P3/180F

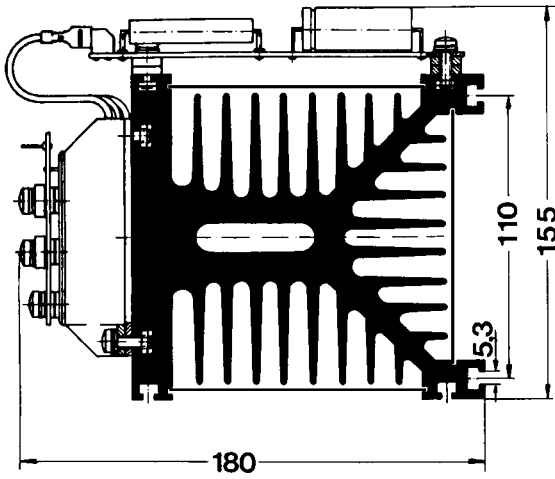

Dimensions in mm

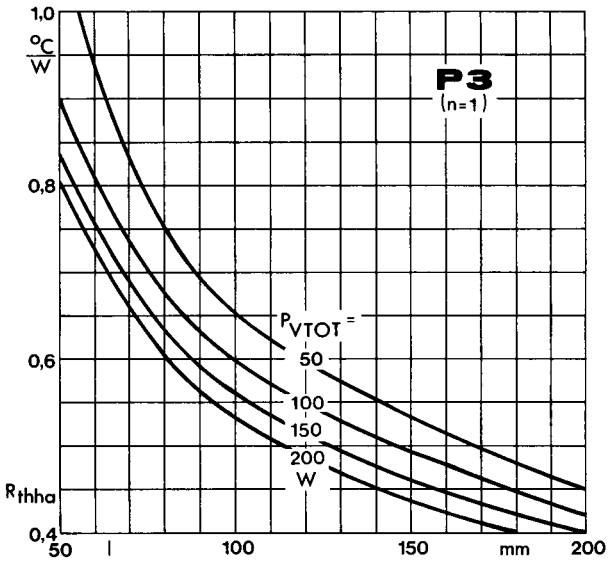
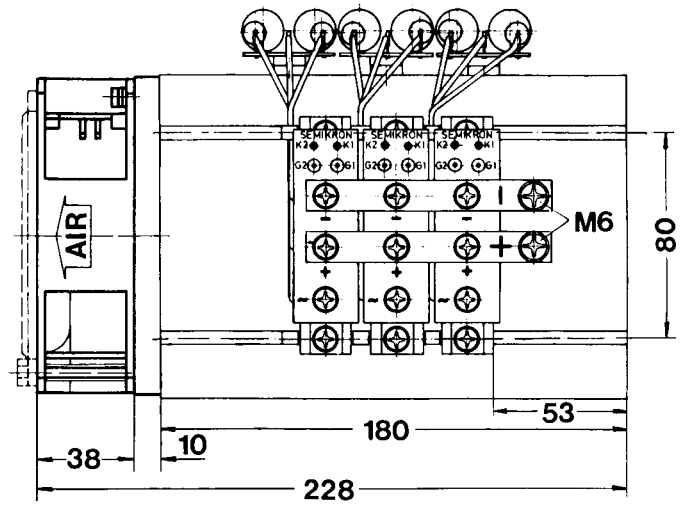

Fig. 3 a Total thermal resistance vs. length

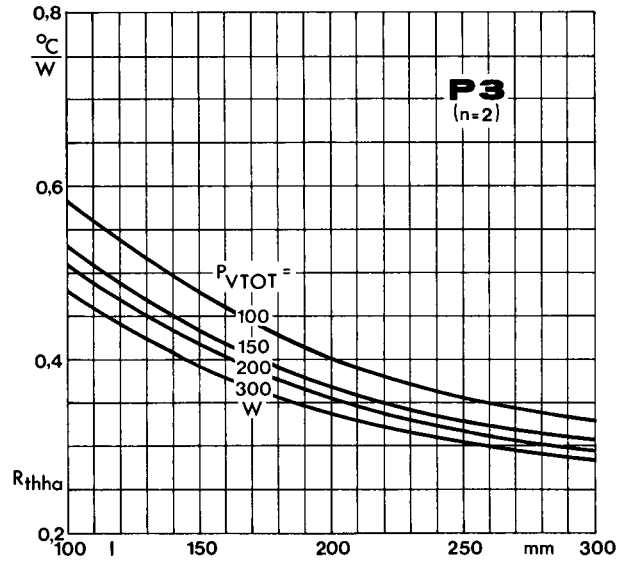

Fig. 3 b Total thermal resistance vs. length

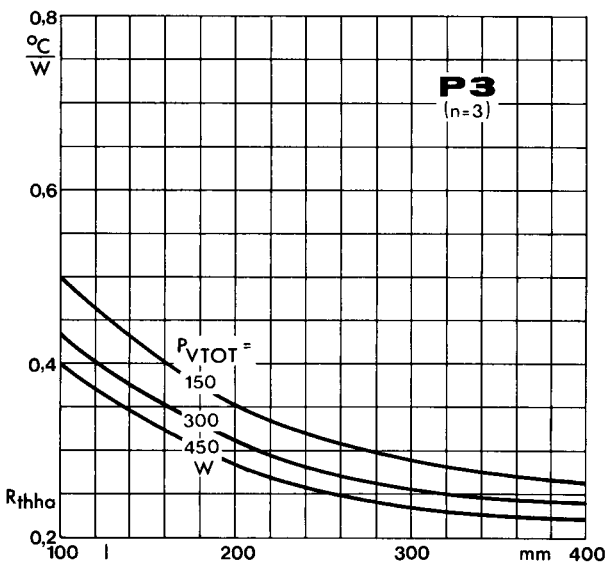

Fig. 3 c Total thermal resistance vs. length

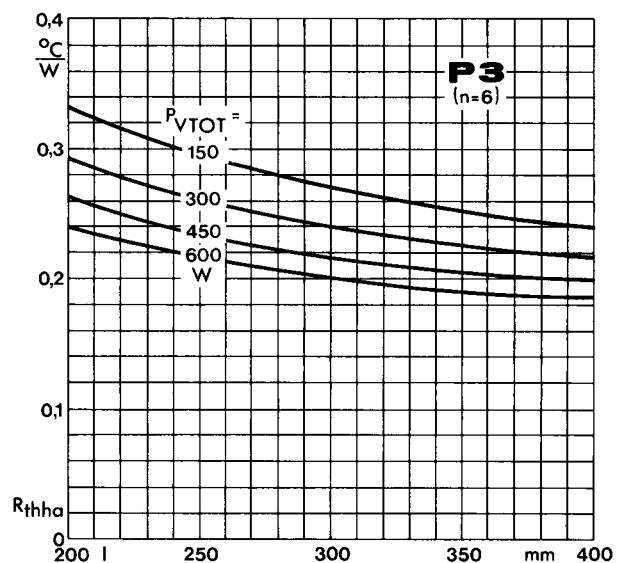

Fig. 3 d Total thermal resistance vs. length

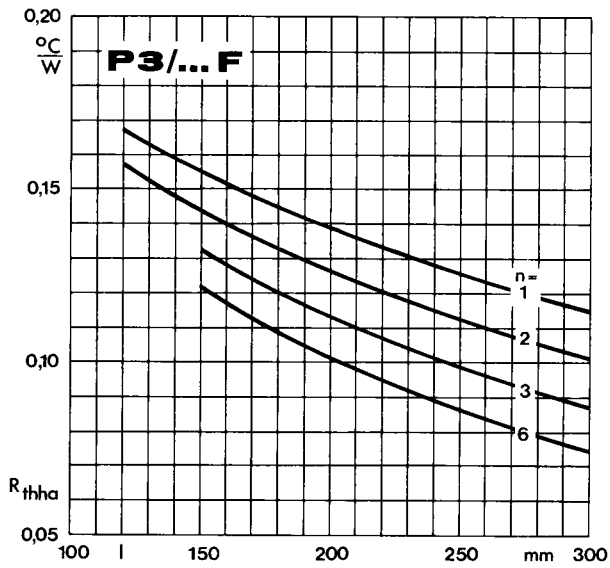

Fig. 6 Total thermal resistance vs. length

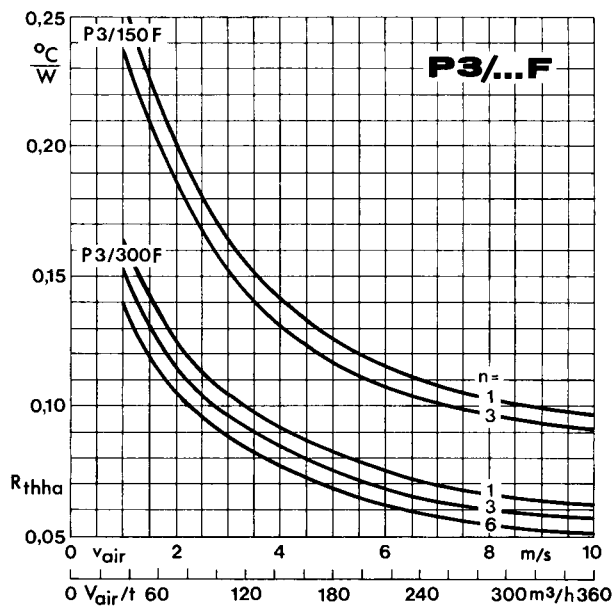

Fig. 7 Total thermal resistance vs. air flow

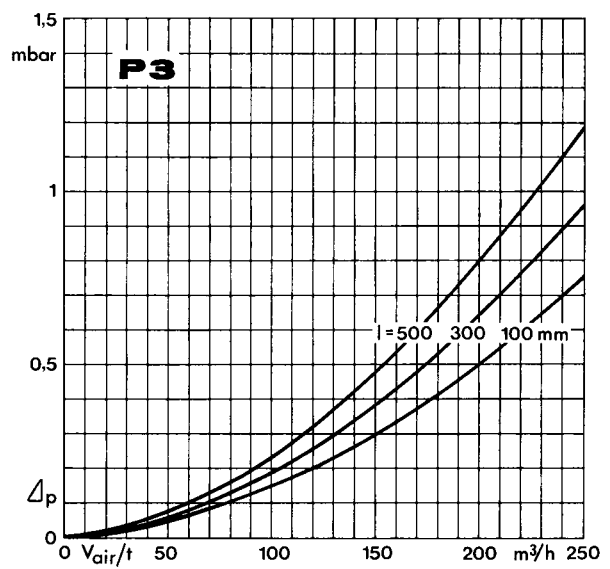

Fig. 8 Pressure drop vs. air flow

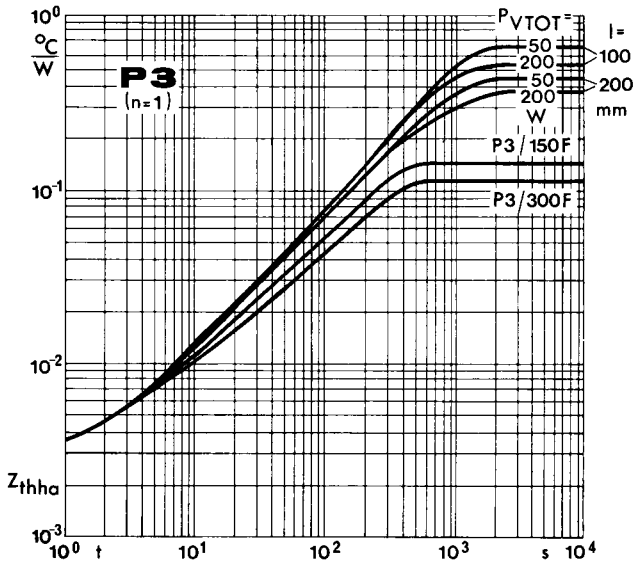

Fig. 10 a Total transient thermal impedance vs. time

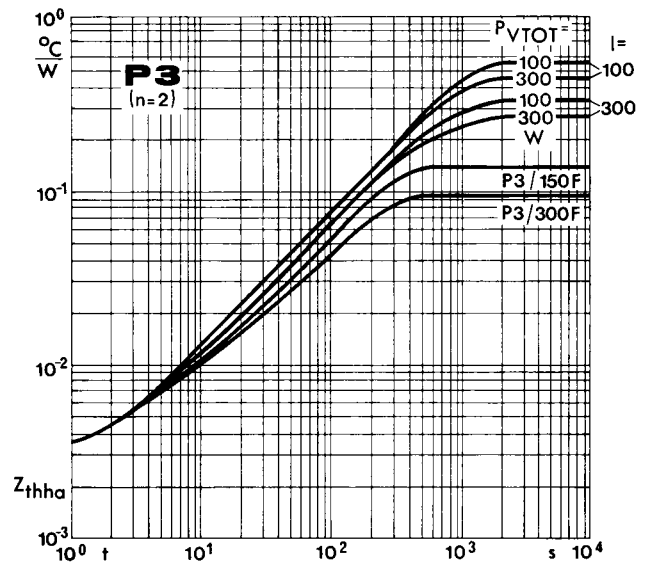

Fig. 10 b Total transient thermal impedance vs. time

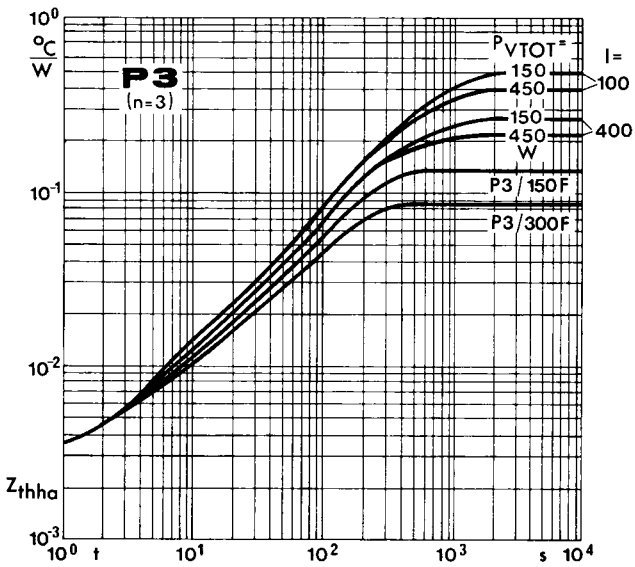

Fig. 10 c Total transient thermal impedance vs. time

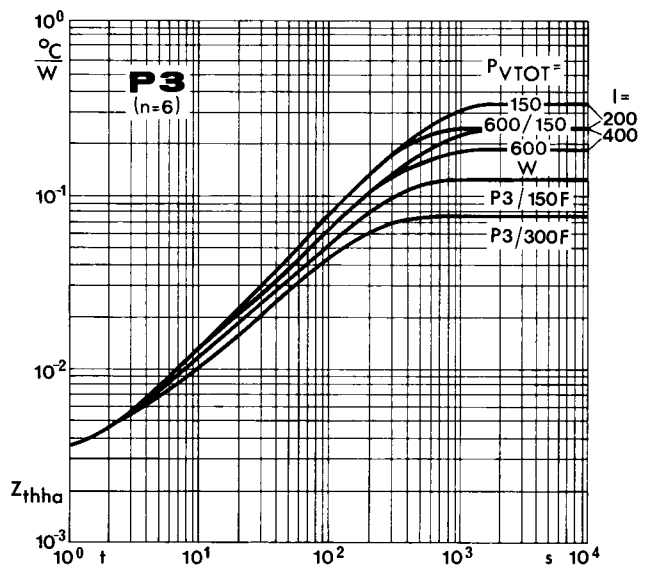

Fig. 10 d Total transient thermal impedance vs. time