

Number of contacts

8



## Features



- For an easy device integration
- Robust design
- 360° shielding
- Suitable for wave and reflow soldering (PSL R0 and MSL 1)
- Suitable for termination of massive and flexible wires
- Suitable for all PoE versions
- Very fast preLink® termination technology





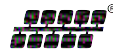

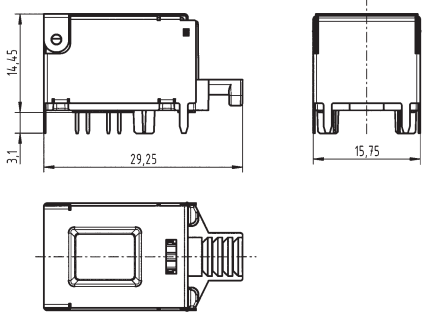
## Technical characteristics

Number of contacts	8
Limiting temperature	-40 ... +85 °C
Mating cycles	≥50
Degree of protection acc. to IEC 60529	IP20
Cable diameter	5 ... 9.5 mm
Transmission characteristics	Cat. 6 <sub>A</sub> , Class E <sub>A</sub> up to 500 MHz
Data rate	10 Mbit/s, 100 Mbit/s, 1 Gbit/s, 2.5 Gbit/s, 5 Gbit/s, 10 Gbit/s
Colour (insert)	Yellow, White, Black
Material (hood/housing)	Thermoplastic, Copper-zinc alloy
Surface (hood/housing)	Nickel plated
RoHS	compliant

## Specifications and approvals

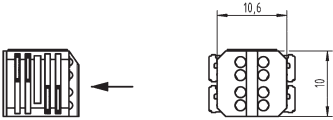

Identification	Part number	Drawing (dimensions in mm)
preLink®, PCB jack, THR, preLink® termination, Fully shielded, 360° shielding contact  Please order terminal module separately	20 82 007 1100	
preLink®, Terminal module, 8-pins, IDC insulation displacement termination, Conductor diameter 1.3 - 1.6 mm, AWG 23/22, IP20, Pack contents: Packaging unit: 10 pieces 	Yellow  20 82 000 0001	

Identification		Part number	Drawing (dimensions in mm)
<p>preLink®, Terminal module, 8-pins, IDC insulation displacement termination, Conductor diameter 0.8 - 1.1 mm, AWG 27/26, IP20, Pack contents: Packaging unit: 10 pieces</p> 	White	20 82 000 0003	
<p>preLink®, Terminal module, 4-pin, AIDA compliant, IDC insulation displacement termination, Conductor diameter 1.3 - 1.6 mm, AWG 23/22, IP20, Pack contents: Packaging unit: 10 pieces</p> 	Black	20 82 000 0005	 
<p>preLink®, Terminal module, 4-pin, AIDA compliant, IDC insulation displacement termination, Conductor diameter 1.3 - 1.6 mm, AWG 23/22, IP20, Pack contents: Packaging unit: 100 pieces</p> 	Black	20 82 000 0005 XL	
<p>Assembly tool, for preLink® terminal module</p>		20 82 000 9901	

Inter-  
face

Number of contacts

4



Circular

## Features

- Ethernet data connector suitable for industry
- Robust design
- 360° shielding
- Category of transmission Cat. 5
- Suitable for termination of massive and flexible wires
- Suitable for all PoE versions
- Very fast preLink® termination technology

## Technical characteristics

Number of contacts	4
Limiting temperature	-40 ... +85 °C
Mating cycles	≥50
Degree of protection acc. to IEC 60529	IP65, IP67
Cable diameter	5 ... 9.5 mm
Transmission characteristics	Cat. 5, Class D up to 100 MHz
Data rate	10 Mbit/s, 100 Mbit/s
Colour (insert)	Yellow, White, Black
Material (hood/housing)	Zinc die-cast
Surface (hood/housing)	Nickel plated
RoHS	compliant with exemption, compliant

## Specifications and approvals

IEC 61076-2-101

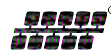

Identification

Part number

Drawing  
(dimensions in mm)

preLink®,  
M12,  
Cable jack set,  
IDC insulation displacement termination,  
Fully shielded, 360° shielding contact



Please order terminal module separately

20 82 005 2001

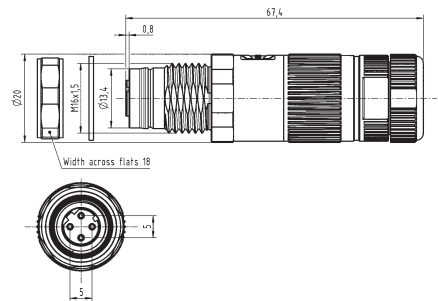







preLink®,  
Terminal module,  
8-pins,  
IDC insulation displacement termination,  
Conductor diameter 1.3 - 1.6 mm,  
AWG 23/22,  
IP20,  
Pack contents:  
Packaging unit: 10 pieces

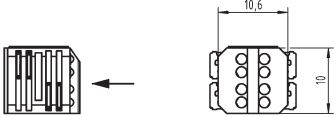

Yellow

20 82 000 0001

Circular

Identification		Part number	Drawing (dimensions in mm)
<p>preLink®, Terminal module, 8-pins, IDC insulation displacement termination, Conductor diameter 0.8 - 1.1 mm, AWG 27/26, IP20, Pack contents: Packaging unit: 10 pieces</p> 	<p>White</p>	<p>20 82 000 0003</p>	
<p>preLink®, Terminal module, 4-pin, AIDA compliant, IDC insulation displacement termination, Conductor diameter 1.3 - 1.6 mm, AWG 23/22, IP20, Pack contents: Packaging unit: 10 pieces</p> 	<p>Black</p>	<p>20 82 000 0005</p>	 
<p>preLink®, Terminal module, 4-pin, AIDA compliant, IDC insulation displacement termination, Conductor diameter 1.3 - 1.6 mm, AWG 23/22, IP20, Pack contents: Packaging unit: 100 pieces</p> 	<p>Black</p>	<p>20 82 000 0005 XL</p>	
<p>Assembly tool, for preLink® terminal module</p>		<p>20 82 000 9901</p>	

Number of contacts

8



Circular

## Features

- Ethernet data connector suitable for industry
- Robust design
- 360° shielding
- Category of transmission Cat. 6<sub>A</sub>
- Suitable for termination of massive and flexible wires
- Suitable for all PoE versions
- Very fast preLink® termination technology

## Technical characteristics

Number of contacts	8
Limiting temperature	-40 ... +85 °C
Mating cycles	≥50
Degree of protection acc. to IEC 60529	IP65, IP67
Cable diameter	5 ... 9.5 mm
Transmission characteristics	Cat. 6 <sub>A</sub> , Class E <sub>A</sub> up to 500 MHz
Data rate	10 Mbit/s, 100 Mbit/s, 1 Gbit/s, 2.5 Gbit/s, 5 Gbit/s, 10 Gbit/s
Colour (insert)	Yellow, White, Black
Material (hood/housing)	Zinc die-cast
Surface (hood/housing)	Nickel plated
RoHS	compliant with exemption, compliant

## Specifications and approvals

IEC 61076-2-109

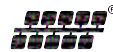

Identification	Part number	Drawing (dimensions in mm)
----------------	-------------	----------------------------

preLink®,  
M12,  
Cable jack set,  
IDC insulation displacement termination,  
Fully shielded, 360° shielding contact



Please order terminal module separately

20 82 006 2001

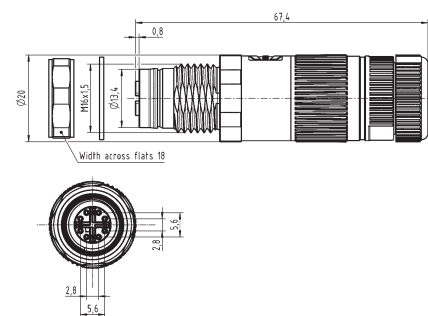





preLink®,  
Terminal module,  
8-pins,  
IDC insulation displacement termination,  
Conductor diameter 1.3 - 1.6 mm,  
AWG 23/22,  
IP20,  
Pack contents:  
Packaging unit: 10 pieces



Yellow

20 82 000 0001

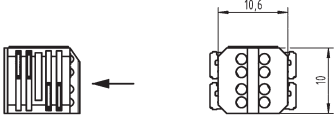
Circular

Identification		Part number	Drawing (dimensions in mm)
<p>preLink®, Terminal module, 8-pins, IDC insulation displacement termination, Conductor diameter 0.8 - 1.1 mm, AWG 27/26, IP20, Pack contents: Packaging unit: 10 pieces</p> 	<p>White</p>	<p>20 82 000 0003</p>	
<p>preLink®, Terminal module, 4-pin, AIDA compliant, IDC insulation displacement termination, Conductor diameter 1.3 - 1.6 mm, AWG 23/22, IP20, Pack contents: Packaging unit: 10 pieces</p> 	<p>Black</p>	<p>20 82 000 0005</p>	 
<p>preLink®, Terminal module, 4-pin, AIDA compliant, IDC insulation displacement termination, Conductor diameter 1.3 - 1.6 mm, AWG 23/22, IP20, Pack contents: Packaging unit: 100 pieces</p> 	<p>Black</p>	<p>20 82 000 0005 XL</p>	
<p>Assembly tool, for preLink® terminal module</p>		<p>20 82 000 9901</p>	