



ON Semiconductor®

# FDBL86563-F085

## N-Channel PowerTrench® MOSFET

60 V, 240 A, 1.5 mΩ

### Features

- Typical  $R_{DS(on)}$  = 1.1 mΩ at  $V_{GS} = 10V$ ,  $I_D = 80 A$
- Typical  $Q_{g(tot)}$  = 130 nC at  $V_{GS} = 10V$ ,  $I_D = 80 A$
- UIS Capability
- RoHS Compliant
- Qualified to AEC Q101

### Applications

- Automotive Engine Control
- PowerTrain Management
- Solenoid and Motor Drivers
- Integrated Starter/Alternator
- Primary Switch for 12V Systems

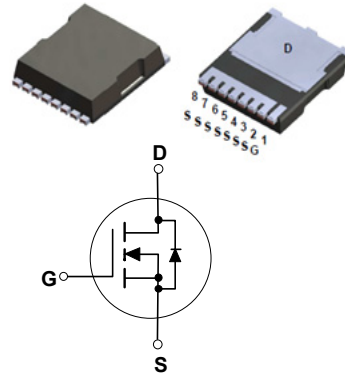

**MOSFET Maximum Ratings**  $T_J = 25^\circ C$  unless otherwise noted.

Symbol	Parameter	Ratings	Units
$V_{DSS}$	Drain-to-Source Voltage	60	V
$V_{GS}$	Gate-to-Source Voltage	±20	V
$I_D$	Drain Current - Continuous ( $V_{GS}=10$ ) (Note 1)	$T_C = 25^\circ C$	A
	Pulsed Drain Current	$T_C = 25^\circ C$	
$E_{AS}$	Single Pulse Avalanche Energy (Note 2)	614	mJ
$P_D$	Power Dissipation	357	W
	Derate Above $25^\circ C$	2.38	W/ $^\circ C$
$T_J, T_{STG}$	Operating and Storage Temperature	-55 to + 175	$^\circ C$
$R_{\theta JC}$	Thermal Resistance, Junction to Case	0.42	$^\circ C/W$
$R_{\theta JA}$	Maximum Thermal Resistance, Junction to Ambient (Note 3)	43	$^\circ C/W$

#### Notes:

- 1: Current is limited by silicon.
- 2: Starting  $T_J = 25^\circ C$ ,  $L = 0.3mH$ ,  $I_{AS} = 64A$ ,  $V_{DD} = 60V$  during inductor charging and  $V_{DD} = 0V$  during time in avalanche.
- 3:  $R_{\theta JA}$  is the sum of the junction-to-case and case-to-ambient thermal resistance, where the case thermal reference is defined as the solder mounting surface of the drain pins.  $R_{\theta JC}$  is guaranteed by design, while  $R_{\theta JA}$  is determined by the board design. The maximum rating presented here is based on mounting on a 1 in<sup>2</sup> pad of 2oz copper.

### Package Marking and Ordering Information

Device Marking	Device	Package	Reel Size	Tape Width	Quantity
FDBL86563	FDBL86563-F085	MO-299A	13"	24mm	2000 units

FDBL86563-F085 N-Channel PowerTrench® MOSFET

## Electrical Characteristics $T_J = 25^\circ\text{C}$ unless otherwise noted.

Symbol	Parameter	Test Conditions	Min.	Typ.	Max.	Units
--------	-----------	-----------------	------	------	------	-------

### Off Characteristics

$B_{V_{DS}}$	Drain-to-Source Breakdown Voltage	$I_D = 250\mu\text{A}$ , $V_{GS} = 0\text{V}$	60	-	-	V
$I_{DSS}$	Drain-to-Source Leakage Current	$V_{DS} = 60\text{V}$ , $T_J = 25^\circ\text{C}$	-	-	1	$\mu\text{A}$
		$V_{GS} = 0\text{V}$ , $T_J = 175^\circ\text{C}$ (Note 4)	-	-	1	mA
$I_{GSS}$	Gate-to-Source Leakage Current	$V_{GS} = \pm 20\text{V}$	-	-	$\pm 100$	nA

### On Characteristics

$V_{GS(th)}$	Gate to Source Threshold Voltage	$V_{GS} = V_{DS}$ , $I_D = 250\mu\text{A}$	2.0	2.9	4.0	V
$R_{DS(on)}$	Drain to Source On Resistance	$I_D = 80\text{A}$ , $T_J = 25^\circ\text{C}$	-	1.1	1.5	m $\Omega$
		$V_{GS} = 10\text{V}$ , $T_J = 175^\circ\text{C}$ (Note 4)	-	2.1	2.9	m $\Omega$

### Dynamic Characteristics

$C_{iss}$	Input Capacitance	$V_{DS} = 30\text{V}$ , $V_{GS} = 0\text{V}$ , $f = 1\text{MHz}$	-	10300	-	pF
$C_{oss}$	Output Capacitance		-	2590	-	pF
$C_{rss}$	Reverse Transfer Capacitance		-	270	-	pF
$R_g$	Gate Resistance	$f = 1\text{MHz}$	-	4.3	-	$\Omega$
$Q_{g(ToT)}$	Total Gate Charge at 10V	$V_{GS} = 0$ to 10V	-	130	169	nC
$Q_{g(th)}$	Threshold Gate Charge	$V_{GS} = 0$ to 2V				
$Q_{gs}$	Gate-to-Source Gate Charge	$V_{DD} = 48\text{V}$ $I_D = 80\text{A}$	-	48	-	nC
$Q_{gd}$	Gate-to-Drain "Miller" Charge		-	20	-	nC

### Switching Characteristics

$t_{on}$	Turn-On Time	$V_{DD} = 30\text{V}$ , $I_D = 80\text{A}$ , $V_{GS} = 10\text{V}$ , $R_{GEN} = 6\Omega$	-	-	160	ns
$t_{d(on)}$	Turn-On Delay		-	30	-	ns
$t_r$	Rise Time		-	77	-	ns
$t_{d(off)}$	Turn-Off Delay		-	78	-	ns
$t_f$	Fall Time		-	57	-	ns
$t_{off}$	Turn-Off Time		-	-	200	ns

### Drain-Source Diode Characteristics

$V_{SD}$	Source-to-Drain Diode Voltage	$I_{SD} = 80\text{A}$ , $V_{GS} = 0\text{V}$	-	-	1.25	V
		$I_{SD} = 40\text{A}$ , $V_{GS} = 0\text{V}$	-	-	1.2	V
$t_{rr}$	Reverse-Recovery Time	$I_F = 80\text{A}$ , $dI_{SD}/dt = 100\text{A}/\mu\text{s}$	-	94	140	ns
$Q_{rr}$	Reverse-Recovery Charge	$V_{DD} = 48\text{V}$	-	131	200	nC

**Note:**

4: The maximum value is specified by design at  $T_J = 175^\circ\text{C}$ . Product is not tested to this condition in production.

### Typical Characteristics

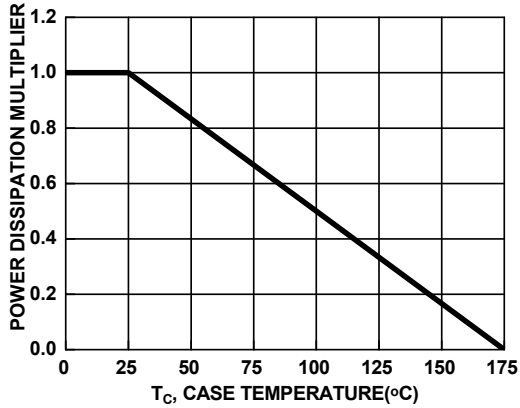

Figure 1. Normalized Power Dissipation vs. Case Temperature

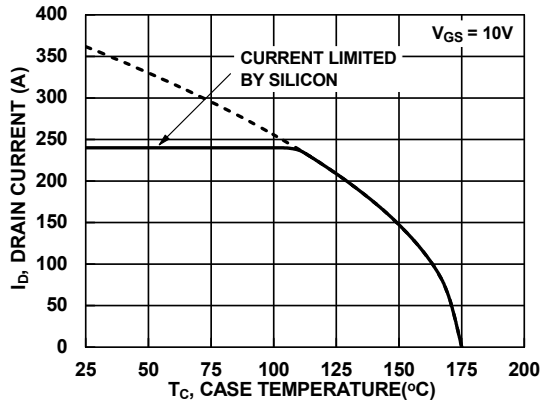

Figure 2. Maximum Continuous Drain Current vs. Case Temperature

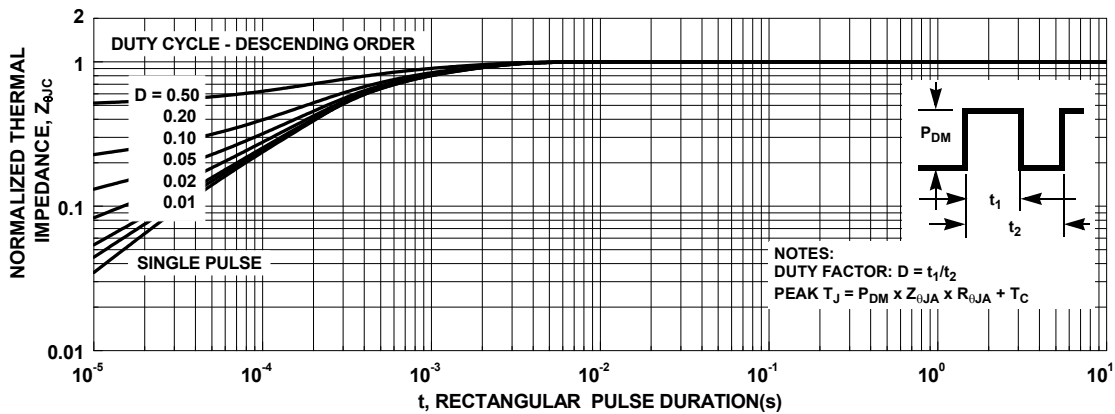

Figure 3. Normalized Maximum Transient Thermal Impedance

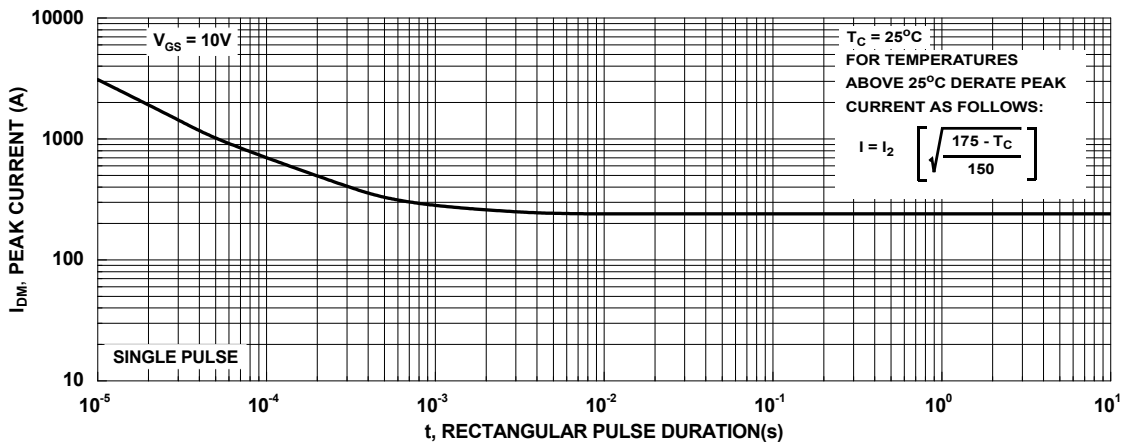

Figure 4. Peak Current Capability

## Typical Characteristics

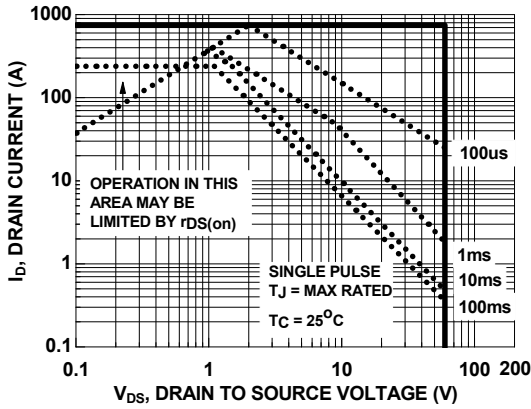
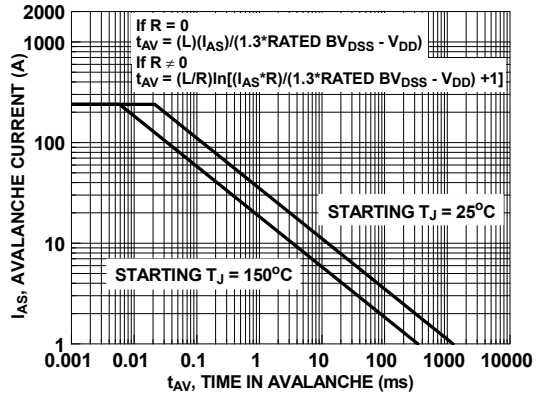

Figure 5. Forward Bias Safe Operating Area



NOTE: Refer to ON Semiconductor Application Notes AN7514 and AN7515

Figure 6. Unclamped Inductive Switching Capability

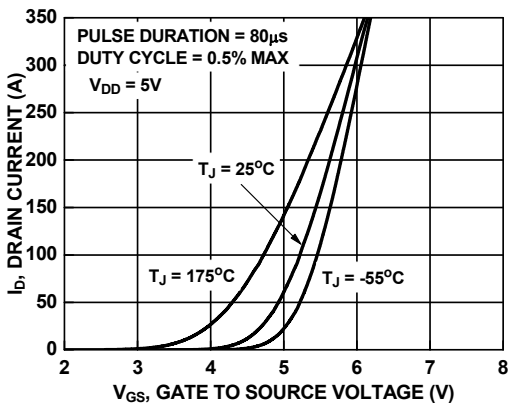

Figure 7. Transfer Characteristics

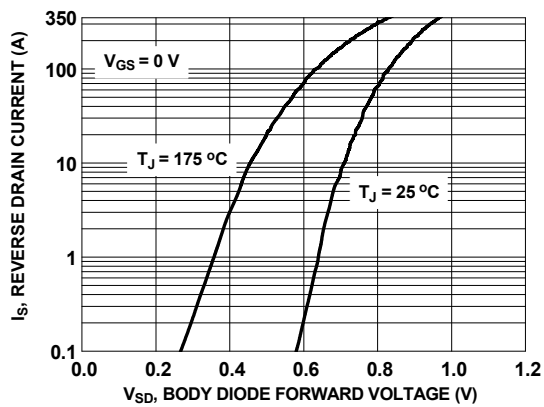

Figure 8. Forward Diode Characteristics

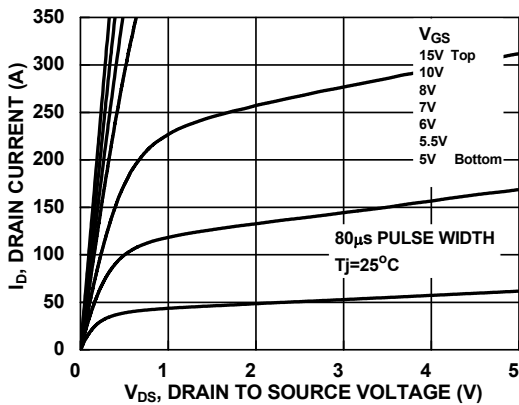

Figure 9. Saturation Characteristics

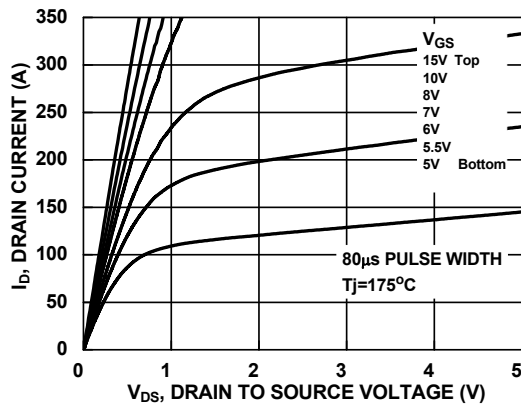

Figure 10. Saturation Characteristics

### Typical Characteristics

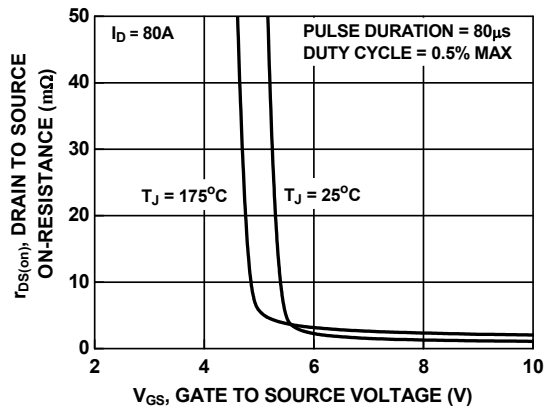

Figure 11.  $R_{DS(on)}$  vs. Gate Voltage

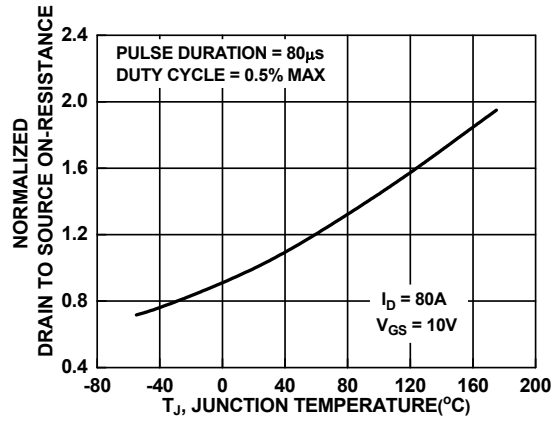

Figure 12. Normalized  $R_{DS(on)}$  vs. Junction Temperature

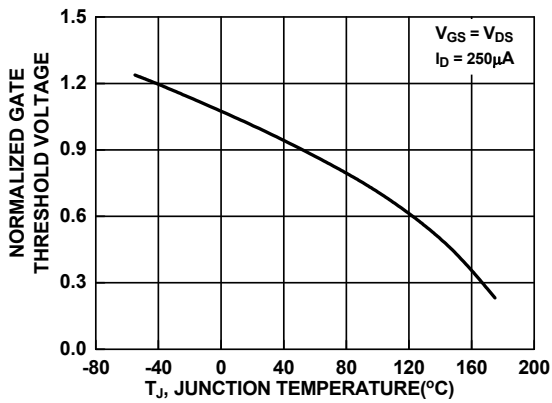

Figure 13. Normalized Gate Threshold Voltage vs. Temperature

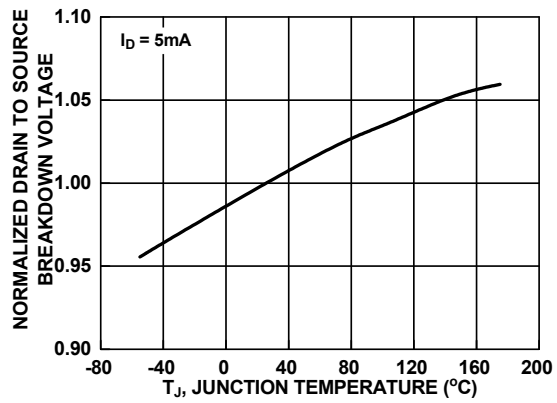

Figure 14. Normalized Drain to Source Breakdown Voltage vs. Junction Temperature

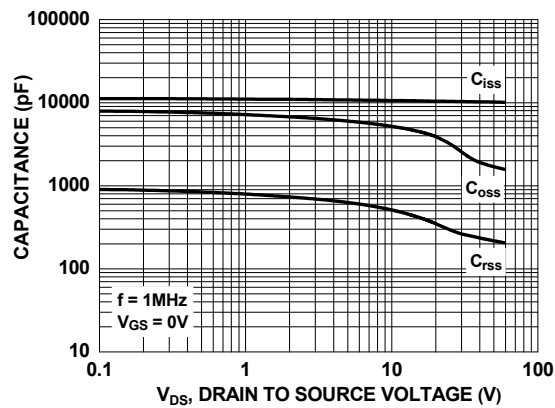

Figure 15. Capacitance vs. Drain to Source Voltage

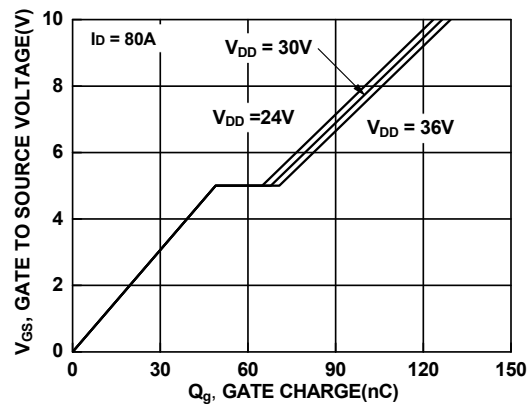

Figure 16. Gate Charge vs. Gate to Source Voltage

ON Semiconductor and  are trademarks of Semiconductor Components Industries, LLC dba ON Semiconductor or its subsidiaries in the United States and/or other countries. ON Semiconductor owns the rights to a number of patents, trademarks, copyrights, trade secrets, and other intellectual property. A listing of ON Semiconductor's product/patent coverage may be accessed at [www.onsemi.com/site/pdf/Patent-Marking.pdf](http://www.onsemi.com/site/pdf/Patent-Marking.pdf). ON Semiconductor reserves the right to make changes without further notice to any products herein. ON Semiconductor makes no warranty, representation or guarantee regarding the suitability of its products for any particular purpose, nor does ON Semiconductor assume any liability arising out of the application or use of any product or circuit, and specifically disclaims any and all liability, including without limitation special, consequential or incidental damages. Buyer is responsible for its products and applications using ON Semiconductor products, including compliance with all laws, regulations and safety requirements or standards, regardless of any support or applications information provided by ON Semiconductor. "Typical" parameters which may be provided in ON Semiconductor data sheets and/or specifications can and do vary in different applications and actual performance may vary over time. All operating parameters, including "Typicals" must be validated for each customer application by customer's technical experts. ON Semiconductor does not convey any license under its patent rights nor the rights of others. ON Semiconductor products are not designed, intended, or authorized for use as a critical component in life support systems or any FDA Class 3 medical devices or medical devices with a same or similar classification in a foreign jurisdiction or any devices intended for implantation in the human body. Should Buyer purchase or use ON Semiconductor products for any such unintended or unauthorized application, Buyer shall indemnify and hold ON Semiconductor and its officers, employees, subsidiaries, affiliates, and distributors harmless against all claims, costs, damages, and expenses, and reasonable attorney fees arising out of, directly or indirectly, any claim of personal injury or death associated with such unintended or unauthorized use, even if such claim alleges that ON Semiconductor was negligent regarding the design or manufacture of the part. ON Semiconductor is an Equal Opportunity/Affirmative Action Employer. This literature is subject to all applicable copyright laws and is not for resale in any manner.

## PUBLICATION ORDERING INFORMATION

### LITERATURE FULFILLMENT:

Literature Distribution Center for ON Semiconductor  
19521 E. 32nd Pkwy, Aurora, Colorado 80011 USA  
**Phone:** 303-675-2175 or 800-344-3860 Toll Free USA/Canada  
**Fax:** 303-675-2176 or 800-344-3867 Toll Free USA/Canada  
**Email:** [orderlit@onsemi.com](mailto:orderlit@onsemi.com)

**N. American Technical Support:** 800-282-9855 Toll Free  
USA/Canada  
**Europe, Middle East and Africa Technical Support:**  
Phone: 421 33 790 2910  
**Japan Customer Focus Center**  
Phone: 81-3-5817-1050

**ON Semiconductor Website:** [www.onsemi.com](http://www.onsemi.com)  
**Order Literature:** <http://www.onsemi.com/orderlit>  
For additional information, please contact your local  
Sales Representative