

PT/451 Products

Subminiature cylindrical connectors
Connecteurs circulaires subminiatures

MIL-DTL-26482 Series I
HE301 - VG95328





MAIN CHARACTERISTICS

| | |
|-------------------------------|---|
| Presentation | 4 |
| Applications | 4 |
| General Characteristics | 5 |

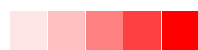

TECHNICAL CHARACTERISTICS

| | |
|---|---|
| PT/451 mated connectors cross section | 6 |
| Mechanical characteristics | 7 |
| Environmental characteristics | 7 |
| Electrical characteristics | 8 |
| Contact dimensions and wire sizes | 8 |
| Coding system / Alternate insert position | 9 |



CONNECTORS ORDERING INFORMATION

| | |
|--|----|
| Insert arrangements | 10 |
| Shells and backshells, possible combinations | 12 |
| How to order | 14 |
| Cross references chart | 18 |



OVERALL DIMENSIONS

| | |
|---|----|
| Square flange receptacles 02 type | 20 |
| Square flange receptacles 00 type | 20 |
| Inline receptacles 01 type | 24 |
| Jam nut receptacles 07 type | 28 |
| Plugs 06, G06, 08 types | 31 |
| Receptacle with locking ring 09 type | 38 |
| Receptacles with PCB and wire wrap contacts | 38 |
| Hermetic receptacles | 40 |
| Through bulkhead receptacle PTB type | 41 |
| Connectors to order without backshell | 42 |
| Custom design | 44 |



RUGGED RJ45 SOLUTIONS

49

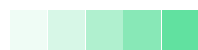

ACCESSORIES

| | |
|--|----|
| Protective caps | 60 |
| Snap caps | 62 |
| Contacts and sealing plugs | 64 |
| Dummy receptacle, panel gasket, plastic dust cap | 64 |
| Heatshrink moulded piece for rear accessory | 65 |

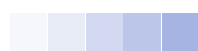

INSTALLATION - IMPLEMENTATION

| | |
|-----------------------------|----|
| Panel drilling | 66 |
| Panel thickness | 66 |
| Coupling torque value | 66 |
| PCB drillings | 67 |

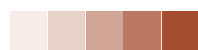

CRIMPING OPERATIONS

| | |
|-----------------|----|
| Tools | 70 |
| Procedure | 71 |



PRINCIPALES CARACTÉRISTIQUES

| | |
|---------------------------------|---|
| Présentation..... | 4 |
| Applications..... | 4 |
| Caractéristiques générales..... | 5 |

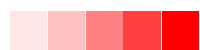

CARACTÉRISTIQUES TECHNIQUES

| | |
|---|---|
| Coupe de connecteurs PT/451 assemblés..... | 6 |
| Caractéristiques mécaniques..... | 7 |
| Caractéristiques environnementales..... | 7 |
| Caractéristiques électriques..... | 8 |
| Dimensions des contacts et tailles des conducteurs..... | 8 |
| Système de codage / Orientation de l'isolant..... | 9 |



INFORMATIONS POUR DÉFINIR VOS REFERENCES

| | |
|---|----|
| Arrangements de contacts..... | 10 |
| Boîtiers et raccords, combinaisons possibles..... | 12 |
| Comment commander..... | 14 |
| Tableaux d'équivalences..... | 18 |



DIMENSIONS GÉNÉRALES

| | |
|--|----|
| Embases carrées type 02..... | 20 |
| Embases carrées type 00..... | 20 |
| Prolongateurs type 01..... | 24 |
| Embases à écrou type 07..... | 28 |
| Fiches types 06, G06, 08..... | 31 |
| Embase à écrou type 09..... | 38 |
| Embases avec contacts à piquer et à wrapper..... | 38 |
| Embases hermétiques..... | 40 |
| Embase traversée de cloison type PTB..... | 41 |
| Connecteurs sans raccord arrière..... | 42 |
| Conception spécifique..... | 44 |



SOLUTIONS RJ45 RENFORCÉES.....

49

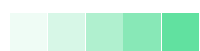

ACCESSOIRES

| | |
|---|----|
| Bouchons de protection..... | 60 |
| Bouchons à fermeture automatique..... | 62 |
| Contacts et obturateurs..... | 64 |
| Embase de repos, joint de panneau, bouchon de protection plastique..... | 64 |
| Manchon thermorétractable pour accessoire arrière..... | 65 |

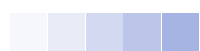

INSTALLATION - MISE EN OEUVRE

| | |
|------------------------------------|----|
| Perçage de panneau..... | 66 |
| Épaisseur de panneau..... | 66 |
| Couple de serrage..... | 66 |
| Perçage des circuits imprimés..... | 67 |

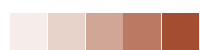

OPÉRATIONS DE SERTISSAGE

| | |
|----------------|----|
| Outils..... | 70 |
| Procédure..... | 71 |



Presentation / *Présentation*

You will find in this document the PT/451 connectors in accordance with the American MIL-DTL-26482 series I standard in crimp, solder, wire wrap and PCB contacts versions. Which are used in aeronautics, military and industrial applications. PT/451 Series offers you with a multitude of options through their different backshell possibilities, contact terminations, insert arrangements.

The same product can be ordered with different designations. The standard P/N includes both connector body and backshell. Please refer to PT and 451 ordering information on pages 14 to 17 to create your own part number.

For specific needs, you can order the connector body without backshell. In this case please refer to page 43 for specific ordering information.

We do not provide connectors with MS marking. Please have a look at the cross references chart mentioned on pages 18 and 19 to define your Amphenol equivalent part numbers.

Vous trouverez dans ce document les connecteurs PT/451 conformes à la norme américaine MIL-DTL-26482 série I en version de contacts à sertir, à souder, à wrapper ou à piquer, utilisés pour les applications aéronautiques, militaires et industrielles. La série PT/451 vous offre une gamme étendue de connecteurs proposant différentes possibilités de raccords, de terminaisons de contacts et arrangements de contacts.

Vous pouvez commander le même produit sous différentes désignations. La référence standard correspond au connecteur avec son raccord arrière. Veuillez vous référer aux pages 14 à 17 pour définir vos propres références.

En fonction de vos besoins, vous pouvez commander le connecteur sans raccord arrière. Dans ce cas, reportez vous à la page 43 pour définir les références.

Nous ne réalisons pas le marquage MS. Veuillez ainsi vous référer au tableau comparatif pages 18 et 19 pour définir vos références Amphenol équivalentes.

Applications / *Applications*

Industrial and military applications / *Applications industrielles et militaires*

- Outdoor Industry Applications
- Oil & Gas
- RMT
- C4ISR
- Ground Vehicles
- Measure / Instrumentation
- *Applications industrielles extérieures*
- *Recherche de pétrole et gaz*
- *Ferroviaire*
- *C4ISR*
- *Véhicules terrestres*
- *Mesure / Instrumentation*

General Characteristics / *Caractéristiques générales*

- Aluminium alloy
- Carbon steel (for hermetic receptacles)
- Stainless steel and bronze (please consult us)
- *Alliage d'Aluminium*
- *Acier (pour embases hermétiques)*
- *Acier inoxydable et bronze (veuillez nous contacter)*

Shell Finish / *Protection du boîtier*

- Olive drab cadmium plating
- Electroless nickel plating - RoHS compliant
- Black Zinc Nickel plating - RoHS compliant
- Tin plating (for hermetic receptacles)
- Others, please consult us (bright cadmium, black anodic coating, black electrophoretic coating, cadmium free versions)
- *Revêtement cadmié vert-olive*
- *Revêtement Nickel - Conforme RoHS*
- *Zinc Nickel Noir - Conforme RoHS*
- *Revêtement étamé (pour embases hermétiques)*
- *Autres, veuillez nous consulter (cadmium blanc, anodisation noire, électrophorèse noire, versions sans cadmium)*

9 shell sizes from 8 to 24 / *9 tailles de boîtiers de 8 à 24*

Contacts / *Contacts*

- 36 different arrangements of contacts
- Contacts sizes 20 and 16
- Signal (7,5 A): wire soldering, crimp, PCB, wire wrap
- Power (13 A): wire soldering, crimp, PCB
- *36 arrangements différents de contacts*
- *Contacts tailles 20 et 16*
- *Signal (7,5 A) : à souder sur fil, à sertir, à piquer, à wrapper*
- *Puissance (13 A) : à souder sur fil, à sertir, à piquer*

EMI/RFI protection / *Protection CEM*

- Grounding ring on the plug shell for PTG06 / 45136 types
- *Bague de blindage sur le corps de fiche pour les types PTG06 / 45136*



PT/451 connectors cross section / *Coupe de connecteurs PT/451*

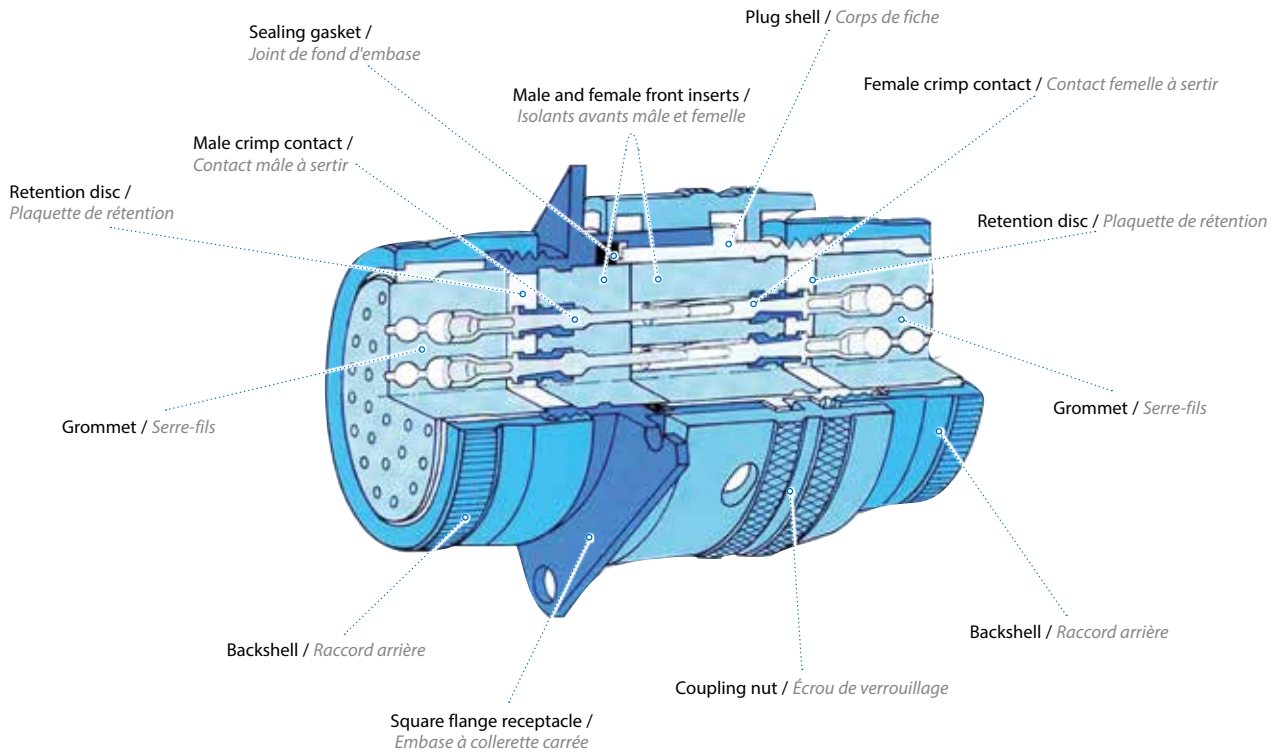

Crimp version cross section (mated pair)
Coupe de version à sertir (connecteurs assemblés)



PCB receptacle cross section
Coupe d'embase PCB

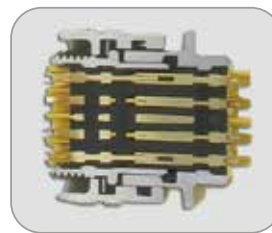

Solder version cross section (mated pair)
Coupe de version à souder (connecteurs assemblés)

Mechanical characteristics / *Caractéristiques mécaniques*

Insert and grommet / *Isolant et serre-fils*

Solder and PCB versions:

- 36 different insert arrangements
- Insert in Neoprene elastomer (Insert in Viton: please consult us)
- Rear elastomer grommet independant of the insert to allow soldering process

Crimp version:

- 25 different insert arrangements
- Insert in three parts: front insert, retention disc and grommet
- Retention of the contacts in the insert ensured by a hard retention disc

Versions à souder et à piquer :

- 36 arrangements de contacts différents
- Isolant en néoprène élastomère (Isolant en Viton : nous consulter)
- Serre-fils indépendant de l'isolant pour permettre le process de soudure

Version à sertir :

- 25 arrangements de contacts différents
- Isolant en trois parties : isolant avant, plaquette de rétention et serre-fils.
- Le maintien des contacts dans l'isolant est assuré par une plaquette de rétention

Contacts / *Contacts*

Solder and PCB versions:

- Sizes 20 and 16 non-removable gold plated contacts

Crimp version:

- Sizes 20 and 16 crimp removable gold plated contacts, front release (delivered non-mounted in the insert to allow crimping process)

Versions à souder et à piquer :

- Contacts dorés non démontables tailles 20 et 16

Version à sertir :

- Contacts à sertir dorés, démontables (par l'avant) tailles 20 et 16 (livrés non montés dans l'isolant pour permettre l'opération de sertissage)

Contact retention in the insert:

Rétention des contacts dans l'isolant :

| | Size 20 / Taille 20 | Size 16 / Taille 16 |
|-------------------|---------------------|---------------------|
| Solder / A souder | 67 N | 110 N |
| Crimp / A sertir | 67 N | 110 N |

Durability: 500 cycles (full mating - unmating)

Endurance mécanique : 500 cycles (verrouillage - déverrouillage)

Environmental characteristics / *Caractéristiques environnementales*

- **Operating temperature:** -55°C / +125°C
- **Salt spray exposure:** > 48h
- **Sealing:** air leakage < 16 cm³ per hour under 2 bar of differential pressure (for solder and PCB versions)
- **Hermeticity:** leak ≤ 10⁻⁶ cm³.s⁻¹ under 1 bar differential pressure (for hermetic versions)
- **Température d'utilisation :** -55°C / +125°C
- **Résistance au brouillard salin :** > 48h
- **Étanchéité :** fuite < 16 cm³ par heure sous 2 bar de pression différentielle (en versions à souder et PCB)
- **Herméticité :** fuite ≤ 10⁻⁶ cm³.s⁻¹ sous 1 bar de pression différentielle (pour les versions hermétiques)

Electrical characteristics / *Caractéristiques électriques*

| | Size 20 contacts (ø 1mm) <i>Contacts taille 20</i> | Size 16 contacts (ø 1,57mm) <i>Contacts taille 16</i> | |
|---|---|--|-----------|
| | | Service 1 | Service 2 |
| Recommended operating voltage at sea level <i>Tension de service recommandée au niveau de la mer</i> | 600 Vrms | 600 Vrms | 1000 Vrms |
| Test voltage at sea level <i>Tension d'essai au niveau de la mer</i> | 1500 Vrms | 1500 Vrms | 2300 Vrms |
| Test voltage at 21000m <i>Tension d'essai à 21000m</i> | 375 Vrms | 375 Vrms | 500 Vrms |
| Current rating per contact* <i>Intensité max par contact*</i> | 7.5 A | 13 A | |
| Insulation resistance at ambient <i>Résistance d'isolement (air ambiant)</i> | ≥ 5000 MOhm | ≥ 5000 MOhm | |
| Contact resistance at ambient <i>Résistance de contact (air ambiant)</i> | ≤ 2 mOhm | ≤ 1.5 mOhm | |

*: Current rating must not be applied at the same time to 50% of the contacts of the connector.

*: L'intensité maximale ne doit pas être appliquée en même temps à plus de 50% des contacts d'un même connecteur.

Contact dimensions and wire sizes

Dimensions des contacts et tailles des conducteurs

| Contacts | | | Jauge Mil-W-5086 | Section (mm ²) | Diameter in mm / <i>Diamètre en mm</i> | | | |
|--------------------------|----------------------|---------|---------------------|-------------------------------|--|------|-----------------------------------|------|
| | | | | | on conductor / <i>sur âme</i> | | on insulator / <i>sur isolant</i> | |
| Type | Size / <i>Taille</i> | ø in mm | | | min. | max. | min. | max. |
| Solder / <i>A souder</i> | 20 | 1 | 22 to 18 | 0.38-0.93 | - | 1.3 | 1.2 | 2.4 |
| | 16 | 1.57 | 20 to 14 | 0.60-1.91 | - | 1.6 | 1.6 | 2.8 |
| Crimp / <i>A sertir</i> | 20 | 1 | 24* to 18 | 0.22*-0.93 | 0.6 | 1.3 | 1.2 | 2.4 |
| | 16 | 1.57 | 22 to 14 | 0.38-1.91 | - | 1.6 | 1.6 | 2.8 |

*: Possible when used with reducing sleeves (see page 56 for ordering information).

*: Possible lorsqu'il est utilisé avec des manchons réducteurs (voir page 56 pour commander).

Coding system / Alternate insert position *Système de codage / Orientation de l'isolant*

To avoid cross-plugging issues in applications requiring the use of more than one PT/451 connector of the same size and arrangement, alternate coding positions are available as indicated in the chart below.

As shown in the diagram below, the front face of the pin insert is rotated within the shell in a clockwise direction from the main shell key.

Afin d'éviter les problèmes d'inversion de branchement dans les applications qui nécessitent plus d'un connecteur PT/451 de la même taille et avec le même arrangement, il est possible de configurer des positions de codage tel qu'indiqué dans le tableau ci-dessous. Les schémas ci-dessous montrent que la face avant de l'isolant mâle a été tournée dans le boîtier dans le sens des aiguilles d'une montre par rapport à la clé principale du boîtier.

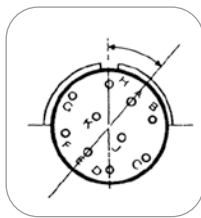

Position W

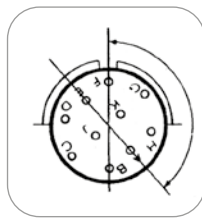

Position X

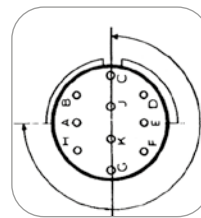

Position Y

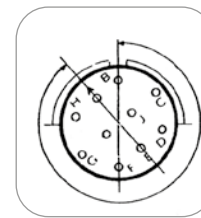

Position Z

Diagrams show front face of pin insert or rear face of socket insert
Vues de la face avant de l'isolant mâle ou de la face arrière de l'isolant femelle

| Shell size <i>Taille du boîtier</i> | Insert arrangement <i>Arrangement de contact</i> | Insert rotation (in degrees) / <i>Rotation de l'isolant (en degrés)</i> | | | |
|--|---|--|-----|-----|-----|
| | | W | X | Y | Z |
| 8 | 8-2 | 58 | 122 | - | - |
| 8 | 8-3 | 60 | 210 | - | - |
| 8 | 8-3A | 60 | - | - | - |
| 8 | 8-33 | 90 | - | - | - |
| 8 | 8-4 | 45 | - | - | - |
| 10 | 10-6 | 90 | - | - | - |
| 10 | 10-7 | - | - | - | - |
| 10 | 10-98 | 90 | 180 | 240 | 270 |
| 12 | 12-3 | - | - | 180 | - |
| 12 | 12-8 | 90 | 112 | 203 | 292 |
| 12 | 12-10 | 60 | 155 | 270 | 295 |
| 12 | 12-14 | - | - | - | - |
| 14 | 14-5 | 40 | 92 | 184 | 273 |
| 14 | 14-12 | 43 | 90 | - | - |
| 14 | 14-15 | 17 | 110 | 155 | 234 |
| 14 | 14-18 | 15 | 90 | 180 | 270 |
| 14 | 14-19 | 30 | 165 | 315 | - |
| 16 | 16-8 | 54 | 152 | 180 | 331 |

| Shell size <i>Taille du boîtier</i> | Insert arrangement <i>Arrangement de contact</i> | Insert rotation (in degrees) / <i>Rotation de l'isolant (en degrés)</i> | | | |
|--|---|--|-----|-----|-----|
| | | W | X | Y | Z |
| 16 | 16-23 | 158 | 270 | - | - |
| 16 | 16-26 | 60 | - | 275 | 338 |
| 18 | 18-11 | 62 | 119 | 241 | 340 |
| 18 | 18-30 | 180 | 193 | 285 | 350 |
| 18 | 18-32 | 85 | 138 | 222 | 265 |
| 20 | 20-16 | 238 | 318 | 333 | 347 |
| 20 | 20-24 | 70 | 145 | 215 | 290 |
| 20 | 20-25 | 72 | 144 | 216 | 288 |
| 20 | 20-27 | 72 | 144 | 216 | 288 |
| 20 | 20-39 | 63 | 144 | 252 | 333 |
| 20 | 20-41 | 45 | 126 | 225 | - |
| 22 | 22-21 | 16 | 135 | 175 | 349 |
| 22 | 22-32 | 72 | 145 | 215 | 288 |
| 22 | 22-34 | 62 | 142 | 218 | 298 |
| 22 | 22-36 | 72 | 144 | 216 | 288 |
| 22 | 22-41 | 39 | 135 | 264 | - |
| 22 | 22-55 | 30 | 142 | 226 | 314 |
| 24 | 24-61 | 90 | 180 | 270 | 324 |

| | |
|------------------|---------------|
| 45100RRCxxx * 50 | HE30 |
| 45100RTTxxx * 50 | HE30 |
| 45100RPPxxx * 50 | HE301B00RPP |
| 45101Axxx * 50 | HE301B01Axxx |
| 45101ACxxx * 50 | HE301B01ACxxx |
| 45101PG50 | HE301B01PG50 |
| 45101Exxx * 50 | HE301B01Exxx |
| 45101ECxxx * 50 | HE301B01ECxxx |
| 45101Txxx * 50 | HE301B01Txxx |
| 45101EKxxx * 50 | HE301B01EKxxx |
| 45101KMxxx * 50 | HE301B01KMxxx |
| 45101Pxxx * 50 | HE301B01Pxxx |
| 45101Jxxx * 50 | HE301B01Jxxx |
| 45101RCxxx * 50 | HE301B01RCxxx |

Insert arrangements - Front view of male insert

Arrangements de contacts - Vue face avant de l'isolant mâle

- 1 Insert arrangement reference / Arrangements de contacts
- 2 Service rating / Service (see page 8 / Voir page 8)
- 3 Number of contacts / Nombre de contacts
- 4 Contact size / Taille des contacts

| | | | | | |
|-----------|------------|------------|--------------------|-------------|------------|
| 08 | | | | | |
| | 1 | 2 | 3 | 3 | 4 |
| | 8-2 | 8-3 | 8-3A (8-98) | 8-33 | 8-4 |
| | 1 | 1 | 1 | 1 | 1 |
| | 20 | 20 | 20 | 20 | 20 |

| | | | |
|-----------|-------------|--------------|-------------|
| 10 | | | |
| | 1 | 6 | 7 |
| | 10-6 | 10-98 | 10-7 |
| | 1 | 1 | 1 |
| | 20 | 20 | 20 |

| | | | | |
|-----------|-------------|-------------|--------------|--------------|
| 12 | | | | |
| | 2 | 8 | 10 | 14 |
| | 12-3 | 12-8 | 12-10 | 12-14 |
| | 2 | 1 | 1 | 1 |
| | 16 | 20 | 20 | 20 |

| | | | | | |
|-----------|-------------|--------------|--------------|--------------|--------------|
| 14 | | | | | |
| | 2 | 8 | 14 | 18 | 19 |
| | 14-5 | 14-12 | 14-15 | 14-18 | 14-19 |
| | 2 | 1 | 1 | 1 | 1 |
| | 16 | 20 | 20 | 20 | 20 |

| | | | |
|-----------|-------------|--------------|--------------|
| 16 | | | |
| | 2 | 22 | 26 |
| | 16-8 | 16-23 | 16-26 |
| | 2 | 1 | 1 |
| | 16 | 20 | 16 |

H: Available in hermetic version
H: Disponible en version hermétique

C: Available in crimp version
C: Disponible en version à sertir

P: For those arrangements, please contact us for available configurations (G, PG and SQ backshells are not available). Only available with PT marking

P: Pour ces arrangements, nous consulter pour les configurations possibles (raccords G, PG, et SQ non disponibles). Marquage PT seulement

Contact Legend / Légende des contacts

| Symbol / Symbole | Contact size / Taille du contact |
|------------------|----------------------------------|
| ○ | 20 |
| ● | 16 |

Top-runners / Les plus standard

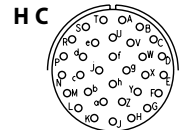
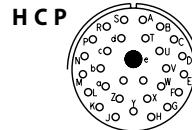
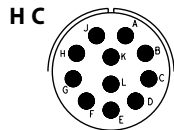

| | | | | | | | |
|----|---|--------------|--|--------------|----|--------------|--|
| 18 | ① | 18-11 | | 18-30 | | 18-32 | |
| | ② | 2 | | 1 | | 1 | |
| | ③ | 11 | | 29 | 1 | 32 | |
| | ④ | 16 | | 20 | 16 | 20 | |

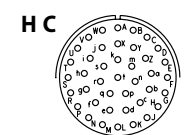
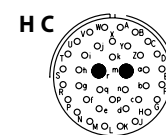
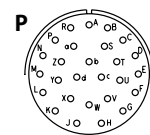
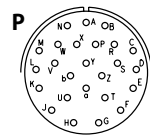
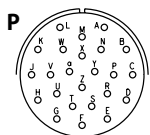
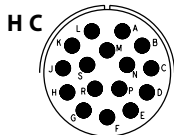

| | | | | | | | |
|----|---|--------------|--------------|--------------|--------------|--------------|--------------|
| 20 | ① | 20-16 | 20-24 | 20-25 | 20-27 | 20-39 | 20-41 |
| | ② | 2 | 1 | 1 | 1 | 1 | 1 |
| | ③ | 16 | 24 | 25 | 27 | 37 | 41 |
| | ④ | 16 | 20 | 20 | 20 | 20 | 20 |

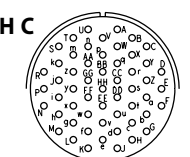
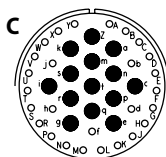
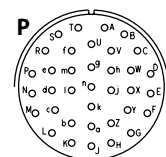
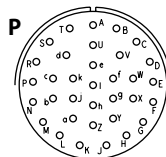
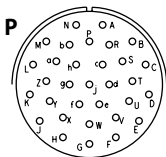
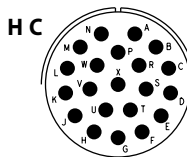

| | | | | | | | |
|----|---|--------------|--------------|--------------|--------------|--------------|--------------|
| 22 | ① | 22-21 | 22-32 | 22-34 | 22-36 | 22-41 | 22-55 |
| | ② | 2 | 1 | 1 | 1 | 1 | 1 |
| | ③ | 21 | 32 | 34 | 36 | 27 | 55 |
| | ④ | 16 | 20 | 20 | 20 | 20 | 20 |

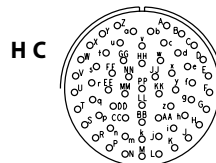

| | | | |
|----|---|--------------|--|
| 24 | ① | 24-61 | |
| | ② | 1 | |
| | ③ | 61 | |
| | ④ | 20 | |













- Caution: 8-3A and 8-3 insert arrangements are not intermatable
- All insert arrangements mentioned are available in solder version
- Contact us for availability of other insert arrangements

- Attention: les arrangements 8-3A et 8-3 ne peuvent pas s'accoupler
- Tous les arrangements de contacts existent en version à souder
- Veuillez nous contacter pour les arrangements ne figurant pas dans ce tableau

Shells and backshells, possible combinations

Boîtiers et raccords, combinaisons possibles









Solder version / Version à souder





| Straight backshell Raccord droit | Simple backshell Raccord simple | | Cable clamp backshell Raccord serre-câble | | Sealed backshell Raccord étanche | | | | Braid clamping backshell Raccord pour reprise de tresse | |
|---|---|---|---|---|---|---|--|---|--|--|
| PT 451 |  A A |  E E |  A (SR) AC |  E (SR) EC |  W J |  P P |  E (J) T |  A (PG) A (PG) |  G |  E (SQ) G |
| 00  Square flange receptacle Embase à collerette carrée | ✓ | ✓ | ✓ | ✓ | ✓ | ✓ | ✓ | ✓ | | ✓ |
| 01  Inline receptacle Prolongateur | ✓ | ✓ | ✓ | ✓ | ✓ | ✓ | ✓ | ✓ | | ✓ |
| 02  Square flange receptacle without rear accessory possibility Embase carrée sans possibilité de raccord | PT02A/PT02C 45102E No rear accessory Ne comporte pas le raccord | | | | | | | | | |
| 06  Straight plug / Fiche droite | ✓ | ✓ | ✓ | ✓ | ✓ | ✓ | ✓ | ✓ | ✓ | ✓ PTG06 / 45136 |
| 07  Jam nut receptacle Embase à fixation par écrou | PT07A/ PT07C 45107A No rear accessory Ne comporte pas de raccord | ✓ | | ✓ | | ✓ | | ✓ | | ✓ |
| 09  Square flange receptacle with locking ring Embase carrée à écrou | PT009A 45109E No rear accessory Ne comporte pas de raccord | | | | | | | | | |

| Rightangle backshell Raccord 90° | Cable clamp backshell Raccord serre-câble | Potting Potting | Braid clamping backshell Raccord pour reprise de tresse | |
|---|---|--|---|---|
| PT / 451 |  E(SR) / EC |  P / P |  G |  PTSA |
| 08  Plug for right angle backshell Fiche pour raccord coudé | ✓ | ✓ | ✓ | |
| G55  Straight plug / Fiche droite | | | | ✓ |

* : Suffixe à mettre dans la partie «Particularité des raccords arrière»

Crimp version / *Version à sertir*

| | Simple backshell <i>Raccord simple</i> | | Cable clamp backshell <i>Raccord serre-câble</i> | Sealed backshell <i>Raccord étanche</i> | | | Braid clamping backshell <i>Raccord pour reprise de tresse</i> |
|---|---|---|---|---|---|---|---|
| |  |  |  |  |  |  |  |
| PT 451 | RA | SE R | SE (SR) RC | SP RP | SE (J) RT | SE (PG) R (PG) | SE (SQ) RG |
| 00  <i>Square flange receptacle</i> <i>Embase à collerette carrée</i> | ✓ | ✓ | ✓ | ✓ | ✓ | ✓ | ✓ |
| 01  <i>Inline receptacle</i> <i>Prolongateur</i> | ✓ | ✓ | ✓ | ✓ | ✓ | ✓ | ✓ |
| 02  <i>Square flange receptacle without rear accessory possibility</i> <i>Embase carrée sans possibilité de raccord</i> | | PT02SE 45102R <i>No rear accessory</i> <i>Ne comporte pas de raccord</i> | | | | | |
| 06  <i>Straight plug / Fiche droite</i> | ✓ | ✓ | ✓ | ✓ | ✓ | ✓ | ✓ PTG06 / 45136 |
| 07  <i>Jam nut receptacle</i> <i>Embase à fixation par écrou</i> | | ✓ | ✓ | ✓ | | | ✓ |

| | Cable clamp backshell <i>Raccord serre-câble</i> | Braid clamping backshell <i>Raccord pour reprise de tresse</i> |
|---|---|---|
| |  |  |
| PT 451 | SE (SR) RC | PTSA |
| 08  <i>Plug for right angled backshell</i> <i>Fiche pour raccord coudé</i> | ✓ | |
| G55  <i>Straight plug / Fiche droite</i> | | ✓ |

Note: EK, KM, SK backshells are not indicated in these charts because they are not often used for new developments.

Note : Les raccords EK, KM, SK ne sont pas mentionnés dans ces tableaux car ils ne sont pas souvent utilisés pour les nouveaux développements.

HOW TO ORDER - Amphenol Designation: PT

Solder, Crimp, PCB, wire wrap versions. Connector with rear accessory

| PT Series | PT | 00 | E | 12 | 10 | P | - | - | - |
|---|----|----|---|----|----|---|---|---|---|
| <p>Shell type: 00: Square flange receptacle with rear accessory possibility 01: Inline receptacle 02: Square flange receptacle without rear accessory possibility 06: Straight plug G06: Straight plug with grounding ring for braid clamping backshell 07: Jam nut receptacle 08: Right angled plug 09: Square flange receptacle with locking ring I: Solder mounting receptacle (hermetic version) B: Through bulkhead receptacle</p> <p>Backshell type (special backshells at pages 47-48): Solder version: A: Intermediate backshell Exception for PT02, PT07, PT09: no rear accessory E: Backnut Exception for PT02: no rear accessory C: Air leakage controlled for PT02 & PT07, no rear accessory A + SR: Cable clamp backshell delivered without grommet E + SR/J/SQ: Backshell delivered with grommet (see «rear accessory particularity» for the backshell type) A+PG: PG backshell (see «rear accessory particularity» for the description) W: Sealing gland backshell - IP68 P: Backshell for potting G: Braid soldering backshell H: Hermetic version EK(x)*: Immersion proof sealing gland backshell with strong cable grip KM(x)*: Rain proof sealing gland backshell with strong cable grip and earth line</p> <p>Crimp version: SE: Backnut Exception for PT02: no rear accessory (standard version) SE + SR/J/PG/SQ: See «rear accessory particularity» for the backshell type SP: Backshell for potting SK(x)*: Immersion proof sealing gland backshell with strong cable grip</p> <p>Other versions: Y/YS/GS: PCB version (see page 38) MW: Wire wrap version (see page 39) Blank: for through bulkhead receptacle</p> <p>Shell size: 8/10/12/14/16/18/20/22/24</p> <p>Contact insert arrangement: See page 10 & 11</p> <p>Contact type: P: Pin S: Socket PS: For through bulkhead receptacle</p> <p>Coding / Insert alternate positioning: Blank for normal or W, X, Y, Z (see coding system page 9)</p> <p>Rear accessory particularity: SR: Cable clamp backshell J: Backnut for heatshrink moulded piece PG: Straight adaptor terminated by a PG type plastic sealing gland SQ: Braid clamping backshell</p> <p>Shell finish: Omit for standard olive drab cadmium. Hermetic connectors are all supplied with tin plated shells. 023: Electroless nickel - ROHS compliant 033K: Black Zinc Nickel - ROHS compliant - Standard backshells available : A, E/SE, J, PG, SQ. For other please consult us.</p> | | | | | | | | | |

*: Replace «x» after EK, KM or SK by the number of the corresponding gasket (refer to end of page 34).

COMMENT COMMANDER - Désignation Amphenol : PT

Versions à souder, à sertir, à piquer, à wrapper. Connecteur avec raccord arrière

| Série PT | PT | 00 | E | 12 | 10 | P | - | - | - |
|---|----|----|---|----|----|---|---|---|---|
| <p>Type de boîtier (Connecteur sans raccord arrière p42-43): 00 : Embase à collerette carrée avec possibilité de raccord 01 : Prolongateur 02 : Embase à collerette carrée sans possibilité de raccord 06 : Fiche droite G06 : Fiche droite avec bague de masse pour raccord à reprise de tresse 07 : Embase à fixation par écrou 08 : Fiche coudée 09 : Embase à collerette carrée avec écrou de verouillage I : Embase à fixation par brasage (version hermétique) B : Traversée de cloison</p> <p>Type de raccord arrière (raccords spéciaux pages 47-48): Version à souder : A : Raccord intermédiaire Exception en PT02, PT07, PT09 : sans possibilité de raccord arrière E : Ecrou serre-fils Exception en PT02 : sans possibilité de raccord arrière C : Etanchéité contrôlée pour PT02 et PT07, sans possibilité de raccord arrière A + SR : Serre câble fourni sans serre-fils E + SR/J/SQ : Raccord fourni avec serre-fils (voir «particularité des raccords arrières» pour le type de raccord) A+PG : Raccord PG (voir «particularité des raccords arrières» pour la description) W : Raccord presse-étoupe - IP68 P : Raccord pour potting G : Raccord pour reprise de tresse avec terminaison étamée pour soudure de la tresse H : Version hermétique EK(x)* : Raccord presse-étoupe étanche à l'immersion KM(x)* : Raccord presse-étoupe étanche au ruissellement et continuité de masse</p> <p>Version à sertir : SE : Ecrou serre-fils Exception en PT02 : sans possibilité de raccord arrière SE + SR/J/PG/SQ : voir «particularité des raccords arrières» pour le type de raccord SP : Raccord pour potting SK(x)* : Raccord presse-étoupe étanche à l'immersion</p> <p>Autres versions : Y/YS/GS : Version à piquer sur circuit imprimé (voir page 38) MW : Version à wrapper (voir page 39) Néant : Pour traversée de cloison</p> <p>Taille de boîtier : 8/10/12/14/16/18/20/22/24</p> <p>Arrangement de contact : voir page 10 et 11</p> <p>Type de contact : P : Mâle S : Femelle PS : Pour traversée de cloison</p> <p>Codage / Orientation de l'isolant : Néant pour normal ou W, X, Y, Z (voir le système de codage page 9)</p> <p>Particularité des raccords arrières : SR : Serre-câble J : Raccord pour pièce moulée thermorétractable PG : Raccord intermédiaire raccordé à un presse-étoupe PG plastique SQ : Raccord pour reprise de tresse</p> <p>Traitement du boîtier : Néant pour le cadmié vert olive. Les connecteurs hermétiques sont tous fournis avec un boîtier étamé. 023 : Nickel chimique - conforme ROHS 033K : Zink Nickel Noir - conforme ROHS - Raccords standard disponibles : A, E/SE, J, PG, SQ. Pour les autres, veuillez nous contacter.</p> | | | | | | | | | |

* : Remplacer «x» après EK, KM ou SK par le numéro de joint correspondant (se référer au bas de la page 34).

HOW TO ORDER - NFL 54125 Designation: 451

Solder, Crimp, PCB, Wire wrap versions. Connector with rear accessory

| | | | | | | | | | | |
|-------------------|------------|-----------|-----------|-----------|-----------|----------|----------|----------|-----------|----------|
| 451 Series | 451 | 00 | EC | 12 | 10 | P | - | - | 50 | - |
|-------------------|------------|-----------|-----------|-----------|-----------|----------|----------|----------|-----------|----------|

Shell type:

- 00:** Square flange receptacle with rear accessory possibility
- 01:** Inline receptacle
- 02:** Square flange receptacle without rear accessory possibility
- 06:** Straight plug
- 36:** Straight plug with grounding ring for braid clamping backshell
- 07:** Jam nut receptacle
- 08:** Right angled plug
- 09:** Square flange receptacle with locking ring

Backshell type (special backshells at pages 47-48):**Solder version:**

- A:** Intermediate backshell
- Exception for 451 07:** no rear accessory
- E:** Backnut
- Exception for 451 02 and 451 09:** no rear accessory
- A+PG:** PG backshell (see «rear accessory particularity» for the description)
- AC:** Cable clamp backshell delivered without grommet
- EC:** Cable clamp delivered with grommet
- J:** Sealing gland backshell - IP68
- T:** Backnut for heatshrink moulded piece
- P:** Backshell for potting
- G:** Braid clamping backshell
- EK(x)*:** Immersion proof sealing gland backshell with strong cable grip
- KM(x)*:** Rain proof sealing gland backshell with strong cable grip and earth line

Crimp version:

- RA:** Intermediate backshell
- R:** Backnut
- Exception for 451 02:** no rear accessory
- R+PG:** PG backshell (see «rear accessory particularity» for the description)
- RC:** Cable clamp backshell
- RT:** Backnut for heatshrink moulded piece
- RP:** Backshell for potting
- RG:** Braid clamping backshell
- SK(x)*:** Immersion proof sealing gland backshell with strong cable grip

Other versions:

- Y/YS/GS:** PCB version (see page 38)
- MW:** Wire wrap version (see page 39)
- Blank:** for through bulkhead receptacle

Shell size: 8/10/12/14/16/18/20/22/24**Contact insert arrangement:** See page 10 and 11**Contact type:**

- P:** Pin
- S:** Socket
- PS:** For through bulkhead receptacle

Coding / Insert alternate positioning:

Blank for normal or W, X, Y, Z (see coding system page 9)

Rear accessory particularity:

- PG:** Straight adaptor terminated by a PG type plastic sealing gland

50: Obligatory suffix**Shell finish:**

- Blank for standard olive drab cadmium.
- 70:** Electroless nickel - RoHS compliant
- 033K:** Black Zinc Nickel - RoHS compliant - Standard backshells available : A/RA, E/R, T/RT, PG, G/RG. For other please consult us.

*: Replace «x» after EK, KM or SK by the number of the corresponding gasket (refer to end of page 34).

COMMENT COMMANDER - Désignation NFL 54125: 451

Versions à souder, à sertir, à piquer, à wrapper. Connecteur avec raccord arrière

| | | | | | | | | | | |
|------------------|------------|-----------|-----------|-----------|-----------|----------|----------|----------|-----------|----------|
| Série 451 | 451 | 00 | EC | 12 | 10 | P | - | - | 50 | - |
|------------------|------------|-----------|-----------|-----------|-----------|----------|----------|----------|-----------|----------|

Type de boîtier :

- 00** : Embase à collerette carrée avec possibilité de raccord
01 : Prolongateur
02 : Embase à collerette carrée sans possibilité de raccord
06 : Fiche droite
36 : Fiche droite avec bague de masse pour raccord à reprise de tresse
07 : Embase à fixation par écrou
08 : Fiche coudée
09 : Embase à collerette carrée avec écrou de verouillage

Type de raccord arrière (raccords spéciaux pages 47-48):**Version à souder :**

- A** : Raccord intermédiaire
Exception en 451 07 : sans possibilité de raccord arrière
E : Ecrou serre-fils
Exception en 451 02 et 451 09 : sans possibilité de raccord arrière
A+PG : Raccord PG (voir «particularité des raccords arrières» pour la description)
AC : Serre câble fourni sans serre-fils
EC : Serre câble fourni avec serre-fils
J : Raccord presse-étoupe - IP68
T : Raccord pour pièce moulée thermorétractable
P : Raccord pour potting
G : Raccord pour reprise de tresse
EK(x)* : Raccord presse-étoupe étanche à l'immersion
KM(x)* : Raccord presse-étoupe étanche au ruissellement et continuité de masse

Version à sertir :

- RA** : Raccord intermédiaire
R : Ecrou serre-fils
Exception en 451 02 : sans possibilité de raccord arrière
R+PG : Raccord PG (voir «particularité des raccords arrières» pour la description)
RC : Raccord serre-câble
RT : Raccord pour pièce moulée thermorétractable
RP : Raccord pour potting
RG : Raccord pour reprise de tresse
SK(x)* : Raccord presse-étoupe étanche à l'immersion

Autres versions :

- Y/YS/GS** : Version à piquer sur circuit imprimé (voir page 38)
MW : Version à wrapper (voir page 39)

Taille de boîtier : 8/10/12/14/16/18/20/22/24

Arrangement de contact : voir page 10 et 11

Type de contact :

- P** : Mâle
S : Femelle
PS : Pour traversée de cloison

Codage / Orientation de l'isolant :

Néant pour normal ou W, X, Y, Z (voir le système de codage page 9)

Particularité des raccords arrières :

PG : Raccord intermédiaire raccordé à un presse-étoupe PG plastique

50 : Suffixe obligatoire

Traitement du boîtier :

- Néant pour le cadmié vert olive standard.
70 : Nickel chimique - conforme RoHS
033K : Zink Nickel Noir - conforme RoHS - Raccords standard disponibles : A/RA, E/R, T/RT, PG, G/RG. Pour les autres, veuillez nous contacter.

* : Remplacer «x» après EK, KM ou SK par le numéro de joint correspondant (se référer au bas de la page 34).

Cross references chart / *Tableau d'équivalences*

| AMPHENOL PT designation | BNAE NF. L54125 451 designation | NFC 93422 HE301 designation | MIL-DTL-26482 Series I | VG 95328 |
|------------------------------------|--|--|-----------------------------------|--------------------|
| PT00A xx-xx x* | 45100A xx-xx x* 50 | HE301B00A xx-xx x* 1A | | |
| PT00A xx-xx x* SR | 45100AC xx-xx x* 50 | HE301B00AC xx-xx x* 1A | | |
| PT00A xx-xx x* PG | 45100A xx-xx x* PG50 | | | |
| PT00E xx-xx x* | 45100E xx-xx x* 50 | HE301B00E xx-xx x* 1A | MS3110E xx-xx x* | |
| PT00E xx-xx x* SR | 45100EC xx-xx x* 50 | HE301B00EC xx-xx x* 1A | MS3110F xx-xx x* | |
| PT00E xx-xx x* J | 45100T xx-xx x* 50 | | | |
| PT00P xx-xx x* | 45100P xx-xx x* 50 | HE301B00P xx-xx x* 1A | MS3110P xx-xx x* | |
| PT00E xx-xx x* SQ | 45100G xx-xx x* 50 | | | |
| PT00W xx-xx x* | 45100J xx-xx x* 50 | HE301B00J xx-xx x* 1A | | |
| PT00SE xx-xx x* | 45100R xx-xx x* 50 | HE301B00R xx-xx x* 1A | MS3120E xx-xx x* | VG 95328A xx-xx x* |
| PT00SE xx-xx x* SR | 45100RC xx-xx x* 50 | HE301B00RC xx-xx x* 1A | MS3120F xx-xx x* | VG 95328B xx-xx x* |
| PT00SE xx-xx x* PG | 45100R xx-xx x* PG50 | | | |
| PT00SE xx-xx x* J | 45100RT xx-xx x* 50 | | | |
| PT00SP xx-xx x* | 45100RP xx-xx x* 50 | HE301B00RP xx-xx x* 1A | MS3120P xx-xx x* | |
| PT00SE xx-xx x* SQ | 45100RG xx-xx x* 50 | | | VG 95328R xx-xx x* |
| PT01A xx-xx x* | 45101A xx-xx x* 50 | HE301B01A xx-xx x* 1A | | |
| PT01A xx-xx x* SR | 45101AC xx-xx x* 50 | HE301B01AC xx-xx x* 1A | | |
| PT01A xx-xx x* PG | 45101A xx-xx x* PG50 | | | |
| PT01E xx-xx x* | 45101E xx-xx x* 50 | HE301B01E xx-xx x* 1A | MS3111E xx-xx x* | |
| PT01E xx-xx x* SR | 45101EC xx-xx x* 50 | HE301B01EC xx-xx x* 1A | MS3111F xx-xx x* | |
| PT01E xx-xx x* J | 45101T xx-xx x* 50 | | | |
| PT01EK (x) xx-xx x* | 45101EK (x) xx-xx x* 50 | | | |
| PT01KM (x) xx-xx x* | 45101KM (x) xx-xx x* 50 | | | |
| PT01P xx-xx x* | 45101P xx-xx x* 50 | HE301B01P xx-xx x* 1A | MS3111P xx-xx x* | |
| PT01E xx-xx x* SQ | 45101G xx-xx x* 50 | | | |
| PT01W xx-xx x* | 45101J xx-xx x* 50 | HE301B01J xx-xx x* 1A | | |
| PT01SE xx-xx x* | 45101R xx-xx x* 50 | HE301B01R xx-xx x* 1A | MS3121E xx-xx x* | |
| PT01SE xx-xx x* SR | 45101RC xx-xx x* 50 | HE301B01RC xx-xx x* 1A | MS3121F xx-xx x* | |
| PT01SE xx-xx x* PG | 45101R xx-xx x* PG50 | | | |
| PT01SE xx-xx x* J | 45101RT xx-xx x* 50 | | | |
| PT01SK (x) xx-xx x* | 45101SK (x) xx-xx x* 50 | | | |
| PT01SP xx-xx x* | 45101RP xx-xx x* 50 | HE301B01RP xx-xx x* 1A | MS3121P xx-xx x* | |
| PTIH xx-xx x* | | | | |
| PT01SE xx-xx x* SQ | 45101G xx-xx x* 50 | | | |
| PT02A xx-xx x* | 45102E xx-xx x* 50 | HE301B02Exx-xx x* 1A | MS3112E xx-xx x* | VG 95328H xx-xx x* |
| PT02C xx-xx x* | | | | |
| PT02SE xx-xx x* | 45102R xx-xx x* 50 | HE301B02R xx-xx x* 1A | MS3122E xx-xx x* | VG 95328C xx-xx x* |
| PT02H xx-xx x* | | | | |
| PT02MW xx-xx x* | 45102MW xx-xx x* 50 | | | |
| PT02Y xx-xx x* | 45102Y xx-xx x* 50 | | | |
| PT02YS xx-xx x* | 45102YS xx-xx x* 50 | | | |
| PT02GS xx-xx x* | 45102GS xx-xx x* 50 | | | |

| AMPHENOL PT designation | BNAE NF. L54125 451 designation | NFC 93422 HE301 designation | MIL-DTL-26482 Series I | VG 95328 |
|----------------------------|------------------------------------|--------------------------------|---------------------------|--------------------|
| PT06A xx-xx x* | 45106A xx-xx x* 50 | HE301B06A xx-xx x* 1A | | |
| PT06A xx-xx x* SR | 45106AC xx-xx x* 50 | HE301B06AC xx-xx x* 1A | | |
| PT06A xx-xx x* PG | 45106A xx-xx x* PG50 | | | |
| PT06E xx-xx x* | 45106E xx-xx x* 50 | HE301B06E xx-xx x* 1A | MS3116E xx-xx x* | |
| PT06E xx-xx x* SR | 45106EC xx-xx x* 50 | HE301B06EC xx-xx x* 1A | MS3116F xx-xx x* | |
| PT06E xx-xx x* J | 45106T xx-xx x* 50 | | | |
| PT06EK (x) xx-xx x* | 45106EK (x) xx-xx x* 50 | | | |
| PT06KM (x) xx-xx x* | 45106KM (x) xx-xx x* 50 | | | |
| PT06G xx-xx x* | | | | |
| PT06P xx-xx x* | 45106P xx-xx x* 50 | HE301B06P xx-xx x* 1A | MS3116P xx-xx x* | |
| PTG06E xx-xx x* SQ | 45136G xx-xx x* 50 | | | |
| PT06W xx-xx x* | 45106J xx-xx x* 50 | HE301B06J xx-xx x* 1A | | |
| PT06SE xx-xx x* | 45106R xx-xx x* 50 | HE301B06R xx-xx x* 1A | MS3126E xx-xx x* | |
| PT06SE xx-xx x* SR | 45106RC xx-xx x* 50 | HE301B06RC xx-xx x* 1A | MS3126F xx-xx x* | VG 95328K xx-xx x* |
| PT06SE xx-xx x* PG | 45106R xx-xx x* PG50 | | | |
| PT06SE xx-xx x* J | 45106RT xx-xx x* 50 | | | VG 95328J xx-xx x* |
| PT06SK (x) xx-xx x* | 45106SK xx-xx x* 50 | | | |
| PT06SP xx-xx x* | 45106RP xx-xx x* 50 | HE301B06RP xx-xx x* 1A | MS3126P xx-xx x* | |
| PTG06SE xx-xx x* SQ | 45136RG xx-xx x* 50 | | | VG 95328M xx-xx x* |
| PT07A xx-xx x* | 45107A xx-xx x* 50 | HE301B07A xx-xx x* 1A | | |
| PT07A xx-xx x* SR | 45107AC xx-xx x* 50 | HE301B07AC xx-xx x* 1A | | |
| PT07C xx-xx x* | | | | |
| PT07E xx-xx x* | 45107E xx-xx x* 50 | HE301B07E xx-xx x* 1A | MS3114E xx-xx x* | |
| PT07E xx-xx x* SR | 45107EC xx-xx x* 50 | HE301B07EC xx-xx x* 1A | MS3114F xx-xx x* | |
| PT07P xx-xx x* | 45107P xx-xx x* 50 | HE301B07P xx-xx x* 1A | MS3114P xx-xx x* | |
| PT07SE xx-xx x* | 45107R xx-xx x* 50 | HE301B07R xx-xx x* 1A | MS3124E xx-xx x* | VG 95328D xx-xx x* |
| PT07SE xx-xx x* SR | 45107RC xx-xx x* 50 | HE301B07RC xx-xx x* 1A | MS3124F xx-xx x* | VG 95328E xx-xx x* |
| PT07SP xx-xx x* | 45107RP xx-xx x* 50 | HE301B07RP xx-xx x* 1A | MS3124P xx-xx x* | |
| PT07SE xx-xx x* SQ | 45107RG xx-xx x* 50 | | | VG 95328T xx-xx x* |
| PT07H xx-xx x* | | | | |
| PT07MW xx-xx x* | 45107MW xx-xx x* 50 | | | |
| PT07Y xx-xx x* | 45107Y xx-xx x* 50 | | | |
| PT07YS xx-xx x* | 45107YS xx-xx x* 50 | | | |
| PT07GS xx-xx x* | 45107GS xx-xx x* 50 | | | |
| PT08E xx-xx x* SR | 45108EC xx-xx x* 50 | HE301B08EC xx-xx x* 1A | | |
| PT08G xx-xx x* | | | | |
| PT08P xx-xx x* | 45108P xx-xx x* 50 | HE301B08P xx-xx x* 1A | | |
| PT08SE xx-xx x* SR | 45108RC xx-xx x* 50 | HE301B08RC xx-xx x* 1A | | |
| PT09A xx-xx x* | 45109E xx-xx x* 50 | | | |
| PTB xx-xx x* | | | | |

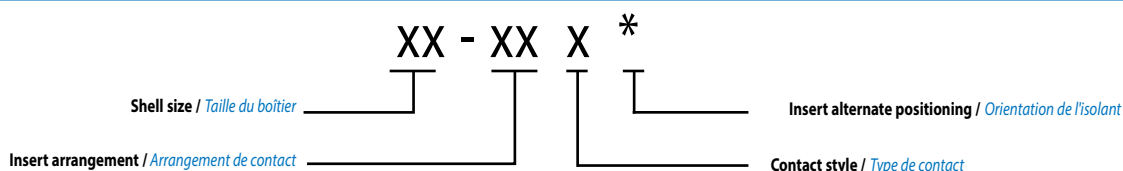

OVERALL DIMENSIONS

DIMENSIONS GÉNÉRALES

PT/451

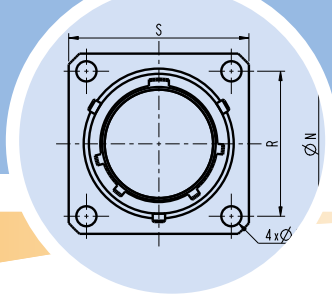

Square flange receptacles 02 type

Embases carrées type 02

| | | | |
|-------------------|---------------|--------|----------|
| Solder / A souder | PT02A / PT02C | 45102E | VG95328H |
| Crimp / A sertir | PT02SE | 45102R | VG95328C |

Square flange receptacle without rear accessory possibility.
Embase à collerette carrée sans possibilité de raccord.



Solder / A souder



Crimp / A sertir

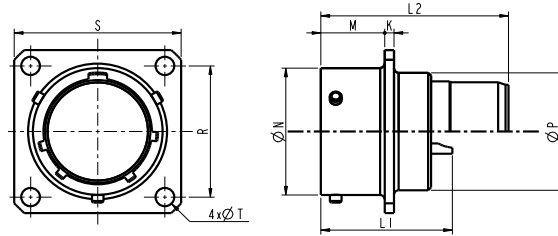

| Shell size Taille du boîtier | K max. | L1 max. Solder / Souder | L2 max. Crimp / Sertir | M | Ø N | Ø P max. | R | S | Ø T ± 0.1 |
|---------------------------------|--------|----------------------------|---------------------------|-------|-------|----------|-------|------|--------------|
| 8 | 1.57 | 23.6 | 32.3 | 10.95 | 12.01 | 11.4 | 15.09 | 20.6 | 3.2 |
| 10 | 1.57 | 23.6 | 32.3 | 10.95 | 14.99 | 14.6 | 18.26 | 23.8 | 3.2 |
| 12 | 1.57 | 23.6 | 32.3 | 10.95 | 19.05 | 17.8 | 20.62 | 26.2 | 3.2 |
| 14 | 1.57 | 23.6 | 32.3 | 10.95 | 22.23 | 20.9 | 23.01 | 28.6 | 3.2 |
| 16 | 1.57 | 23.6 | 32.3 | 10.95 | 25.40 | 24.1 | 24.61 | 31.0 | 3.2 |
| 18 | 1.57 | 23.6 | 32.3 | 10.95 | 28.58 | 27.3 | 26.97 | 33.3 | 3.2 |
| 20 | 2.39 | 29.1 | 33.9 | 14.12 | 31.75 | 30.5 | 29.36 | 36.5 | 3.2 |
| 22 | 2.39 | 29.1 | 33.9 | 14.12 | 34.93 | 33.6 | 31.75 | 39.7 | 3.2 |
| 24 | 2.39 | 29.1 | 35.4 | 14.96 | 38.10 | 36.8 | 34.93 | 42.9 | 3.73 |

Please note that, PT02A connectors from Amphenol Socapex are delivered with a sealing gasket.

Square flange receptacles 00 type

Embases carrées type 00

| | | |
|-------------------|-------|---------|
| Solder / A souder | PT00A | 45100A |
| Crimp / A sertir | - | 45100RA |

Square flange receptacle with intermediate backshell.
Embase à collerette carrée avec raccord intermédiaire.

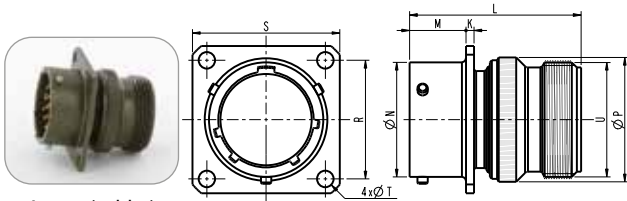

A type (solder)
Type A (à souder)

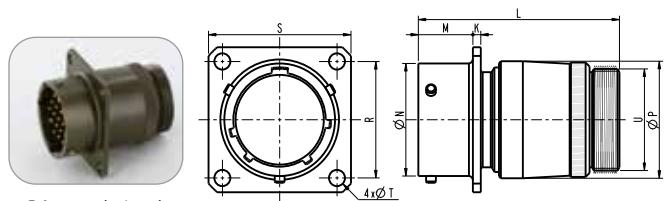

RA type (crimp)
Type RA (à sertir)

| Shell size Taille du boîtier | K max. | L max. | | M | Ø N | Ø P max. | | R | S | Ø T ± 0.1 | U Thread (class 2A) Filetage U (classe 2A) | |
|---------------------------------|--------|--------|------|-------|-------|----------|------|-------|------|--------------|---|-----------------|
| | | A | RA | | | A | RA | | | | A type (solder) | RA type (crimp) |
| 8 | 1.57 | 34.3 | 41.5 | 10.95 | 12.01 | 14.7 | 13.9 | 15.09 | 20.6 | 3.2 | 0.5000-28UNEF | 0.4375-28UNEF |
| 10 | 1.57 | 34.3 | 41.5 | 10.95 | 14.99 | 17.9 | 17.1 | 18.26 | 23.8 | 3.2 | 0.6250-24UNEF | 0.5625-24UNEF |
| 12 | 1.57 | 34.3 | 41.5 | 10.95 | 19.05 | 20.9 | 20.3 | 20.62 | 26.2 | 3.2 | 0.7500-20UNEF | 0.6875-24UNEF |
| 14 | 1.57 | 34.3 | 41.5 | 10.95 | 22.23 | 24.3 | 23.3 | 23.01 | 28.6 | 3.2 | 0.8750-20UNEF | 0.8125-20UNEF |
| 16 | 1.57 | 34.3 | 41.5 | 10.95 | 25.40 | 27.3 | 26.5 | 24.61 | 31.0 | 3.2 | 1.0000-20UNEF | 0.9375-20UNEF |
| 18 | 1.57 | 34.3 | 41.5 | 10.95 | 28.58 | 30.6 | 29.5 | 26.97 | 33.3 | 3.2 | 1.1875-18UNEF | 1.0625-18UNEF |
| 20 | 2.39 | 40.7 | 45.0 | 14.12 | 31.75 | 33.5 | 32.7 | 29.36 | 36.5 | 3.2 | 1.1875-18UNEF | 1.1875-18UNEF |
| 22 | 2.39 | 40.7 | 45.0 | 14.12 | 34.93 | 36.8 | 36.0 | 31.75 | 39.7 | 3.2 | 1.4375-18UNEF | 1.3125-18UNEF |
| 24 | 2.39 | 42.3 | 46.5 | 14.96 | 38.10 | 40.0 | 39.2 | 34.93 | 42.9 | 3.73 | 1.4375-18UNEF | 1.4375-18UNEF |

To mount the receptacle on the panel, please refer to page 58 for panel drilling and thickness.

Pour le montage des embases sur panneau, se référer à la page 58 pour le perçage et l'épaisseur des panneaux.

all dimensions are in mm

| | | | |
|-------------------|--------|--------|----------|
| Solder / A souder | PT00E | 45100E | - |
| Crimp / A sertir | PT00SE | 45100R | VG95328A |



Square flange receptacle with grommet backnut.
Embase à collerette carrée avec écrou serre-fils.

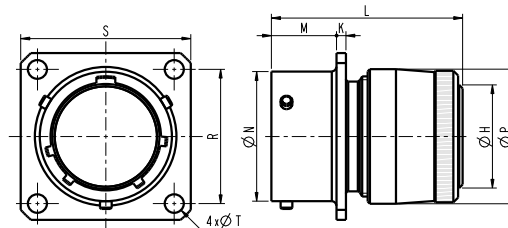

| Shell size Taille du boîtier | Ø H | K max. | L max. | M | Ø N | Ø P max. | R | S | Ø T ± 0.1 |
|---------------------------------|------|--------|--------|-------|-------|----------|-------|------|--------------|
| 8 | 9.3 | 1.57 | 32.7 | 10.95 | 12.01 | 13.9 | 15.09 | 20.6 | 3.2 |
| 10 | 12.3 | 1.57 | 32.7 | 10.95 | 14.99 | 17.1 | 18.26 | 23.8 | 3.2 |
| 12 | 15.2 | 1.57 | 32.7 | 10.95 | 19.05 | 20.3 | 20.62 | 26.2 | 3.2 |
| 14 | 18.5 | 1.57 | 32.7 | 10.95 | 22.23 | 23.3 | 23.01 | 28.6 | 3.2 |
| 16 | 21.7 | 1.57 | 32.7 | 10.95 | 25.40 | 26.5 | 24.61 | 31.0 | 3.2 |
| 18 | 24.2 | 1.57 | 32.7 | 10.95 | 28.58 | 29.5 | 26.97 | 33.3 | 3.2 |
| 20 | 27.4 | 2.39 | 34.2 | 14.12 | 31.75 | 32.7 | 29.36 | 36.5 | 3.2 |
| 22 | 30.6 | 2.39 | 34.2 | 14.12 | 34.93 | 36.0 | 31.75 | 39.7 | 3.2 |
| 24 | 33.8 | 2.39 | 35.8 | 14.96 | 38.10 | 39.2 | 34.93 | 42.9 | 3.73 |

| | | | |
|-------------------|-------------------------|-------------------|----------|
| Solder / A souder | PT00A (SR) / PT00E (SR) | 45100AC / 45100EC | - |
| Crimp / A sertir | PT00SE (SR) | 45100RC | VG95328B |



Square flange receptacle with cable clamp backshell.
Embase à collerette carrée avec raccord serre-câble.

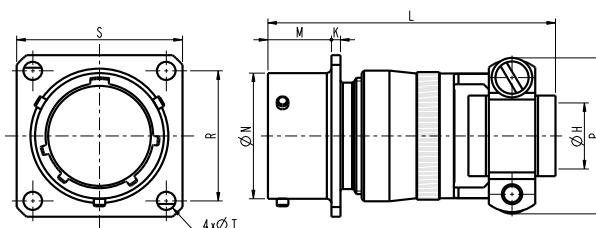

| Shell size Taille du boîtier | ØH | K max. | L max. | M | ØN | P max. | R | S | ØT ± 0.1 |
|---------------------------------|------|--------|--------|-------|-------|--------|-------|------|-------------|
| 8 | 3.2 | 1.57 | 49.0 | 10.95 | 12.01 | 19.3 | 15.09 | 20.6 | 3.2 |
| 10 | 4.8 | 1.57 | 49.0 | 10.95 | 14.99 | 20.8 | 18.26 | 23.8 | 3.2 |
| 12 | 7.9 | 1.57 | 49.0 | 10.95 | 19.05 | 24.0 | 20.62 | 26.2 | 3.2 |
| 14 | 9.5 | 1.57 | 49.0 | 10.95 | 22.23 | 27.2 | 23.01 | 28.6 | 3.2 |
| 16 | 12.7 | 1.57 | 52.4 | 10.95 | 25.40 | 28.8 | 24.61 | 31.0 | 3.2 |
| 18 | 15.9 | 1.57 | 52.4 | 10.95 | 28.58 | 35.1 | 26.97 | 33.3 | 3.2 |
| 20 | 15.9 | 2.39 | 54.8 | 14.12 | 31.75 | 35.1 | 29.36 | 36.5 | 3.2 |
| 22 | 19.1 | 2.39 | 54.8 | 14.12 | 34.93 | 39.9 | 31.75 | 39.7 | 3.2 |
| 24 | 20.3 | 2.39 | 56.4 | 14.96 | 38.10 | 42.3 | 34.93 | 42.9 | 3.73 |

Note: for the version without grommet A + SR (PT) or AC (451), use the nylon ring delivered with the cable clamp to screw your backshell at the rear of the receptacle.

Pour la version sans serre-fil A + SR (PT) ou AC (451), utiliser la bague en nylon livrée avec le serre-câble pour visser votre raccord à l'arrière de l'embase.

To mount the receptacle on the panel, please refer to page 58 for panel drilling and thickness.

Pour le montage des embases sur panneau, se référer à la page 58 pour le perçage et l'épaisseur des panneaux.

| | | |
|-------------------|--------|--------|
| Solder / A souder | PT00 W | 45100J |
| Crimp / A sertir | - | - |

Square flange receptacle with metal sealing gland backshell.
Embase à collerette carrée avec raccord presse-étoupe métallique.

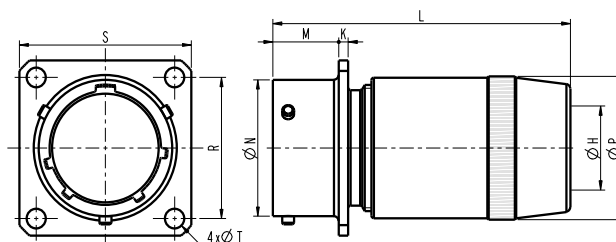

| Shell size <i>Taille du boîtier</i> | Ø H | | K max. | L max. | M | Ø N | Ø P max. | R | S | Ø T ± 0.1 |
|--|------|------|--------|--------|-------|-------|----------|-------|------|--------------|
| | min. | max. | | | | | | | | |
| 8 | 4.3 | 5.8 | 1.57 | 40.8 | 10.95 | 12.01 | 13.6 | 15.09 | 20.6 | 3.2 |
| 10 | 5.2 | 7.9 | 1.57 | 41.8 | 10.95 | 14.99 | 16.8 | 18.26 | 23.8 | 3.2 |
| 12 | 8.6 | 11.2 | 1.57 | 45.4 | 10.95 | 19.05 | 20.3 | 20.62 | 26.2 | 3.2 |
| 14 | 10.6 | 13.7 | 1.57 | 50.3 | 10.95 | 22.23 | 23.6 | 23.01 | 28.6 | 3.2 |
| 16 | 14.0 | 15.6 | 1.57 | 55.8 | 10.95 | 25.40 | 26.8 | 24.61 | 31.0 | 3.2 |
| 18 | 15.2 | 17.1 | 1.57 | 61.6 | 10.95 | 28.58 | 30.0 | 26.97 | 33.3 | 3.2 |
| 20 | 16.1 | 19.0 | 2.39 | 72.7 | 14.12 | 31.75 | 33.3 | 29.36 | 36.5 | 3.2 |
| 22 | 17.0 | 21.5 | 2.39 | 76.8 | 14.12 | 34.93 | 36.5 | 31.75 | 39.7 | 3.2 |
| 24 | 18.8 | 22.7 | 2.39 | 82.5 | 14.96 | 38.10 | 39.7 | 34.93 | 42.9 | 3.73 |

| | | |
|-------------------|------------|---------|
| Solder / A souder | PT00E (J) | 45100T |
| Crimp / A sertir | PT00SE (J) | 45100RT |

Square flange receptacle with backnut for heatshrink moulded piece.
Embase à collerette carrée avec raccord pour pièce moulée thermorétractable.

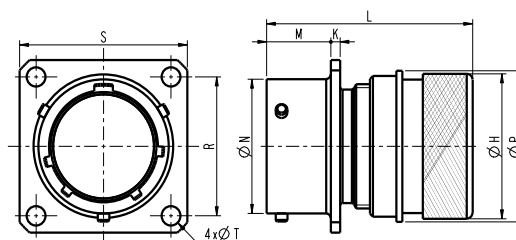

| Shell size <i>Taille du boîtier</i> | Ø H | K max. | L max. | M | Ø N | Ø P max. | R | S | Ø T ± 0.1 |
|--|------|--------|--------|-------|-------|----------|-------|------|--------------|
| 8 | 15.6 | 1.57 | 35.0 | 10.95 | 12.01 | 15.4 | 15.09 | 20.6 | 3.2 |
| 10 | 18.4 | 1.57 | 35.0 | 10.95 | 14.99 | 18.6 | 18.26 | 23.8 | 3.2 |
| 12 | 23.7 | 1.57 | 35.0 | 10.95 | 19.05 | 21.8 | 20.62 | 26.2 | 3.2 |
| 14 | 24.5 | 1.57 | 35.0 | 10.95 | 22.23 | 25.0 | 23.01 | 28.6 | 3.2 |
| 16 | 29.8 | 1.57 | 37.5 | 10.95 | 25.40 | 28.2 | 24.61 | 31.0 | 3.2 |
| 18 | 32.0 | 1.57 | 37.5 | 10.95 | 28.58 | 31.3 | 26.97 | 33.3 | 3.2 |
| 20 | 36.1 | 2.39 | 47.5 | 14.12 | 31.75 | 34.5 | 29.36 | 36.5 | 3.2 |
| 22 | 38.5 | 2.39 | 47.5 | 14.12 | 34.93 | 37.7 | 31.75 | 39.7 | 3.2 |
| 24 | 41.5 | 2.39 | 47.5 | 14.96 | 38.10 | 40.9 | 34.93 | 42.9 | 3.73 |

To mount the receptacle on the panel, please refer to page 58 for panel drilling and thickness.

Pour le montage des embases sur panneau, se référer à la page 58 pour le perçage et l'épaisseur des panneaux.

all dimensions are in mm

| | | |
|-------------------|--------|---------|
| Solder / A souder | PT00P | 45100P |
| Crimp / A sertir | PT00SP | 45100RP |

Square flange receptacle with straight backshell for potting.
Embase à collerette carrée avec raccord pour potting.

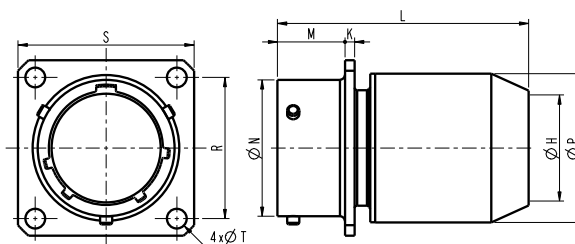

| Shell size Taille du boîtier | Ø H | K max. | L max. | | M | Ø N | Ø P max. | R | S | Ø T ± 0.1 |
|---------------------------------|------|--------|--------|-------|-------|-------|----------|-------|------|--------------|
| | | | Solder | Crimp | | | | | | |
| 8 | 8.3 | 1.57 | 32 | 44 | 10.95 | 12.01 | 14.9 | 15.09 | 20.6 | 3.2 |
| 10 | 11.3 | 1.57 | 32 | 44 | 10.95 | 14.99 | 18.1 | 18.26 | 23.8 | 3.2 |
| 12 | 14.2 | 1.57 | 32 | 44 | 10.95 | 19.05 | 21.3 | 20.62 | 26.2 | 3.2 |
| 14 | 17.3 | 1.57 | 32 | 44 | 10.95 | 22.23 | 24.5 | 23.01 | 28.6 | 3.2 |
| 16 | 20.5 | 1.57 | 32 | 44 | 10.95 | 25.40 | 27.7 | 24.61 | 31.0 | 3.2 |
| 18 | 23.1 | 1.57 | 32 | 44 | 10.95 | 28.58 | 30.8 | 26.97 | 33.3 | 3.2 |
| 20 | 26.3 | 2.39 | 36 | 48 | 14.12 | 31.75 | 34.0 | 29.36 | 36.5 | 3.2 |
| 22 | 29.4 | 2.39 | 36 | 48 | 14.12 | 34.93 | 37.2 | 31.75 | 39.7 | 3.2 |
| 24 | 32.6 | 2.39 | 37 | 49 | 14.96 | 38.10 | 40.3 | 34.93 | 42.9 | 3.73 |

| | | | |
|-------------------|-------------|---------|----------|
| Solder / A souder | PT00E (SQ) | 45100G | - |
| Crimp / A sertir | PT00SE (SQ) | 45100RG | VG95328R |

Square flange receptacle with SQ braid clamping backshell
Embase à collerette carrée avec raccord SQ pour reprise de tresse

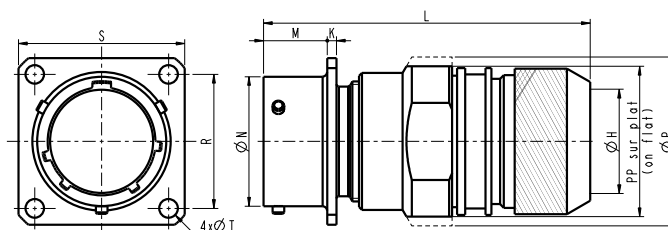

| Shell size Taille du boîtier | Ø H | K | L max. | M | Ø N | Ø P | PP | R | S | Ø T ± 0.1 |
|---------------------------------|------|------|--------|-------|-------|-----|------|-------|------|--------------|
| 8 | 6.7 | 1.57 | 53 | 10.95 | 12.01 | 20 | 16.8 | 15.09 | 20.6 | 3.2 |
| 10 | 9.2 | 1.57 | 53 | 10.95 | 14.99 | 24 | 20.8 | 18.26 | 23.8 | 3.2 |
| 12 | 12.2 | 1.57 | 54 | 10.95 | 19.05 | 26 | 22.8 | 20.62 | 26.2 | 3.2 |
| 14 | 15.2 | 1.57 | 54 | 10.95 | 22.23 | 29 | 25.8 | 23.01 | 28.6 | 3.2 |
| 16 | 18.3 | 1.57 | 54 | 10.95 | 25.40 | 32 | 28.8 | 24.61 | 31.0 | 3.2 |
| 18 | 20.0 | 1.57 | 54 | 10.95 | 28.58 | 35 | 31.8 | 26.97 | 33.3 | 3.2 |
| 20 | 23.0 | 2.39 | 58 | 14.12 | 31.75 | 38 | 35.8 | 29.36 | 36.5 | 3.2 |
| 22 | 26.0 | 2.39 | 58 | 14.12 | 34.93 | 42 | 38.8 | 31.75 | 39.7 | 3.2 |
| 24 | 28.8 | 2.39 | 60 | 14.96 | 38.10 | 45 | 41.8 | 34.93 | 42.9 | 3.73 |

SQ backshell description: see page 35

Description du raccord SQ : Voir page 35

To mount the receptacle on the panel, please refer to page 58 for panel drilling and thickness.

Pour le montage des embases sur panneau, se référer à la page 58 pour le perçage et l'épaisseur des panneaux.

all dimensions are in mm

Inline receptacles 01 type

Prolongateurs type 01

| | | |
|-------------------|-------|---------|
| Solder / A souder | PT01A | 45101A |
| Crimp / A sertir | - | 45101RA |

Inline receptacle with intermediate backshell.
Prolongateur avec raccord intermédiaire.

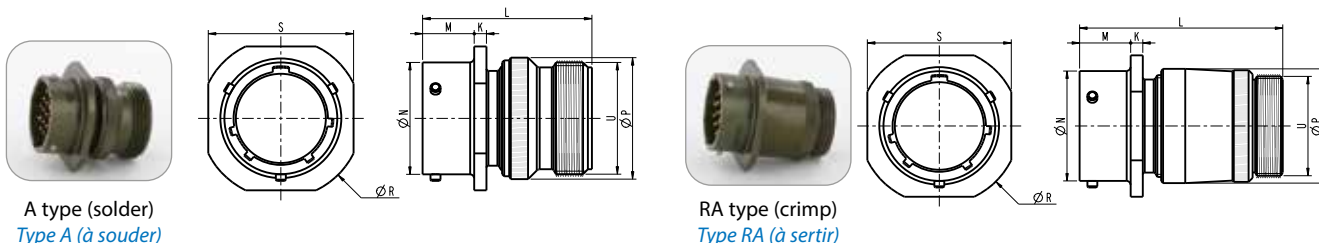

| Shell size Taille du boîtier | K | L max | | M | Ø N | Ø P | | Ø R | S | U Thread (class 2A) Filetage U (classe 2A) | |
|---------------------------------|-----|-------|------|-------|-------|------|------|------|------|---|-----------------|
| | | A | RA | | | A | RA | | | A type (solder) | RA type (crimp) |
| 8 | 2.4 | 34.3 | 41.5 | 10.16 | 12.01 | 14,7 | 13.9 | 23.8 | 20.6 | 0.5000-28UNEF | 0.4375-28UNEF |
| 10 | 2.4 | 34.3 | 41.5 | 10.16 | 14.99 | 17,9 | 17.1 | 27.0 | 23.8 | 0.6250-24UNEF | 0.5625-24UNEF |
| 12 | 2.4 | 34.3 | 41.5 | 10.16 | 19.05 | 20,9 | 20.3 | 29.4 | 26.2 | 0.7500-20UNEF | 0.6875-24UNEF |
| 14 | 2.4 | 34.3 | 41.5 | 10.16 | 22.23 | 24,3 | 23.3 | 31.8 | 28.6 | 0.8750-20UNEF | 0.8125-20UNEF |
| 16 | 2.4 | 34.3 | 41.5 | 10.16 | 25.40 | 27,3 | 26.5 | 34.1 | 31.0 | 1.0000-20UNEF | 0.9375-20UNEF |
| 18 | 2.4 | 34.3 | 41.5 | 10.16 | 28.58 | 30,6 | 29.5 | 36.5 | 33.3 | 1.1875-18UNEF | 1.0625-18UNEF |
| 20 | 2.9 | 40.7 | 45.0 | 13.59 | 31.75 | 33,5 | 32.7 | 39.7 | 36.5 | 1.1875-18UNEF | 1.1875-18UNEF |
| 22 | 2.9 | 40.7 | 45.0 | 13.59 | 34.93 | 36,8 | 36.0 | 42.9 | 39.7 | 1.4375-18UNEF | 1.3125-18UNEF |
| 24 | 2.9 | 42.3 | 46.5 | 14.43 | 38.10 | 40,0 | 39.2 | 46.0 | 42.9 | 1.4375-18UNEF | 1.4375-18UNEF |

| | | |
|-------------------|--------|--------|
| Solder / A souder | PT01E | 45101E |
| Crimp / A sertir | PT01SE | 45101R |

Inline receptacle with grommet backnut.
Prolongateur avec écrou serre-fils.

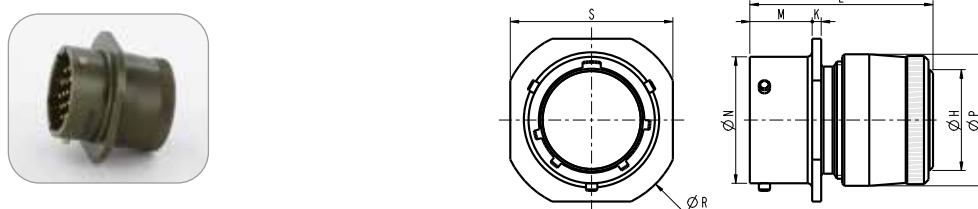

| Shell size Taille du boîtier | Ø H | K | L max. | M | Ø N | Ø P max. | Ø R | S |
|---------------------------------|------|-----|--------|-------|-------|----------|------|------|
| 8 | 9.3 | 2.4 | 32.7 | 10.16 | 12.01 | 13.9 | 23.8 | 20.6 |
| 10 | 12.3 | 2.4 | 32.7 | 10.16 | 14.99 | 17.1 | 27.0 | 23.8 |
| 12 | 15.2 | 2.4 | 32.7 | 10.16 | 19.05 | 20.3 | 29.4 | 26.2 |
| 14 | 18.5 | 2.4 | 32.7 | 10.16 | 22.23 | 23.3 | 31.8 | 28.6 |
| 16 | 21.7 | 2.4 | 32.7 | 10.16 | 25.40 | 26.5 | 34.1 | 31.0 |
| 18 | 24.2 | 2.4 | 32.7 | 10.16 | 28.58 | 29.5 | 36.5 | 33.3 |
| 20 | 27.4 | 2.9 | 34.2 | 13.59 | 31.75 | 32.7 | 39.7 | 36.5 |
| 22 | 30.6 | 2.9 | 34.2 | 13.59 | 34.93 | 36.0 | 42.9 | 39.7 |
| 24 | 33.8 | 2.9 | 35.8 | 14.43 | 38.10 | 39.2 | 46.0 | 42.9 |

| | | |
|-------------------|-------------------------|-------------------|
| Solder / A souder | PT01A (SR) / PT01E (SR) | 45101AC / 45101EC |
| Crimp / A sertir | PT01SE (SR) | 45101RC |

Inline receptacle with cable clamp backshell.
Prolongateur avec raccord serre-câble.

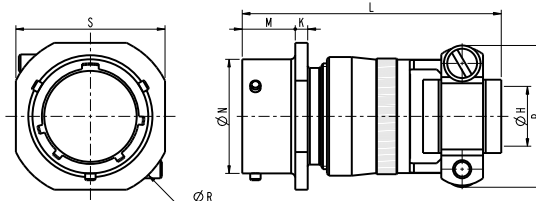

| Shell size Taille du boîtier | Ø H | K | L max. | M | Ø N | P max. | Ø R | S |
|---------------------------------|------|-----|--------|-------|-------|--------|------|------|
| 8 | 3.2 | 2.4 | 49.0 | 10.16 | 12.01 | 19.3 | 23.8 | 20.6 |
| 10 | 4.8 | 2.4 | 49.0 | 10.16 | 14.99 | 20.8 | 27.0 | 23.8 |
| 12 | 7.9 | 2.4 | 49.0 | 10.16 | 19.05 | 24.0 | 29.4 | 26.2 |
| 14 | 9.5 | 2.4 | 49.0 | 10.16 | 22.23 | 27.2 | 31.8 | 28.6 |
| 16 | 12.7 | 2.4 | 52.4 | 10.16 | 25.40 | 28.8 | 34.1 | 31.0 |
| 18 | 15.9 | 2.4 | 52.4 | 10.16 | 28.58 | 35.1 | 36.5 | 33.3 |
| 20 | 15.9 | 2.9 | 54.8 | 13.59 | 31.75 | 35.1 | 39.7 | 36.5 |
| 22 | 19.1 | 2.9 | 54.8 | 13.59 | 34.93 | 39.9 | 42.9 | 39.7 |
| 24 | 20.3 | 2.9 | 56.4 | 14.43 | 38.10 | 42.3 | 46.0 | 42.9 |

Note: for the version without grommet A + SR (PT) or AC (451), use the nylon ring delivered with the cable clamp to screw your backshell at the rear of the receptacle.

Pour la version sans serre-fil A + SR (PT) ou AC (451), utiliser la bague en nylon livrée avec le serre-câble pour visser votre raccord à l'arrière de l'embase.

| | | |
|-------------------|-------|--------|
| Solder / A souder | PT01W | 45101J |
| Crimp / A sertir | - | - |

Inline receptacle with metal sealing gland backshell.
Prolongateur avec raccord presse-étoupe métallique.

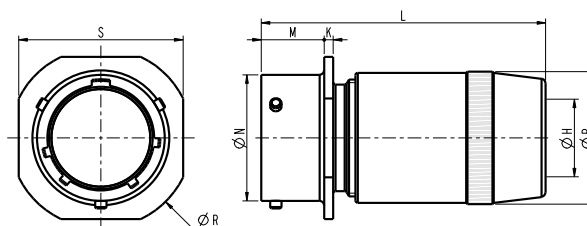

| Shell size Taille du boîtier | Ø H | | K | L max. | M | Ø N | Ø P max. | Ø R | S |
|---------------------------------|------|------|-----|--------|-------|-------|----------|------|------|
| | min. | max. | | | | | | | |
| 8 | 4.3 | 5.8 | 2.4 | 40.8 | 10.16 | 12.01 | 13.6 | 23.8 | 20.6 |
| 10 | 5.2 | 7.9 | 2.4 | 41.8 | 10.16 | 14.99 | 16.8 | 27.0 | 23.8 |
| 12 | 8.6 | 11.2 | 2.4 | 45.4 | 10.16 | 19.05 | 20.3 | 29.4 | 26.2 |
| 14 | 10.6 | 13.7 | 2.4 | 50.3 | 10.16 | 22.23 | 23.6 | 31.8 | 28.6 |
| 16 | 14.0 | 15.6 | 2.4 | 55.8 | 10.16 | 25.40 | 26.8 | 34.1 | 31.0 |
| 18 | 15.2 | 17.1 | 2.4 | 61.6 | 10.16 | 28.58 | 30.0 | 36.5 | 33.3 |
| 20 | 16.1 | 19.0 | 2.9 | 72.7 | 13.59 | 31.75 | 33.3 | 39.7 | 36.5 |
| 22 | 17.0 | 21.5 | 2.9 | 76.8 | 13.59 | 34.93 | 36.5 | 42.9 | 39.7 |
| 24 | 18.8 | 22.7 | 2.9 | 82.5 | 14.43 | 38.10 | 39.7 | 46.0 | 42.9 |

| | | |
|-------------------|-------------|-------------|
| Solder / A souder | PT01A (PG) | 45101A (PG) |
| Crimp / A sertir | PT01SE (PG) | 45101R (PG) |

Inline receptacle with straight adaptor terminated by a PG type plastic sealing gland.

Prolongateur avec raccord intermédiaire raccordé à un presse-étoupe plastique type PG.

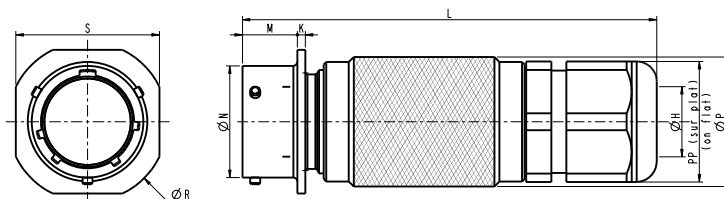

| Shell size <i>Taille du boîtier</i> | Ø H min-max | K | L max. | M | Ø N | Ø P max. | PG | PP | Ø R | S |
|--|----------------|-----|--------|-------|-------|----------|--------|----|------|------|
| 8 | 2.5 - 6.5 | 2.4 | 75.5 | 10.16 | 12.01 | 16.6 | PG7 | 15 | 23.8 | 20.6 |
| 10 | 3.5 - 8 | 2.4 | 79.5 | 10.16 | 14.99 | 19.5 | PG9 | 19 | 27.0 | 23.8 |
| 12 | 4 - 10 | 2.4 | 81.5 | 10.16 | 19.05 | 22.8 | PG11 | 22 | 29.4 | 26.2 |
| 14 | 5 - 12 | 2.4 | 88.5 | 10.16 | 22.23 | 25.8 | PG13.5 | 24 | 31.8 | 28.6 |
| 16 | 9 - 14 | 2.4 | 90.5 | 10.16 | 25.40 | 28.9 | PG16 | 27 | 34.1 | 31.0 |
| 18 | 9 - 14 | 2.4 | 95.5 | 10.16 | 28.58 | 32.0 | PG16 | 27 | 36.5 | 33.3 |
| 20 | 9 - 14 | 2.9 | 101 | 13.59 | 31.75 | 35.2 | PG16 | 27 | 39.7 | 36.5 |
| 22 | 13 - 18 | 2.9 | 110 | 13.59 | 34.93 | 38.3 | PG21 | 33 | 42.9 | 39.7 |
| 24 | 13 - 18 | 2.9 | 111.5 | 14.43 | 38.10 | 41.6 | PG21 | 33 | 46.0 | 42.9 |

| | | |
|-------------------|------------|---------|
| Solder / A souder | PT01E (J) | 45101T |
| Crimp / A sertir | PT01SE (J) | 45101RT |

Inline receptacle with backnut for heatshrink moulded piece.

Prolongateur avec raccord pour pièce moulée thermorétractable.

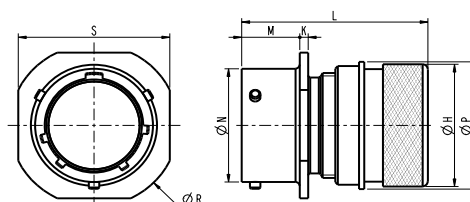

| Shell size <i>Taille du boîtier</i> | Ø H max. | K | Lmax. | M | Ø N | Ø P max. | Ø R | S |
|--|----------|-----|-------|-------|-------|----------|------|------|
| 8 | 15.6 | 2.4 | 35.0 | 10.16 | 12.01 | 15.4 | 23.8 | 20.6 |
| 10 | 18.4 | 2.4 | 35.0 | 10.16 | 14.99 | 18.6 | 27.0 | 23.8 |
| 12 | 23.7 | 2.4 | 35.0 | 10.16 | 19.05 | 21.8 | 29.4 | 26.2 |
| 14 | 24.5 | 2.4 | 35.0 | 10.16 | 22.23 | 25.0 | 31.8 | 28.6 |
| 16 | 29.8 | 2.4 | 37.5 | 10.16 | 25.40 | 28.2 | 34.1 | 31.0 |
| 18 | 32.0 | 2.4 | 37.5 | 10.16 | 28.58 | 31.3 | 36.5 | 33.3 |
| 20 | 36.1 | 2.9 | 47.5 | 13.59 | 31.75 | 34.5 | 39.7 | 36.5 |
| 22 | 38.5 | 2.9 | 47.5 | 13.59 | 34.93 | 37.7 | 42.9 | 39.7 |
| 24 | 41.5 | 2.9 | 47.5 | 14.43 | 38.10 | 40.9 | 46.0 | 42.9 |

| | | |
|-------------------|--------|---------|
| Solder / A souder | PT01P | 45101P |
| Crimp / A sertir | PT01SP | 45101RP |

Inline receptacle with straight backshell for potting.
Prolongateur avec raccord pour potting.

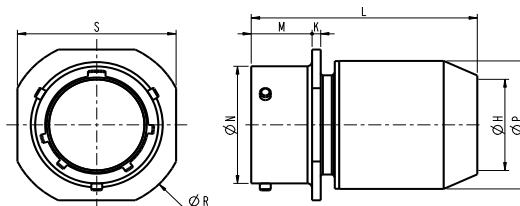

| Shell size Taille du boîtier | Ø H | K | L max. | | M | Ø N | Ø P max. | Ø R | S |
|---------------------------------|------|-----|--------|-------|-------|-------|----------|------|------|
| | | | Solder | Crimp | | | | | |
| 8 | 8.3 | 2.4 | 32 | 44 | 10.16 | 12.01 | 14.9 | 23.8 | 20.6 |
| 10 | 11.3 | 2.4 | 32 | 44 | 10.16 | 14.99 | 18.1 | 27.0 | 23.8 |
| 12 | 14.2 | 2.4 | 32 | 44 | 10.16 | 19.05 | 21.3 | 29.4 | 26.2 |
| 14 | 17.3 | 2.4 | 32 | 44 | 10.16 | 22.23 | 24.5 | 31.8 | 28.6 |
| 16 | 20.5 | 2.4 | 32 | 44 | 10.16 | 25.40 | 27.7 | 34.1 | 31.0 |
| 18 | 23.1 | 2.4 | 32 | 44 | 10.16 | 28.58 | 30.8 | 36.5 | 33.3 |
| 20 | 26.3 | 2.9 | 36 | 48 | 13.59 | 31.75 | 34.0 | 39.7 | 36.5 |
| 22 | 29.4 | 2.9 | 36 | 48 | 13.59 | 34.93 | 37.2 | 42.9 | 39.7 |
| 24 | 32.6 | 2.9 | 37 | 49 | 14.43 | 38.10 | 40.3 | 46.0 | 42.9 |

| | | |
|-------------------|-----------------|-------------------|
| Solder / A souder | PT01EK / PT01KM | 45101EK / 45101KM |
| Crimp / A sertir | PT01SK | 45101SK |

Inline receptacle with rain proof or immersion proof sealing gland backshell with strong grip.
Prolongateur avec raccord presse-étoupe étanche au ruissellement ou à l'immersion.

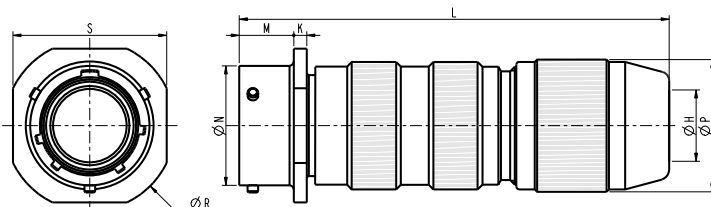

| Shell size Taille du boîtier | K | L max. | | M | Ø N | Ø P max. | Ø R | S |
|---------------------------------|-----|---------|------------|-------|-------|----------|------|------|
| | | EK type | KM/SK type | | | | | |
| 8 | 2.4 | 71.5 | 81.5 | 10.16 | 12.01 | 17.0 | 23.8 | 20.6 |
| 10 | 2.4 | 71.5 | 81.5 | 10.16 | 14.99 | 19.0 | 27.0 | 23.8 |
| 12 | 2.4 | 71.5 | 81.5 | 10.16 | 19.05 | 25.0 | 29.4 | 26.2 |
| 14 | 2.4 | 79.5 | 94.5 | 10.16 | 22.23 | 27.0 | 31.8 | 28.6 |
| 16 | 2.4 | 79.5 | 94.5 | 10.16 | 25.40 | 28.5 | 34.1 | 31.0 |
| 18 | 2.4 | 79.5 | 94.5 | 10.16 | 28.58 | 31.5 | 36.5 | 33.3 |
| 20 | 2.9 | 91.5 | 107 | 13.59 | 31.75 | 34.5 | 39.7 | 36.5 |
| 22 | 2.9 | 94 | 109.5 | 13.59 | 34.93 | 34.5 | 42.9 | 39.7 |
| 24 | 2.9 | 95 | 110 | 14.43 | 38.10 | 36.0 | 46.0 | 42.9 |

Please refer to end of page 34 for dimension H depending on the gasket number.

Veillez vous référer au bas de la page 34 pour la dimension H selon le numéro de joint utilisé.

| | | |
|-------------------|-------------|---------|
| Solder / A souder | PT01E (SQ) | 45101G |
| Crimp / A sertir | PT01SE (SQ) | 45101RG |

Inline receptacle with SQ braid clamping backshell.
Prolongateur avec raccord SQ pour reprise de tresse.

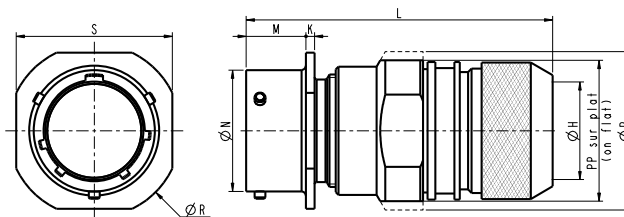

| Shell size Taille du boîtier | Ø H | K | L max. | M | Ø N | Ø P | PP | Ø R | S |
|---------------------------------|------|-----|--------|-------|-------|-----|------|------|------|
| 8 | 6.7 | 2.4 | 53 | 10.16 | 12.01 | 20 | 16.8 | 23.8 | 20.6 |
| 10 | 9.2 | 2.4 | 53 | 10.16 | 14.99 | 24 | 20.8 | 27.0 | 23.8 |
| 12 | 12.2 | 2.4 | 54 | 10.16 | 19.05 | 26 | 22.8 | 29.4 | 26.2 |
| 14 | 15.2 | 2.4 | 54 | 10.16 | 22.23 | 29 | 25.8 | 31.8 | 28.6 |
| 16 | 18.3 | 2.4 | 54 | 10.16 | 25.40 | 32 | 28.8 | 34.1 | 31.0 |
| 18 | 20.0 | 2.4 | 54 | 10.16 | 28.58 | 35 | 31.8 | 36.5 | 33.3 |
| 20 | 23.0 | 2.9 | 58 | 13.59 | 31.75 | 38 | 35.8 | 39.7 | 36.5 |
| 22 | 26.0 | 2.9 | 58 | 13.59 | 34.93 | 42 | 38.8 | 42.9 | 39.7 |
| 24 | 28.8 | 2.9 | 60 | 14.43 | 38.10 | 45 | 41.8 | 46.0 | 42.9 |

SQ backshell description: see page 35
Description du raccord SQ : Voir page 35

Jam nut receptacles 07 types Embases à écrou type 07

| | | |
|-------------------|---------------|--------|
| Solder / A souder | PT07A / PT07C | 45107A |
| Crimp / A sertir | - | - |

Jam nut receptacle.
Embase à fixation par écrou.

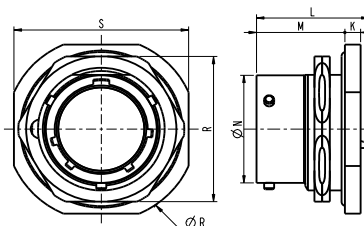

| Shell size Taille du boîtier | K ± 0.5 | L max. | M ± 0.13 | Ø N ⁺⁰ _{-0.13} | R ± 0.30 | S ± 0.30 |
|---------------------------------|---------|--------|----------|------------------------------------|----------|----------|
| 8 | 3.2 | 23.0 | 17.7 | 12.01 | 19 | 23.8 |
| 10 | 3.2 | 23.0 | 17.7 | 14.99 | 22 | 27.0 |
| 12 | 3.2 | 23.0 | 17.7 | 19.05 | 27 | 31.8 |
| 14 | 3.2 | 23.0 | 17.7 | 22.23 | 30 | 34.9 |
| 16 | 3.2 | 23.0 | 17.7 | 25.40 | 33 | 38.1 |
| 18 | 3.2 | 23.0 | 17.7 | 28.58 | 37 | 41.3 |
| 20 | 4.0 | 29.0 | 22.5 | 31.75 | 40 | 46.0 |
| 22 | 4.0 | 29.0 | 22.5 | 34.93 | 43 | 49.2 |
| 24 | 4.0 | 29.0 | 23.3 | 38.10 | 46 | 52.4 |

To mount the receptacle on the panel, please refer to page 62 for panel drilling and thickness.
Pour le montage des embases sur panneau, se référer à la page 62 pour le perçage et l'épaisseur des panneaux.

all dimensions are in mm

| | | | |
|-------------------|--------|--------|----------|
| Solder / A souder | PT07E | 45107E | - |
| Crimp / A sertir | PT07SE | 45107R | VG95328D |



Jam nut receptacle with grommet backnut.

Embase à fixation par écrou avec écrou serre-fils.

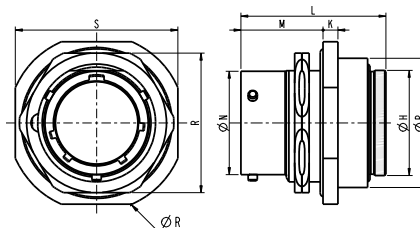

| Shell size <i>Taille du boîtier</i> | Ø H | K | L max. | M | Ø N | Ø P max. | R | Ø R | S |
|--|------|-----|--------|------|-------|----------|----|-----|------|
| 8 | 16.4 | 3.2 | 35.0 | 17.7 | 12.01 | 18.5 | 19 | | 23.8 |
| 10 | 19.6 | 3.2 | 35.0 | 17.7 | 14.99 | 21.6 | 22 | | 27.0 |
| 12 | 22.6 | 3.2 | 35.0 | 17.7 | 19.05 | 24.8 | 27 | | 31.8 |
| 14 | 25.8 | 3.2 | 35.0 | 17.7 | 22.23 | 28.0 | 30 | | 34.9 |
| 16 | 28.8 | 3.2 | 35.0 | 17.7 | 25.40 | 31.2 | 33 | | 38.1 |
| 18 | 32.0 | 3.2 | 35.0 | 17.7 | 28.58 | 34.3 | 37 | | 41.3 |
| 20 | 38.2 | 4.0 | 41.2 | 22.5 | 31.75 | 38.3 | 40 | | 46.0 |
| 22 | 41.4 | 4.0 | 41.2 | 22.5 | 34.93 | 41.5 | 43 | | 49.2 |
| 24 | 44.4 | 4.0 | 42.8 | 23.3 | 38.10 | 44.7 | 46 | | 52.4 |

| | | | |
|-------------------|-------------|---------|----------|
| Solder / A souder | PT07E (SR) | 45107EC | - |
| Crimp / A sertir | PT07SE (SR) | 45107RC | VG95328E |



Jam nut receptacle with cable clamp backshell.

Embase à fixation par écrou avec raccord serre-câble.

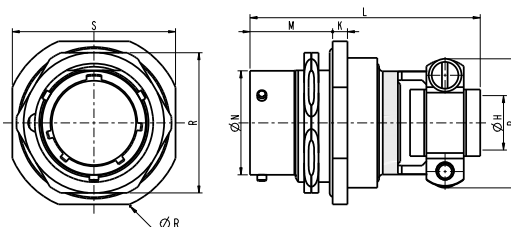

| Shell size <i>Taille du boîtier</i> | Ø H | K | L max. | M | Ø N | P max. | R | Ø R | S |
|--|------|-----|--------|------|-------|--------|----|-----|------|
| 8 | 3.2 | 3.2 | 49.5 | 17.7 | 12.01 | 19.3 | 19 | | 23.8 |
| 10 | 4.8 | 3.2 | 49.5 | 17.7 | 14.99 | 20.8 | 22 | | 27.0 |
| 12 | 7.9 | 3.2 | 50.0 | 17.7 | 19.05 | 24.0 | 27 | | 31.8 |
| 14 | 9.5 | 3.2 | 50.0 | 17.7 | 22.23 | 27.2 | 30 | | 34.9 |
| 16 | 12.7 | 3.2 | 52.6 | 17.7 | 25.40 | 28.8 | 33 | | 38.1 |
| 18 | 15.9 | 3.2 | 52.6 | 17.7 | 28.58 | 35.1 | 37 | | 41.3 |
| 20 | 15.9 | 4.0 | 56.5 | 22.5 | 31.75 | 35.1 | 40 | | 46.0 |
| 22 | 19.1 | 4.0 | 56.5 | 22.5 | 34.93 | 39.9 | 43 | | 49.2 |
| 24 | 20.3 | 4.0 | 58.2 | 23.3 | 38.10 | 42.3 | 46 | | 52.5 |

To mount the receptacle on the panel, please refer to page 62 for panel drilling and thickness.

Pour le montage des embases sur panneau, se référer à la page 62 pour le perçage et l'épaisseur des panneaux.

all dimensions are in mm

| | | |
|-------------------|--------|---------|
| Solder / A souder | PT07P | 45107P |
| Crimp / A sertir | PT07SP | 45107RP |

Jam nut receptacle with straight backshell for potting.

Embase à fixation par écrou avec raccord pour potting.

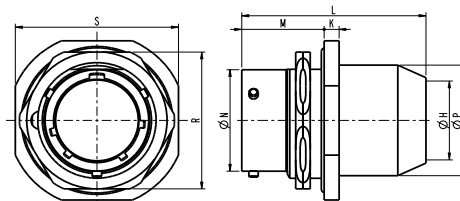

| Shell size Taille du boîtier | Ø H | K | L max. | | M | Ø N | Ø P max. | R | S |
|---------------------------------|------|-----|--------|-------|------|-------|----------|----|------|
| | | | Solder | Crimp | | | | | |
| 8 | 8.3 | 3.2 | 34.5 | 39.9 | 17.7 | 12.01 | 14.9 | 19 | 25.8 |
| 10 | 11.3 | 3.2 | 34.5 | 39.9 | 17.7 | 14.99 | 18.1 | 22 | 27.0 |
| 12 | 14.2 | 3.2 | 34.5 | 39.9 | 17.7 | 19.05 | 21.3 | 27 | 31.8 |
| 14 | 17.3 | 3.2 | 34.5 | 39.9 | 17.7 | 22.23 | 24.5 | 30 | 34.9 |
| 16 | 20.5 | 3.2 | 34.5 | 39.9 | 17.7 | 25.40 | 27.7 | 33 | 38.1 |
| 18 | 23.1 | 3.2 | 34.5 | 39.9 | 17.7 | 28.58 | 30.8 | 37 | 41.3 |
| 20 | 26.3 | 4.0 | 42.0 | 47.1 | 22.5 | 31.75 | 34.0 | 40 | 46.0 |
| 22 | 29.4 | 4.0 | 42.0 | 47.1 | 22.5 | 34.93 | 37.2 | 43 | 49.2 |
| 24 | 32.6 | 4.0 | 42.7 | 47.9 | 23.3 | 38.10 | 40.3 | 46 | 52.4 |

| | | |
|-------------------|-------------|---------|
| Solder / A souder | - | - |
| Crimp / A sertir | PT07SE (SQ) | 45107RG |

Jam nut receptacle with SQ braid clamping backshell.

Embase à fixation par écrou avec raccord SQ pour reprise de tresse.

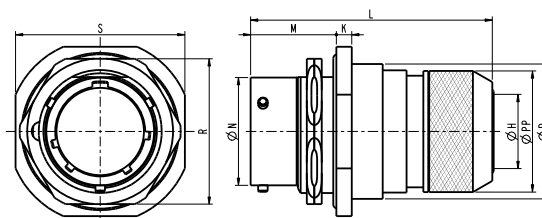

| Shell size Taille du boîtier | Ø H | K | L max. | M | Ø N | Ø P max. | Ø PP | R | S |
|---------------------------------|------|-----|--------|------|-------|----------|------|----|------|
| | | | | | | | | | |
| 10 | 9.2 | 3.2 | 49.6 | 17.7 | 14.99 | 21.6 | 18 | 22 | 27.0 |
| 12 | 12.2 | 3.2 | 50.6 | 17.7 | 19.05 | 24.8 | 22 | 27 | 31.8 |
| 14 | 15.2 | 3.2 | 50.6 | 17.7 | 22.23 | 28.0 | 25 | 30 | 34.9 |
| 16 | 18.3 | 3.2 | 50.6 | 17.7 | 25.40 | 31.2 | 28 | 33 | 38.1 |
| 18 | 20.0 | 3.2 | 50.6 | 17.7 | 28.58 | 34.3 | 32 | 37 | 41.3 |
| 20 | 23.0 | 4.0 | 55.8 | 22.5 | 31.75 | 38.3 | 34 | 40 | 46.0 |
| 22 | 26.0 | 4.0 | 55.8 | 22.5 | 34.93 | 41.5 | 38 | 43 | 49.2 |
| 24 | 28.8 | 4.0 | 57.5 | 23.3 | 38.10 | 44.7 | 41 | 46 | 52.4 |

To mount the receptacle on the panel, please refer to page 62 for panel drilling and thickness.

Pour le montage des embases sur panneau, se référer à la page 62 pour le perçage et l'épaisseur des panneaux.

all dimensions are in mm

Plug 06 type

Fiche type 06

| | | |
|-------------------|-------|---------|
| Solder / A souder | PT06A | 45106A |
| Crimp / A sertir | - | 45106RA |

Straight plug with intermediate backshell.
Fiche droite avec raccord intermédiaire.

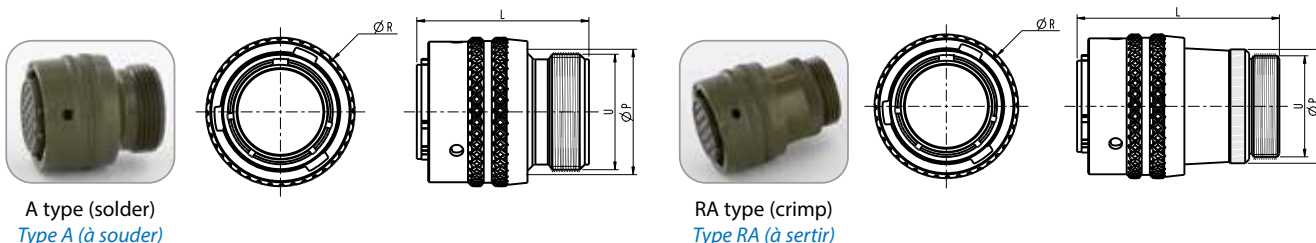

| Shell size Taille du boîtier | L max. | | Ø P | | Ø R | U Thread (class 2A) Filetage U (classe 2A) | |
|---------------------------------|--------|------|------|------|------|---|-----------------|
| | A | RA | A | RA | | A type (solder) | RA type (crimp) |
| 8 | 34.3 | 41.5 | 14,7 | 13.9 | 18.6 | 0.5000-28 UNEF | 0.4375-28 UNEF |
| 10 | 34.3 | 41.5 | 17,9 | 17.1 | 21.4 | 0.6250-24 UNEF | 0.5625-24 UNEF |
| 12 | 34.3 | 41.5 | 20,9 | 20.3 | 25.8 | 0.7500-20 UNEF | 0.6875-24 UNEF |
| 14 | 34.3 | 41.5 | 24,3 | 23.3 | 29.0 | 0.8750-20 UNEF | 0.8125-20 UNEF |
| 16 | 34.3 | 41.5 | 27,3 | 26.5 | 32.2 | 1.0000-20 UNEF | 0.9375-20 UNEF |
| 18 | 34.3 | 41.5 | 30,6 | 29.5 | 34.9 | 1.1875-18 UNEF | 1.0625-18 UNEF |
| 20 | 40.7 | 45.0 | 33,5 | 32.7 | 38.5 | 1.1875-18 UNEF | 1.1875-18 UNEF |
| 22 | 40.7 | 45.0 | 36,8 | 36.0 | 41.7 | 1.4375-18 UNEF | 1.3125-18 UNEF |
| 24 | 42.3 | 46.5 | 40,0 | 39.2 | 44.7 | 1.4375-18 UNEF | 1.4375-18 UNEF |

| | | |
|-------------------|--------|--------|
| Solder / A souder | PT06E | 45106E |
| Crimp / A sertir | PT06SE | 45106R |

Straight plug with grommet backnut.
Fiche droite avec écrou serre-fils.

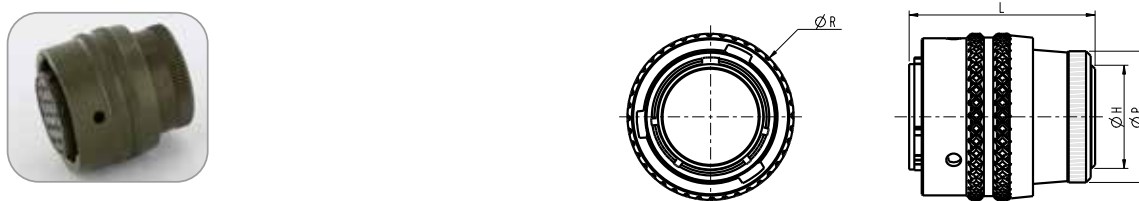

| Shell size Taille du boîtier | Ø H | L max. | Ø P | Ø R |
|---------------------------------|------|--------|------|------|
| 8 | 9.3 | 33.0 | 13.9 | 18.6 |
| 10 | 12.3 | 33.0 | 17.1 | 21.4 |
| 12 | 15.2 | 33.0 | 20.3 | 25.8 |
| 14 | 18.5 | 33.0 | 23.3 | 29.0 |
| 16 | 21.7 | 33.0 | 26.5 | 32.2 |
| 18 | 24.2 | 33.0 | 29.5 | 34.9 |
| 20 | 27.4 | 33.0 | 32.7 | 38.5 |
| 22 | 30.6 | 33.0 | 36.0 | 41.7 |
| 24 | 33.8 | 34.0 | 39.2 | 44.7 |

| | | | |
|-------------------|-------------------------|-------------------|----------|
| Solder / A souder | PT06A (SR) / PT06E (SR) | 45106AC / 45106EC | - |
| Crimp / A sertir | PT06SE (SR) | 45106RC | VG95328K |

Straight plug with cable clamp backshell.

Fiche droite avec raccord serre-câble.

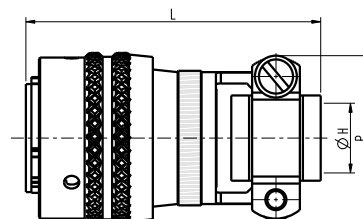
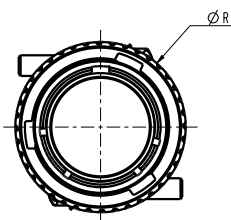

| Shell size Taille du boîtier | Ø H | L max. | P max. | Ø R |
|---------------------------------|------|--------|--------|------|
| 8 | 3.2 | 49.0 | 19.3 | 18.6 |
| 10 | 4.8 | 49.0 | 20.8 | 21.4 |
| 12 | 7.9 | 49.0 | 24.0 | 25.8 |
| 14 | 9.5 | 49.0 | 27.2 | 29.0 |
| 16 | 12.7 | 52.4 | 28.8 | 32.2 |
| 18 | 15.9 | 52.4 | 35.1 | 34.9 |
| 20 | 15.9 | 54.8 | 35.1 | 38.5 |
| 22 | 19.1 | 54.8 | 39.9 | 41.7 |
| 24 | 20.3 | 56.4 | 42.3 | 44.7 |

Note: for the version without grommet A + SR (PT) or AC (451), use the nylon ring delivered with the cable clamp to screw your backshell at the rear of the plug.

Pour la version sans serre-fil A + SR (PT) ou AC (451), utiliser la bague en nylon livrée avec le serre-câble pour visser votre raccord à l'arrière de la fiche.

| | | |
|-------------------|-------|--------|
| Solder / A souder | PT06W | 45106J |
| Crimp / A sertir | - | - |

Straight plug with metal sealing gland backshell.

Fiche droite avec raccord presse-étoupe métallique.

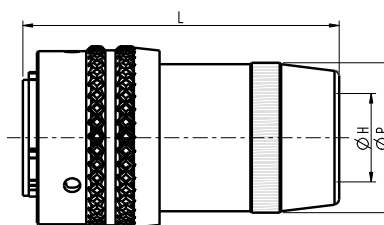
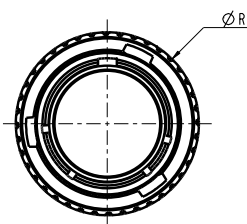

| Shell size Taille du boîtier | Ø H | | L max. | Ø P max. | Ø R |
|---------------------------------|------|------|--------|----------|------|
| | min. | max. | | | |
| 8 | 4.3 | 5.8 | 43.3 | 13.6 | 18.6 |
| 10 | 5.2 | 7.9 | 43.3 | 16.8 | 21.4 |
| 12 | 8.6 | 11.2 | 46.9 | 20.3 | 25.8 |
| 14 | 10.6 | 13.7 | 51.8 | 23.6 | 29.0 |
| 16 | 14.0 | 15.6 | 57.3 | 26.8 | 32.2 |
| 18 | 15.2 | 17.1 | 63.1 | 30.0 | 34.9 |
| 20 | 16.1 | 19.0 | 72.2 | 33.3 | 38.5 |
| 22 | 17.0 | 21.5 | 76.2 | 36.5 | 41.7 |
| 24 | 18.8 | 22.7 | 81.5 | 39.7 | 44.7 |

| | | |
|-------------------|-------------|-------------|
| Solder / A souder | PT06A (PG) | 45106A (PG) |
| Crimp / A sertir | PT06SE (PG) | 45106R (PG) |

Straight plug with adaptor terminated by a PG type plastic sealing gland.

Fiche droite avec raccord intermédiaire raccordé à un presse étoupe plastique type PG.

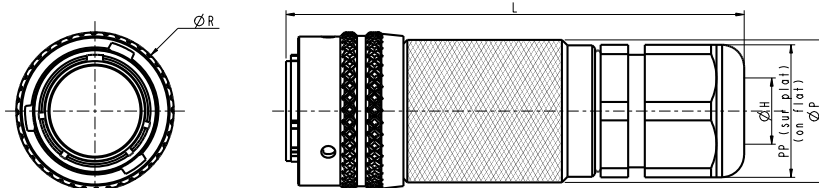

| Shell size <i>Taille du boîtier</i> | Ø H | | L max. | Ø P max. | PG size | PP | Ø R |
|--|-----|-----|--------|----------|---------|----|------|
| | min | max | | | | | |
| 8 | 2.5 | 6.5 | 76 | 16.6 | PG 7 | 15 | 18.6 |
| 10 | 3.5 | 8 | 80 | 19.5 | PG 9 | 19 | 21.4 |
| 12 | 4 | 10 | 82 | 22.8 | PG 11 | 22 | 25.8 |
| 14 | 5 | 12 | 89 | 25.8 | PG 13.5 | 24 | 29.0 |
| 16 | 9 | 14 | 91 | 28.9 | PG 16 | 27 | 32.2 |
| 18 | 9 | 14 | 96 | 32.0 | PG 16 | 27 | 34.9 |
| 20 | 9 | 14 | 99 | 35.2 | PG 16 | 27 | 38.5 |
| 22 | 13 | 18 | 108 | 38.3 | PG 21 | 33 | 41.7 |
| 24 | 13 | 18 | 110 | 41.6 | PG 21 | 33 | 44.7 |

| | | | |
|-------------------|------------|---------|----------|
| Solder / A souder | PT06E (J) | 45106T | - |
| Crimp / A sertir | PT06SE (J) | 45106RT | VG95328J |

Straight plug with backnut for heatshrink moulded piece.

Fiche droite avec raccord pour pièce moulée thermorétractable.

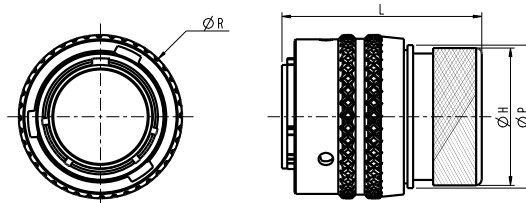

| Shell size <i>Taille du boîtier</i> | Ø H | L max. | Ø P max. | Ø R |
|--|------|--------|----------|------|
| 8 | 15.6 | 35.0 | 15.4 | 18.6 |
| 10 | 18.4 | 35.0 | 18.6 | 21.4 |
| 12 | 23.7 | 35.0 | 21.8 | 25.8 |
| 14 | 24.5 | 35.0 | 25.0 | 29.0 |
| 16 | 29.8 | 37.5 | 28.2 | 32.2 |
| 18 | 32.0 | 37.5 | 31.3 | 34.9 |
| 20 | 36.1 | 47.5 | 34.5 | 38.5 |
| 22 | 38.5 | 47.5 | 37.7 | 41.7 |
| 24 | 41.5 | 47.5 | 40.9 | 44.7 |

| | | |
|-------------------|--------|---------|
| Solder / A souder | PT06P | 45106P |
| Crimp / A sertir | PT06SP | 45106RP |

Straight plug with backshell for potting.

Fiche droite avec raccord pour potting.

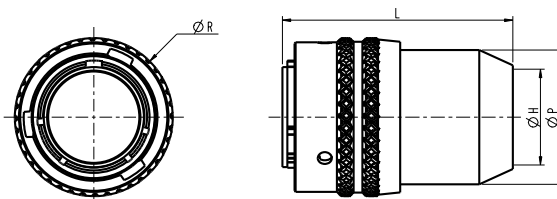

| Shell size Taille du boîtier | Ø H | L max. | | Ø P | Ø R |
|---------------------------------|------|--------|-------|------|------|
| | | Solder | Crimp | | |
| 8 | 8.3 | 35 | 44 | 14.9 | 18.6 |
| 10 | 11.3 | 35 | 44 | 18.1 | 21.4 |
| 12 | 14.2 | 35 | 44 | 21.3 | 25.8 |
| 14 | 17.3 | 35 | 44 | 24.5 | 29.0 |
| 16 | 20.5 | 35 | 44 | 27.7 | 32.2 |
| 18 | 23.1 | 35 | 44 | 30.8 | 34.9 |
| 20 | 26.3 | 39 | 48 | 34.0 | 38.5 |
| 22 | 29.4 | 39 | 48 | 37.2 | 41.7 |
| 24 | 32.6 | 40 | 49 | 40.3 | 44.7 |

| | | |
|-------------------|-----------------|-------------------|
| Solder / A souder | PT06EK / PT06KM | 45106EK / 45106KM |
| Crimp / A sertir | PT06SK | 45106SK |

Straight plug with rain proof or immersion proof sealing gland backshell.

Fiche droite avec raccord presse-étoupe étanche au ruissellement ou à l'immersion.

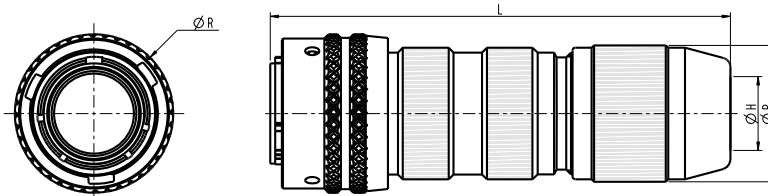

| Shell size Taille du boîtier | L max. | | Ø P | Ø R |
|---------------------------------|---------|--------------|------|------|
| | EK type | KM / SK type | | |
| 8 | 71.5 | 81.5 | 17.0 | 18.6 |
| 10 | 71.5 | 81.5 | 19.0 | 21.4 |
| 12 | 71.5 | 81.5 | 25.0 | 25.8 |
| 14 | 79.5 | 94.5 | 27.0 | 29.0 |
| 16 | 79.5 | 94.5 | 28.5 | 32.2 |
| 18 | 79.5 | 94.5 | 31.5 | 34.9 |
| 20 | 91.5 | 105.0 | 34.5 | 38.5 |
| 22 | 94.0 | 107.5 | 34.5 | 41.7 |
| 24 | 94.5 | 108.0 | 36.0 | 44.7 |

| Shell size Taille du boîtier | Ø H Acceptable cable diameter / Diamètre de câble admissible | | |
|---------------------------------|---|--------------------------|--------------------------|
| | Gasket n° 1 / Joint n° 1 | Gasket n° 2 / Joint n° 2 | Gasket n° 3 / Joint n° 3 |
| | 8 | 4.0 to 5.0 | 5.0 to 6.5 |
| 10 | 5.0 to 6.5 | 6.5 to 8.0 | |
| 12 | 8.0 to 9.5 | 9.5 to 11.0 | |
| 14 | 10.5 to 12.0 | 12.0 to 13.5 | 7.0 to 9.5 |
| 16 | 12.5 to 14.0 | 14.0 to 15.6 | |
| 18 | 15.0 to 17.0 | 17.0 to 19.0 | 14 to 15.6 |
| 20 | 15.0 to 17.0 | 17.0 to 19.0 | 14 to 15.6 |
| 22 | 17.0 to 19.0 | 19.0 to 21.5 | |
| 24 | 18.5 to 20.5 | 20.5 to 23.0 | |

all dimensions are in mm

Plug with grounding ring G06 / 36 types Fiche avec bague de blindage types G06 / 36

| | | | |
|-------------------|--------------|---------|----------|
| Solder / A souder | PTG06E (SQ) | 45136G | - |
| Crimp / A sertir | PTG06SE (SQ) | 45136RG | VG95328M |

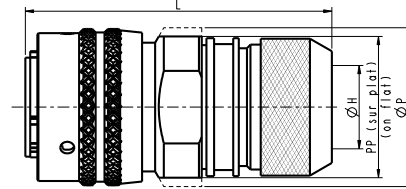
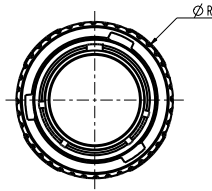

Straight plug with SQ braid clamping backshell.
Fiche droite avec raccord SQ pour reprise de tresse.

| Shell size <i>Taille du boîtier</i> | Ø H min. | L max. | Ø P | PP | Ø R |
|--|----------|--------|-----|------|------|
| 8 | 6.7 | 54 | 20 | 16.8 | 18.6 |
| 10 | 9.2 | 54 | 24 | 20.8 | 21.4 |
| 12 | 12.2 | 55 | 26 | 22.8 | 25.8 |
| 14 | 15.2 | 55 | 29 | 25.8 | 29.0 |
| 16 | 18.3 | 55 | 32 | 28.8 | 32.2 |
| 18 | 20.0 | 55 | 35 | 31.8 | 34.9 |
| 20 | 23.0 | 58 | 38 | 35.8 | 38.5 |
| 22 | 26.0 | 58 | 42 | 38.8 | 41.7 |
| 24 | 28.8 | 60 | 45 | 41.8 | 44.7 |

SQ backshell (in accordance with VG95328 standard):

- Compatible with **solder and crimp** contact versions and with 00, 01, 07 & G06 shell types.
- High EMI-RFI protection level.
- Clamping braid backshell by screwing system.
- Sealed when equipped with straight or right angled heatshrink moulded pieces mentioned on page 61.
- User friendly, no tooling required.

Please consult us for cabling information.

Raccord SQ (conforme à la norme VG95328) :

- Compatible avec les versions à souder et à sertir, et avec les types de boîtier 00, 01, 07 et G06.
- Excellent niveau de protection EMI.
- Raccord à reprise de tresse par un système de vissage.
- Étanche lorsqu'il est équipé d'une pièce moulée thermorétractable droite ou coudée, telle que mentionnée page 61.
- Facile à utiliser, aucun outil n'est nécessaire.

Veuillez nous consulter pour de plus amples renseignements sur le câblage.

PT06G / PT08G backshells = Amphenol Socapex design
Raccords PT06G / PT08G = conception Amphenol Socapex

| | | |
|-------------------|-------|---|
| Solder / A souder | PT06G | - |
| Crimp / A sertir | - | - |



Plug with straight soldering braid backshell.

Fiche avec raccord pour reprise de tresse avec terminaison étamée droite.

| | | |
|-------------------|-------|---|
| Solder / A souder | PT08G | - |
| Crimp / A sertir | - | - |



Plug with right angled soldering braid backshell.

Fiche avec raccord pour reprise de tresse avec terminaison étamée coudée.

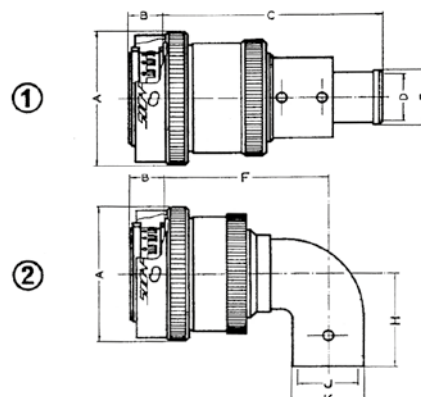

| Shell size <i>Taille du boîtier</i> | Straight Plug PT06G / <i>Fiche droite PT06G</i> | | | | | Right Angle Plug PT08G / <i>Fiche coudée PT08G</i> | | | | | |
|--|---|------|--------|------|------|--|------|--------|------|------|-----|
| | Ø A | B | C max. | Ø D* | E | Ø A | B | F max. | H | Ø J* | Ø K |
| 8 | 18.6 | 9 | 37.2 | 9 | 12 | - | - | - | - | - | - |
| 10 | 21.4 | 9 | 42.0 | 6 | 7.5 | 21.4 | 9 | 36 | 17 | 10 | 12 |
| 12 | 25.8 | 9 | 44.8 | 12.4 | 13.8 | 25.8 | 9 | 33.5 | 17 | 10 | 12 |
| 14 | 29.0 | 9 | 44.8 | 14 | 15.8 | 29.0 | 9 | 35 | 19.5 | 12 | 14 |
| 16 | 32.2 | 9 | 48.5 | 15 | 17.5 | 32.2 | 9 | 37.5 | 22 | 14 | 16 |
| 18 | 34.9 | 9 | 54.5 | 12.4 | 13.8 | 34.9 | 9 | 41.5 | 24 | 16 | 18 |
| 20 | 38.5 | 10.5 | 63.0 | 17 | 20 | 38.5 | 10.5 | 47.4 | 26.5 | 18 | 20 |
| 22 | 41.7 | 10.5 | 63.0 | 19 | 22 | 41.7 | 10.5 | 48.9 | 32 | 20 | 22 |

* D and J: diameter of the cable unjacketed and without braid.
 Please consult us for cabling information.

** D et J : diamètre du câble sans gaine et sans tresse.*

Veillez nous consulter pour de plus amples renseignements sur le câblage.

- Compatible with **solder contact** version and with 06 & 08 shell types.
- Outstanding EMI-RFI protection level.
- Soldering braid backshell (the rear soldering part of the backshell is tin plated to allow soldering of the braid).
- Available in straight or right angle version (low profile).
- Sealed when equipped with heatshrink sleeve mentioned on page 61.

- Compatible avec des **contacts à souder**, et avec les types de boîtier 06 et 08.
- Excellent niveau de protection EMI.
- La partie arrière du raccord est étamée pour permettre la soudure de la tresse.
- Existe en version droite ou coudée (faible encombrement).
- Étanche lorsqu'il est équipé d'une pièce moulée thermorétractable telle que mentionnée page 61.

Right angle plug 08 type

Fiche coudée type 08

| | | |
|-------------------|-------------|---------|
| Solder / A souder | PT08E (SR) | 45108EC |
| Crimp / A sertir | PT08SE (SR) | 45108RC |

Plug with 90° cable clamp backshell.

Fiche avec raccord serre-câble coudé à 90°.

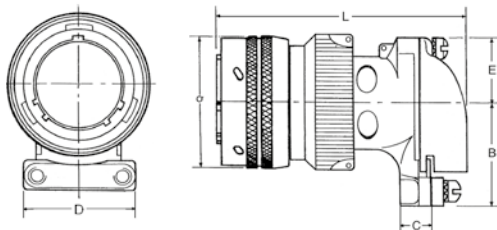

| Shell size <i>Taille du boîtier</i> | B | C | | D ±1.6 | E | L max. | Q |
|--|------|------|------|-----------|------|--------|------|
| | | min | max | | | | |
| 8 | 16.6 | 4.3 | 6.6 | 23.9 | 8.6 | 53 | 18.6 |
| 10 | 19.0 | 4.3 | 9.8 | 30.2 | 10.0 | 55 | 21.4 |
| 12 | 20.6 | 6.7 | 9.6 | 30.2 | 11.4 | 58 | 25.8 |
| 14 | 23.0 | 7.8 | 13.8 | 31.8 | 13.2 | 61 | 29.0 |
| 16 | 26.2 | 8.4 | 16.2 | 33.4 | 14.8 | 65 | 32.2 |
| 18 | 25.8 | 11.2 | 17.4 | 39.7 | 15.8 | 69 | 34.9 |
| 20 | 27.4 | 12.9 | 19.6 | 41.3 | 17.3 | 71 | 38.5 |
| 22 | 28.9 | 13.0 | 21.8 | 43.6 | 18.8 | 72 | 41.7 |
| 24 | 32.1 | 16.7 | 23.4 | 44.5 | 20.2 | 78 | 44.7 |

| | | |
|-------------------|-------|--------|
| Solder / A souder | PT08P | 45108P |
| Crimp / A sertir | - | - |

Plug with 75° angled backshell for potting.

Fiche avec raccord pour potting coudé à 75°.

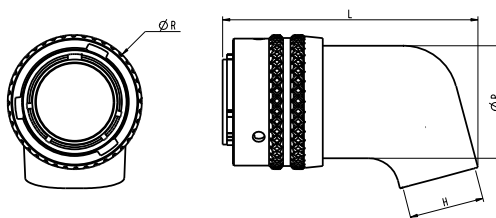

| Shell size <i>Taille du boîtier</i> | H | L max. | Ø P max. | Ø R |
|--|-------------|--------|----------|------|
| 8 | 7.9 x 11.1 | 42.5 | 14.8 | 18.6 |
| 10 | 11.1 x 14.3 | 46.0 | 18.0 | 21.4 |
| 12 | 13.1 x 17.5 | 48.5 | 21.2 | 25.8 |
| 14 | 15.9 x 19.8 | 50.0 | 24.4 | 29.0 |
| 16 | 16.7 x 22.6 | 51.5 | 27.6 | 32.2 |
| 18 | 17.9 x 25.4 | 52.5 | 30.7 | 34.9 |
| 20 | 19.5 x 28.6 | 59.5 | 33.9 | 38.5 |
| 22 | 20.6 x 31.3 | 60.5 | 37.1 | 41.7 |
| 24 | 23.3 x 34.9 | 69.0 | 40.2 | 44.7 |

Receptacle with locking ring 09 type

Embase à écrou type 09

| | | |
|-------------------|-------|--------|
| Solder / A souder | PT09A | 45109E |
| Crimp / A sertir | - | - |

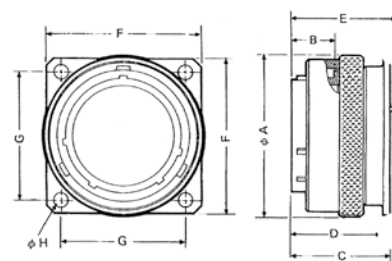

Square flange receptacle with locking ring.
Embase à collerette carrée avec écrou de verrouillage.

| Shell size Taille du boîtier | Ø A max. | B ± 0.3 | C + 0.5 0 | D ± 0.4 | E + 0.7 - 0.9 | F ± 0.3 | G ± 0.12 | Ø H ± 0.1 |
|---------------------------------|----------|------------|-----------------|------------|---------------------|------------|-------------|--------------|
| 8 | 18.6 | 9 | 21 | 19.5 | 22.4 | 20.6 | 15.09 | 3.2 |
| 10 | 21.4 | 9 | 21 | 19.5 | 22.4 | 23.8 | 18.26 | 3.2 |
| 12 | 25.8 | 9 | 21 | 19.5 | 22.4 | 26.2 | 20.62 | 3.2 |
| 14 | 29.0 | 9 | 21 | 19.5 | 22.4 | 28.6 | 23.01 | 3.2 |
| 16 | 32.2 | 9 | 21 | 19.5 | 22.4 | 31.0 | 24.61 | 3.2 |
| 18 | 34.9 | 9 | 21 | 19.5 | 22.4 | 33.3 | 26.97 | 3.2 |
| 20 | 38.5 | 10.5 | 24.9 | 22.6 | 26.2 | 36.5 | 29.36 | 3.2 |
| 22 | 41.7 | 10.5 | 24.9 | 22.6 | 26.2 | 39.7 | 31.75 | 3.2 |
| 24 | 44.7 | 10.5 | 26.5 | 24.1 | 26.2 | 42.9 | 34.93 | 3.7 |

Receptacles with PCB and wire wrap contacts

Embases avec contacts à piquer et à wrapper

| | | |
|-------------|--------|---------|
| YS contacts | PT02YS | 45102YS |
| Y contacts | PT02Y | 45102Y |
| GS contacts | PT02GS | 45102GS |

Square flange receptacle / PCB contacts.
Embase à collerette carrée / Contacts à piquer.

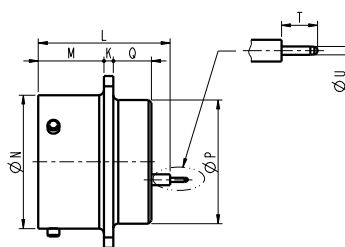

| | | |
|-------------|--------|---------|
| YS contacts | PT07YS | 45107YS |
| Y contacts | PT07Y | 45107Y |
| GS contacts | PT07GS | 45107GS |

Jam nut receptacle / PCB contacts.
Embase à fixation par écrou / Contacts à piquer.

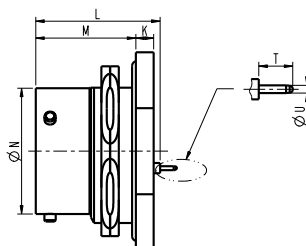

To mount the receptacle on the panel, please refer to page 63 for panel drilling and thickness.
Please have a look at page 63 for PCB drilling dimensions.

Pour le montage des embases sur panneau, se référer à la page 63 pour le perçage et l'épaisseur des panneaux.
Reportez-vous à la page 63 pour le perçage des circuits imprimés.

all dimensions are in mm

MW contacts PT02MW 45102MW

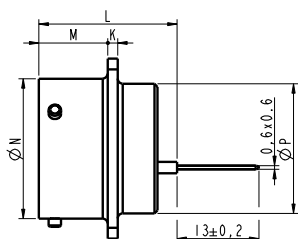

Square flange receptacle / Wire wrap contact.
Embase à collerette carrée / Contacts à wrapper.

MW contacts PT07MW 45107MW

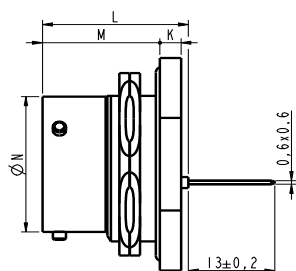

Jam nut receptacle / Wire wrap contact.
Embase à fixation par écrou / Contacts à wrapper.

| Shell size <i>Taille du boîtier</i> | K | | M | | Ø N | Ø P | Q |
|--|------|-----|-------|------|-------|------|------|
| | 02 | 07 | 02 | 07 | | | |
| 8 | 1.57 | 3.2 | 10.95 | 17.7 | 12.01 | 11.4 | 6.35 |
| 10 | 1.57 | 3.2 | 10.95 | 17.7 | 14.99 | 14.6 | 6.35 |
| 12 | 1.57 | 3.2 | 10.95 | 17.7 | 19.05 | 17.8 | 6.35 |
| 14 | 1.57 | 3.2 | 10.95 | 17.7 | 22.23 | 20.9 | 6.35 |
| 16 | 1.57 | 3.2 | 10.95 | 17.7 | 25.40 | 24.1 | 6.35 |
| 18 | 1.57 | 3.2 | 10.95 | 17.7 | 28.58 | 27.3 | 6.35 |
| 20 | 2.39 | 4.0 | 14.12 | 22.5 | 31.75 | 30.5 | 8.74 |
| 22 | 2.39 | 4.0 | 14.12 | 22.5 | 34.93 | 33.6 | 8.74 |
| 24 | 2.39 | 4.0 | 14.96 | 23.3 | 38.10 | 36.8 | 8.74 |

| Shell size <i>Taille du boîtier</i> | T(Y) +0.2 -0 | T(GS) ±0.1 | T(YS) +0.2 -0 | Ø U(Y) +0.15 -0.1 | Ø U(GS) +0.15 -0.1 | Ø U(YS) +0.15 -0.1 |
|--|--------------------|---------------|---------------------|-------------------------|--------------------------|--------------------------|
| 8 | 3 | 4.5 | 7 | 0.7 | 0.7 | 0.7 |
| 10 | 3 | 4.5 | 7 | 0.7 | 0.7 | 0.7 |
| 12 | 3 | 4.5 | 7 | 0.7 | 0.7 | 0.7 |
| 14 | 3 | 4.5 | 7 | 0.7 | 0.7 | 0.7 |
| 16 | 3 | 4.5 | 7 | 0.7 | 0.7 | 0.7 |
| 18 | 3 | 4.5 | 7 | 0.7 | 0.7 | 0.7 |
| 20 | 3 | 4.5 | 7 | 0.7 | 0.7 | 0.7 |
| 22 | 3 | 4.5 | 7 | 0.7 | 0.7 | 0.7 |
| 24 | 3 | 4.5 | 7 | 0.7 | 0.7 | 0.7 |

| Shell size <i>Taille du boîtier</i> | L(Y) ± 0.5 (pin) / ± 1.1 (socket) | L(GS) ± 0.5 (pin) / ± 1.1 (socket) | L(YS) ± 0.5 (pin) / ± 1.1 (socket) | L(MW) ± 0.6 (pin) / ± 1.2 (socket) |
|--|--------------------------------------|---------------------------------------|---------------------------------------|---------------------------------------|
| 8 | 21.96 | 23.16 | 21.96 | 22.8 |
| 10 | 21.96 | 23.16 | 21.96 | 22.8 |
| 12 | 21.96 | 23.16 | 21.96 | 22.8 |
| 14 | 21.96 | 23.16 | 21.96 | 22.8 |
| 16 | 21.96 | 23.16 | 21.96 | 22.8 |
| 18 | 21.96 | 23.16 | 21.96 | 22.8 |
| 20 | 28.73 | 29.23 | 28.73 | 29.6 |
| 22 | 28.73 | 29.23 | 28.73 | 29.6 |
| 24 | 28.73 | 29.23 | 28.73 | 29.6 |

Hermetic receptacles Embases hermétiques

Accessories / Accessoires

Hermetic receptacles are available with three different shell types: square flange receptacle, jam nut receptacle and solder mounting receptacle. They are only available with male solder contacts.

Les embases hermétiques sont disponibles dans trois types de boîtiers différents : embase à collerette carrée, embase à fixation par écrou et embase à fixation par brasage. Elles sont disponibles uniquement avec des contacts mâles à souder.

General characteristics / Caractéristiques générales

- Shells in steel with tin plating finish
 - Glass insert
 - Pin contacts in nickel alloy with tin plated solder pot termination
 - Temperature range: -55°C +125°C
 - Hermeticity: Leak $\leq 10^{-6} \text{ cm}^3 \cdot \text{s}^{-1}$ under 1 bar differential pressure
 - Vibration: exceeds MIL-E-5272 proc. II
 - Physical shock: 100 G's
 - Current rating per contact: size 20 pin: 5A / size 16 pin: 10A
 - Dielectric withstanding voltage (at sea level):
1500 Vrms, 60 cps (service rating 1)
2300 Vrms, 60 cps (service rating 2)
-
- Boîtier en acier avec traitement de surface étamé.
 - Isolant en perle de verre.
 - Contact mâle en alliage de nickel avec fût à souder étamé.
 - Gamme de température : - 55° à + 125° C.
 - Herméticité : Fuite $\leq 10^{-6} \text{ cm}^3 \cdot \text{s}^{-1}$ sous une pression différentielle de 1 bar.
 - Résistance aux vibrations : supérieure aux clauses de la norme MIL-E-5272 proc II.
 - Résistance aux chocs : 100 G
 - Intensité max admissible par contact : contact taille 20 : 5A / contact taille 16 : 10A.
 - Tension de test (au niveau de la mer) :
1500 Vrms, 60 Hz (service 1)
2300 Vrms, 60 Hz (service 2).

Overall dimensions / Dimensions

| | | |
|-------------------|-------|---|
| Solder / A souder | PT02H | - |
| Crimp / A sertir | - | - |

Square flange receptacle.
Embase à collerette carrée.

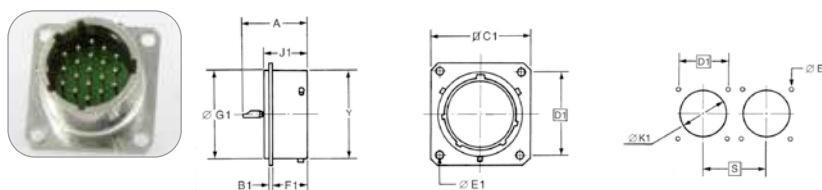

| | | |
|-------------------|-------|---|
| Solder / A souder | PT07H | - |
| Crimp / A sertir | - | - |

Jam nut receptacle.
Embase à fixation par écrou.

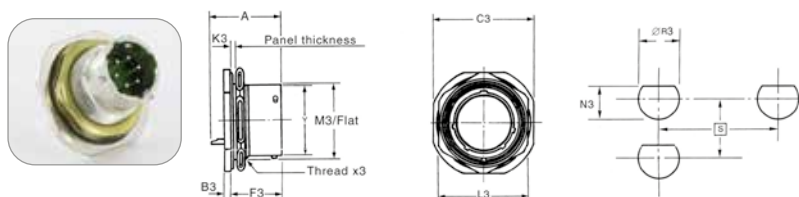

| | | |
|-------------------|------|---|
| Solder / A souder | PT1H | - |
| Crimp / A sertir | - | - |

Solder mounting receptacle.
Embase à fixation par brasage.

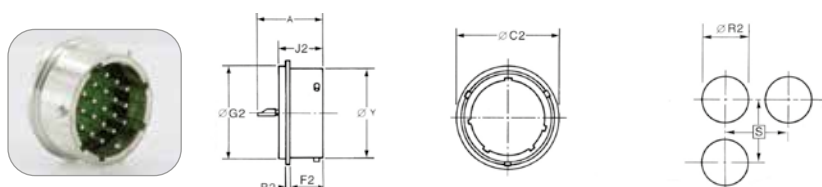

| Shell size <i>Taille du boîtier</i> | A max. | B1 ± 0.13 | B2 ± 0.13 | B3 ± 0.13 | Ø C1 ± 0.15 | Ø C2 max. | C3 max. | D1 | E1 min. | F1 ± 0.13 | F2 ± 0.13 | F3 ± 0.13 | G1 ± 0.05 | Ø G2 max. |
|--|-----------|--------------|--------------|--------------|----------------|--------------|------------|-------|---------|--------------|--------------|--------------|--------------|--------------|
| 8 | 21.03 | 1.57 | 0.91 | 2.39 | 20.62 | 16.00 | 23.93 | 15.09 | 3.05 | 11.25 | 10.82 | 17.93 | 14.22 | 14.27 |
| 10 | 21.03 | 1.57 | 0.91 | 2.39 | 23.80 | 19.18 | 27.10 | 18.26 | 3.05 | 11.25 | 10.82 | 17.93 | 17.02 | 17.07 |
| 12 | 21.03 | 1.57 | 0.91 | 2.39 | 26.19 | 21.56 | 31.88 | 20.62 | 3.05 | 11.25 | 10.82 | 17.93 | 19.79 | 19.84 |
| 14 | 21.03 | 1.57 | 0.91 | 2.39 | 28.58 | 24.74 | 35.05 | 23.01 | 3.05 | 11.25 | 10.82 | 17.93 | 22.96 | 23.01 |
| 16 | 21.03 | 1.57 | 0.91 | 2.39 | 30.94 | 27.91 | 38.23 | 24.61 | 3.05 | 11.25 | 10.82 | 17.93 | 26.14 | 26.19 |
| 18 | 21.03 | 1.57 | 0.91 | 2.39 | 33.32 | 31.06 | 41.40 | 26.97 | 3.05 | 11.25 | 10.82 | 17.93 | 29.31 | 29.36 |
| 20 | 22.61 | 2.36 | 0.91 | 3.18 | 36.50 | 33.45 | 46.15 | 29.36 | 3.05 | 14.25 | 12.40 | 22.71 | 31.70 | 31.75 |
| 22 | 22.61 | 2.36 | 0.91 | 3.18 | 39.67 | 36.65 | 49.33 | 31.75 | 3.18 | 14.25 | 12.40 | 22.71 | 34.87 | 34.93 |
| 24 | 22.61 | 2.36 | 0.91 | 3.18 | 42.85 | 39.80 | 52.50 | 34.92 | 3.18 | 15.06 | 13.23 | 23.55 | 38.05 | 38.10 |

| Shell size <i>Taille du boîtier</i> | J1 ± 0.13 | J2 ± 0.13 | K1 ± 0.13 | K3 + 1.6 - 0 | L3 + 0 - 0.25 | M3 + 0 - 0.13 | N3 ± 0.13 | Ø R2 ± 0.13 | Ø R3 ± 0.13 | S min. | Thread x3 (Class 2A) Filetage x3 (Classe 2A) | Y ± 0.8 |
|--|--------------|--------------|--------------|--------------------|---------------------|---------------------|--------------|----------------|----------------|-----------|---|------------|
| 8 | 14.91 | 14.91 | 14.43 | 1.57 | 19.05 | 13.39 | 13.72 | 14.68 | 14.53 | 31.75 | 0.5625-24 UNEF | 11.96 |
| 10 | 14.91 | 14.91 | 17.65 | 1.57 | 22.23 | 16.56 | 16.89 | 17.45 | 17.70 | 34.52 | 0.6875-24 UNEF | 14.94 |
| 12 | 14.91 | 14.91 | 21.95 | 1.57 | 26.97 | 20.70 | 21.03 | 20.24 | 22.48 | 38.89 | 0.8750-20 UNEF | 19.00 |
| 14 | 14.91 | 14.91 | 25.12 | 1.57 | 30.15 | 23.85 | 24.18 | 23.42 | 25.65 | 42.06 | 1.0000-20 UNEF | 22.17 |
| 16 | 14.91 | 14.91 | 28.27 | 1.57 | 33.32 | 27.00 | 27.33 | 26.59 | 28.83 | 45.24 | 1.1250-18 UNEF | 25.35 |
| 18 | 14.91 | 14.91 | 31.45 | 1.57 | 36.50 | 30.18 | 30.51 | 29.77 | 32.00 | 48.03 | 1.2500-18 UNEF | 28.52 |
| 20 | 17.27 | 16.48 | 34.62 | 1.57 | 39.67 | 33.35 | 33.68 | 32.16 | 35.18 | 51.59 | 1.3750-18 UNEF | 31.70 |
| 22 | 17.27 | 17.30 | 37.80 | 1.57 | 42.85 | 36.53 | 36.86 | 35.31 | 38.35 | 54.76 | 1.5000-18 UNEF | 34.87 |
| 24 | 18.08 | 18.14 | 41.02 | 1.57 | 46.02 | 39.70 | 40.03 | 38.51 | 41.53 | 57.84 | 1.6250-18 UNEF | 38.05 |

Through bulkhead receptacle type PTB

Embase traversée de cloison type PTB

| | | |
|-------------------|-----|---|
| Solder / A souder | PTB | - |
| Crimp / A sertir | - | - |

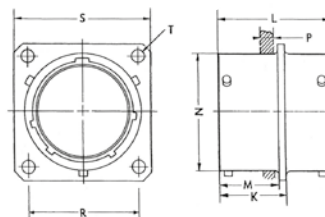

| Shell size <i>Taille du boîtier</i> | K | L | M | Ø N | P max. | R | S | T ± 0.1 |
|--|------|-------|-------|-------|--------|-------|------|------------|
| 8 | 15.9 | 26.67 | 14.27 | 12.01 | 3.2 | 15.09 | 20.6 | 3.05 |
| 10 | 15.9 | 26.67 | 14.27 | 14.99 | 3.2 | 18.26 | 23.8 | 3.05 |
| 12 | 15.9 | 26.67 | 14.27 | 19.05 | 3.2 | 20.62 | 26.2 | 3.05 |
| 14 | 15.9 | 26.67 | 14.27 | 22.23 | 3.2 | 23.01 | 28.6 | 3.05 |
| 16 | 15.9 | 26.67 | 14.27 | 25.40 | 3.2 | 24.61 | 31.0 | 3.05 |
| 18 | 15.9 | 26.67 | 14.27 | 28.58 | 3.2 | 26.97 | 33.3 | 3.05 |
| 20 | 19.8 | 33.78 | 17.48 | 31.75 | 3.2 | 29.36 | 36.5 | 3.05 |
| 22 | 19.8 | 33.78 | 17.48 | 34.93 | 3.2 | 31.75 | 39.7 | 3.05 |
| 24 | 19.8 | 33.78 | 17.48 | 38.10 | 3.2 | 34.93 | 42.9 | 3.73 |

Connectors without backshell 33 / 44 / 55 types

Connecteurs sans raccord arrière types 33 / 44 / 55

| | | |
|-------------------|--------|---|
| Solder / A souder | PT33A | - |
| Crimp / A sertir | PT33SE | - |

Square flange receptacle (00 type) without backshell.
Embase à collerette carrée (type 00) sans raccord arrière.

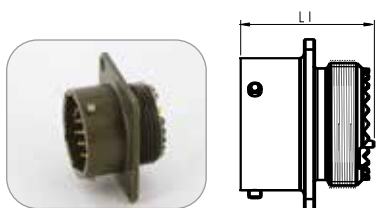

Solder / A souder

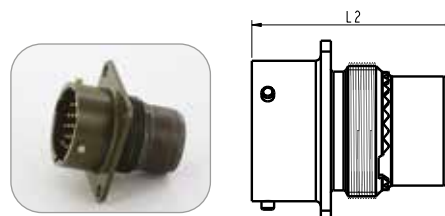

Crimp / A sertir

| | | |
|-------------------|--------|---|
| Solder / A souder | PT44A | - |
| Crimp / A sertir | PT44SE | - |

Inline receptacle (01 type) without backshell.
Prolongateur (type 01) sans raccord arrière.

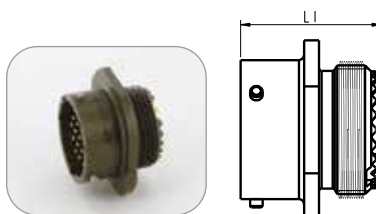

Solder / A souder

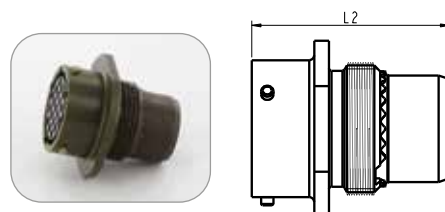

Crimp / A sertir

| | | |
|-------------------|------------------|---|
| Solder / A souder | PT55A / PTG55A | - |
| Crimp / A sertir | PT55SE / PTG55SE | - |

Plug (06 type) without backshell. PTG version with grounding ring.
Fiche (type 06) sans raccord arrière. Version PTG avec bague de masse.

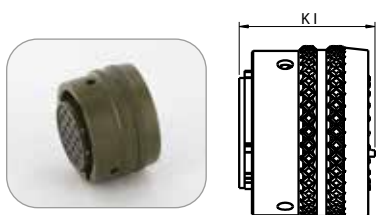

Solder / A souder

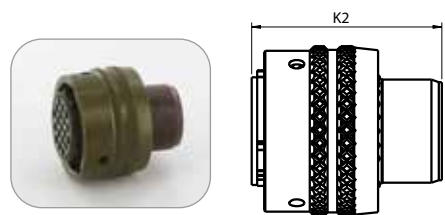

Crimp / A sertir

| Shell size Taille du boîtier | K1 max. | K2 max. | L1 max. | L2 max. | Rear thread (class 2A) Filetage arrière (classe 2A) |
|---------------------------------|---------|---------|---------|---------|--|
| 8 | 22.3 | 32.3 | 22.7 | 32.4 | 0.4375-28 UNEF |
| 10 | 22.3 | 32.3 | 22.7 | 32.4 | 0.5625-24 UNEF |
| 12 | 22.3 | 32.3 | 22.7 | 32.4 | 0.6875-24 UNEF |
| 14 | 22.3 | 32.3 | 22.7 | 32.4 | 0.8125-20 UNEF |
| 16 | 22.3 | 32.3 | 22.7 | 32.4 | 0.9375-20 UNEF |
| 18 | 22.3 | 32.3 | 22.7 | 32.4 | 1.0625-18 UNEF |
| 20 | 26.3 | 32.3 | 28.3 | 33.9 | 1.1875-18 UNEF |
| 22 | 26.3 | 32.3 | 28.3 | 33.9 | 1.3125-18 UNEF |
| 24 | 26.3 | 34.0 | 28.3 | 35.4 | 1.4375-18 UNEF |

How to order / *Comment commander*

| PT series | PT | G | 55 | A | 16 | 8 | P | - | - |
|--|-----------|----------|-----------|----------|-----------|----------|----------|----------|----------|
| G: With grounding ring (for 55 plug shell only) Omit for other versions without grounding ring | | | | | | | | | |
| Shell type: 33: 00 type / Square flange receptacle style with serrations 44: 01 type / Inline receptacle style with serrations 55: 06 type / Plug shell with serrations | | | | | | | | | |
| Contact type: A: Solder version SE: Crimp version | | | | | | | | | |
| Connector shell size: 8/10/12/14/16/18/20/22/24 | | | | | | | | | |
| Contact insert arrangement: (See page 10 & 11) | | | | | | | | | |
| Contact type: P: Pin S: Socket | | | | | | | | | |
| Coding / Insert alternate positioning: Blank for normal or W, X, Y, Z (see coding system page 9). | | | | | | | | | |
| Shell finish: Omit for standard olive drab cadmium. 01: Bright cadmium 02: Black anodised - RoHS compliant 023: Electroless nickel - RoHS compliant | | | | | | | | | |

| Série PT | PT | G | 55 | A | 16 | 8 | P | - | - |
|---|-----------|----------|-----------|----------|-----------|----------|----------|----------|----------|
| G : Avec bague de masse (pour fiche 55 uniquement) Néant pour les autres versions sans bague de masse | | | | | | | | | |
| Type de boîtier : 33 : Type 00 / Embase à collerette carrée avec arrière cranté 44 : Type 01 / Prolongateur avec arrière cranté 55 : Type 06 / Fiche avec arrière cranté | | | | | | | | | |
| Type de contact : A : Version à souder SE : Version à sertir | | | | | | | | | |
| Taille de boîtier : 8/10/12/14/16/18/20/22/24 | | | | | | | | | |
| Arrangement de contact : (voir page 10 et 11) | | | | | | | | | |
| Type de contact : P : Mâle S : Femelle | | | | | | | | | |
| Système de codage / Orientation de l'isolant : Néant pour normal ou W, X, Y, Z (voir le système de codage page 9). | | | | | | | | | |
| Traitement du boîtier : Néant pour le cadmié vert olive. 01 : Cadmié blanc 02 : Oxydation anodique noire - conforme RoHS 023 : Nickel chimique - conforme RoHS | | | | | | | | | |

Custom design *Conception spécifique*

Our PT/451 series is a perfect base for custom design in order to suit your specific needs for harsh environment applications.

Receptacle and plug shells are machined so we can easily modify outside shapes and dimensions per your requirements without any investment. We can also customize contacts thanks to our in-house screw-machining workshop.

Do not hesitate to contact us if you're looking for an innovative solution based on the rugged and reliable PT-451 product range.

Notre PT/451 est une plateforme idéale pour la réalisation de produits adaptés aux besoins spécifiques des différentes applications en environnement sévère.

Les carrosseries usinées pour tous les types d'embases et de fiches permettent de modifier les formes et dimensions extérieures sans le moindre investissement. Les contacts, décollétés dans nos ateliers, sont également modifiables très facilement.

N'hésitez donc pas à nous consulter pour que nous vous proposons des solutions innovantes sur la base de cette série robuste et fiable.

Cordsets / *Cordons*

We provide a wide range of standard, overmolded and specific cordsets / *Nous proposons une large gamme de cordons standards, surmoulés et spécifiques.*

- Standard (with heatshrink molded piece)/
Standard (avec utilisation de manchon thermo rétractable)



- Overmolding / *Surmoulage*



- Specific / *Spécifique*



Custom design *Conception spécifique*

Shells modification / *Modification des carrosseries*

Some examples / *Quelques exemples*

Stand off receptacle (to avoid any stress on pcb contacts)

Embase stand off (pour éviter toutes contraintes sur les contacts pcb)



Special receptacle for space saving

Embase spéciale pour gain de place

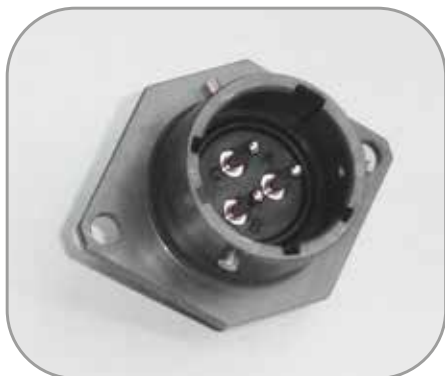

Square flange receptacle with integrated backshell (also available for plug side)

Embase à collerette carrée avec raccord intégré (disponible également du côté fiche)



Please consult us for other materials : bronze, stainless steel...

Nous consulter pour l'utilisation d'autres matériaux : bronze, acier inox...



Custom design *Conception spécifique*

Contacts modification / *Modification des contacts*

Some examples / *Quelques exemples*

Specific PCB contacts (length, flange...)
*Contacts à piquer spécifiques
(longueur, épaulement...)*



Tinned PCB contacts (RoHS option available)
Contacts à piquer étamés (option RoHS disponible)



PCB receptacle with ferrites (for filtering)
Embase à picots allongés avec ferrites (pour filtre)



Crimp contacts mounted in a single piece neoprene insert (without retention clips)
Contacts à sertir montés dans un isolant néoprène monobloc (sans clips de rétention)



Power insert arrangement 3 x 60A
Arrangement puissance 3 x 60A



Custom design Conception spécifique

Backshells & Frontshells / *Raccords arrières & bouchons*

PTSA backshell / *Raccord arrière PTSA*

- Compatible with the **crimp and solder** versions and with 33, 44 & G55 shell types.
 - High EMI-RFI protection level.
 - Clamping braid backshell by screwing system with free inner ring **to avoid twisting of the braid during screwing.**
 - Sealed when equipped with straight or right angled heatshrink moulded piece mentioned on page 57.
 - User friendly, no tooling required
- *Compatible avec les versions à sertir et à souder et avec les types de boîtiers 33, 44 et G55.*
 - *Excellent niveau de protection EMI.*
 - *Raccord à reprise de tresse par un système de vissage avec une bague intérieure indépendante qui permet d'éviter la torsion de la tresse au moment du vissage.*
 - *Étanche lorsqu'il est équipé d'une pièce moulée thermorétractable droite ou coudée, telle que mentionnée page 61.*
 - *Facile à utiliser, aucun outil n'est nécessaire.*

Overall dimensions / *Dimensions*

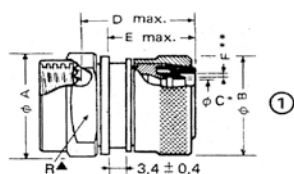

PTSA alone
PTSA seul

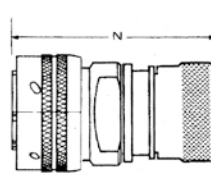

G55 shell type + PTSA
Boîtier type G55 + PTSA

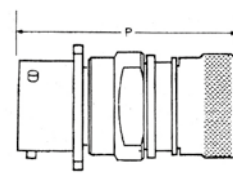

33 or 44 shell types + PTSA
Boîtier type 33 ou 44 + PTSA

| Shell size <i>Taille du boîtier</i> | A ±0.2 | B | C max.* | D | E | F max.** | N max. | P max. | R |
|--|-----------|------|---------|------|------|----------|--------|--------|------|
| 8 | 20 | 16.0 | 6.9 | 36.2 | 23 | 1 | 58 | 50.7 | 16.8 |
| 10 | 24 | 18.9 | 9.6 | 36.2 | 23 | 1 | 58 | 50.7 | 20.8 |
| 12 | 26 | 22.1 | 12.7 | 36.2 | 23 | 1 | 58 | 51.2 | 22.8 |
| 14 | 29 | 25.3 | 14.8 | 38.2 | 25 | 1 | 60 | 52.9 | 25.8 |
| 16 | 32 | 28.5 | 18.0 | 38.2 | 25 | 1.1 | 60 | 53.8 | 31.8 |
| 18 | 35 | 31.5 | 19.9 | 39.2 | 26 | 1.2 | 61 | 53.8 | 31.8 |
| 20 | 38 | 34.7 | 23.1 | 36.3 | 23.1 | 1.25 | 62 | 64 | 35.8 |
| 22 | 42 | 37.9 | 26.2 | 36.3 | 23.1 | 1.25 | 62 | 64 | 38.8 |
| 24 | 45 | 41.0 | 28.8 | 36.3 | 23.1 | 1.25 | 64 | 70.6 | 41.8 |

* : Acceptable outside diameter of the cable / *Diamètre extérieur du câble admissible*

** : Braid thickness / *Épaisseur de la tresse*

R : Dimension on flat (4 flats) / *Cote sur plat (4 plats)*

How to order / *Comment commander*

PTSA Series **PTSA** **10** **1** **-**

Backshell size corresponding to connector shell size:
8/10/12/14/16/18/20/22/24

1: Corresponding to standard braid thickness

Shell finish:

Omit for standard olive drab cadmium.

01: Bright cadmium

07: Electroless nickel - RoHS compliant

Série PTSA **PTSA** **10** **1** **-**

Taille du raccord correspondant à la taille du connecteur:
8/10/12/14/16/18/20/22/24

1: Correspondant à l'épaisseur de tresse standard

Traitement du boîtier :

Néant pour le cadmié vert olive.

01 : Cadmié blanc

07 : Nickel chimique - conforme RoHS

Custom design

Conception spécifique

PTSB Backshell - Braid clamping with metal band-it *Raccord arrière PTSB - Reprise de tresse avec band-it métallique*

- Easy implementation → Time saving
- High EMI-RFI protection level with an opening diameter adapted to the diameter of the cable
- Sealed when used with heatshrink moulded piece
- Straight or right angled versions available
- *Mise en oeuvre simple → Gain de temps*
- *Excellente protection EMI-RFI avec diamètre de sortie adapté au diamètre du câble*
- *Étanche lorsque utilisé avec une pièce moulée thermorétractable*
- *Raccord droit ou coudé*



IP67 metal sealing gland / *Presse étoupe métallique IP67*



Shortening cap / *Bouchon shunt*



Rugged RJ45 Solutions (Cat.5E and Cat.6) Solutions RJ45 renforcées (Cat.5E et Cat.6)

Presentation / *Présentation*

RJF - Ethernet connection system for harsh environment - Industrial Ethernet

RJF - Liaison Ethernet pour environnement sévère - Ethernet Industriel

RJF allows you to use an Ethernet Class D / Cat. 5E & Cat.6 connection for 10 BaseT, 100 BaseTX or 1000 BaseT networks in harsh environment.

With the patented RJStop® system you can use a standard RJ45 cordset in a metallic plug which will protect it from shocks, dust and fluids.

No hazardous on-field cabling and grounding!

Website: www.rjfield.com



Avec RJField vous réalisez une liaison Ethernet Classe D / Cat. 5E et Cat.6 pour réseaux 10 BaseT, 100 BaseTX ou 1000 BaseT en milieu sévère.

Le système breveté RJStop® permet d'utiliser un cordon RJ45 standard dans une enveloppe protectrice (fiche) le mettant à l'abri des chocs, de la poussière et des projections de liquide.

Ce système permet de s'affranchir de tout raccordement terrain, y compris des délicates reprises de blindage.

Site web : www.rjfield.com

Applications / *Applications*

- | | |
|--|---|
| ■ Robotics | ■ Robotique |
| ■ Industrial Process Control | ■ Contrôle de Process Industriel |
| ■ CNC Machines | ■ Machine Outil |
| ■ Special Machines | ■ Machines spéciales |
| ■ Oil & Gas | ■ Recherche et prospection de pétrole |
| ■ Motion Control | ■ Contrôle de motricité |
| ■ Data Acquisition and Transmission in Harsh Environment | ■ Acquisition et transmission de données en milieu sévère |
| ■ Tele-maintenance | ■ Télémaintenance |

Data transmission / *Transmission des données*

10 BaseT, 100 BaseTX and 1000 BaseT networks
Cat 5E & Cat.6 per TIA/EIA 568B and ClassD per ISO/IEC 11801

*Réseaux 10 BaseT, 100 BaseTX et 1000 BaseT
Cat 5E et Cat.6 selon TIA/EIA 568B et Classe D selon ISO/IEC 11801*

Common features Cat.5E & Cat.6 / **Caractéristiques communes Cat.5E et Cat.6**Main characteristics / *Principales caractéristiques*

- Compliant with IEC 60603-7 variant 11
- Bayonet coupling ("Audible & Visual" coupling signal)
- Robust metallic shells based on MIL-DTL-26482 H
- RJ45 cordset retention in the plug: 100 N in the axis
- Mating cycles: 500 min.
- Sealed against fluids and dust (IP68)
- Shock, Vibration and Traction resistant
- No cabling operation in field and no tools required
- Mechanical Coding / Polarization (4 positions)
- Compatible with cable diameter from 6 mm [0.236 in] to 13 mm [0.512 in]

- *Conforme à l'IEC60603-7 variante 11*
- *Verrouillage baïonnette (clic de verrouillage sensitif et auditif)*
- *Boîtiers métalliques robustes basés sur la norme MIL-DTL-26482 H*
- *Tenue du cordon RJ45 dans la fiche: 100 N dans l'axe*
- *Nombre de manoeuvres : 500 min.*
- *Étanche aux fluides et à la poussière (IP68)*
- *Résiste aux chocs, aux vibrations et tractions*
- *Aucune opération de câblage, aucun outil*
- *4 possibilités de détrompage mécanique (rotation des inserts)*
- *Compatible avec les diamètres de câbles de 6 mm à 13 mm*

Environmental characteristics / *Caractéristiques environnementales*

- | | |
|---------------------------------|---|
| ■ Sealing: | IP68 |
| ■ Salt Spray: | 48 h with Nickel plating > 96 h with Black coating > 500 h with Olive Drab Cadmium plating |
| ■ Fire Retardant/Low Smoke: | UL94 V0 and NF F 16 101 & 16 102 |
| ■ Vibrations: | 10 – 500 Hz, 10 g, 3 axes: no discontinuity > 10 nano s. |
| ■ Shocks: | IK06: weight of 250 g drop from 40 cm [15.75 in] onto connectors (mated pair) |
| ■ Humidity: | 21 days, 43°C, 98% humidity |
| ■ Thermal Shock: | 5 cycles at - 40°C / +100°C |
| ■ Temperature Range: | - 40°C / +85°C |
| ■ <i>Étanchéité :</i> | <i>IP68</i> |
| ■ <i>Brouillard salin :</i> | <i>48 h avec protection Nickelée > 96 h avec Electrophorèse noire > 500 h avec Cadmium vert olive</i> |
| ■ <i>Feu / Fumée :</i> | <i>UL94 V0 et conforme à NF F 16 101 & 16 102</i> |
| ■ <i>Vibrations :</i> | <i>10 – 500 Hz, 10 g, 3 axes : pas de micro coupure > 10 nano s.</i> |
| ■ <i>Chocs :</i> | <i>IK06: soit chute d'une de masse de 250 g de 40 cm sur connecteurs accouplés</i> |
| ■ <i>Humidité :</i> | <i>21 jours, 43°C, humidité 98%</i> |
| ■ <i>Choc thermique :</i> | <i>5 cycles - 40°C / +100°C</i> |
| ■ <i>Gamme de température :</i> | <i>- 40°C / +85°C</i> |

Overall dimensions / *Dimensions*

Assembly instructions / *Instructions d'assemblage*

Universal: Can be used with all standard RJ45 Cat 5E cordset brands.

Universel : Utilisable avec toute marque de cordon RJ45 Cat 5E standard.

1. Push down the RJ45 cordset latch, and fix it inside the insert
2. Press in and click the other part of the insert
3. Insert in the metal housing

1. Pliez la languette de la fiche RJ45 et insérez la fiche dans le logement du demi-insolant
2. Clipsez la deuxième partie de l'isolant
3. Insérez la fiche et l'isolant dans le boîtier métallique

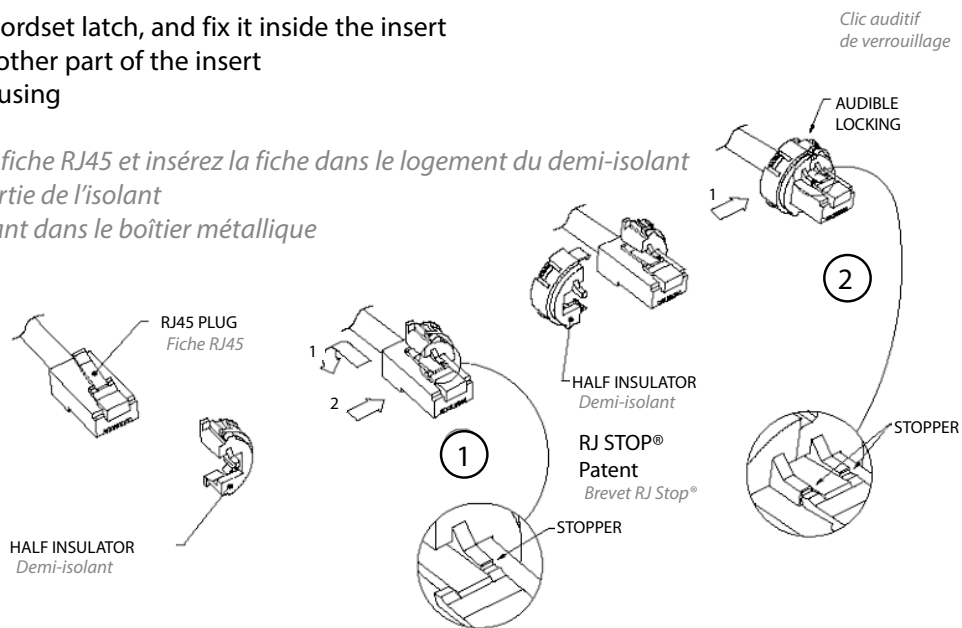

Easy and Safe: No field cabling, no tool required

Facile et sûr: Aucune opération de câblage, aucun outil

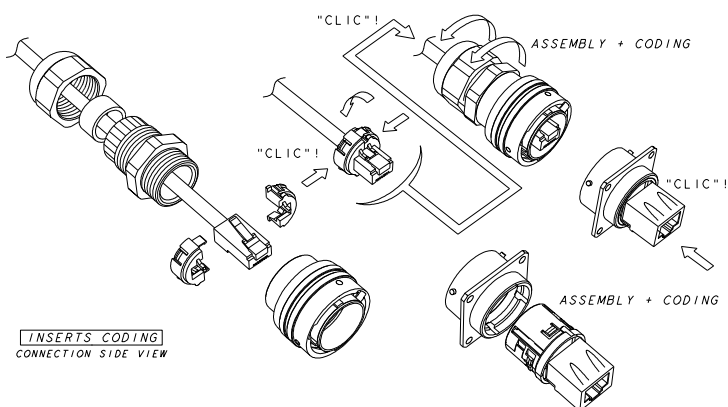

Coding system / *Système de codage*

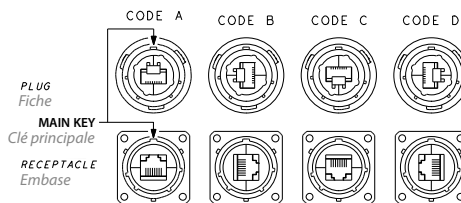

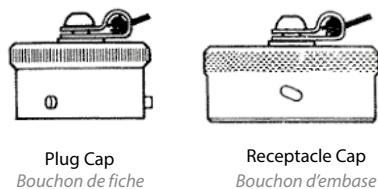
Common features Cat.5E & Cat.6 / **Caractéristiques communes Cat.5E et Cat.6**Accessories / *Accessoires*Metal cap / *Bouchon métallique*

Plug Cap

Bouchon de fiche

Receptacle Cap

Bouchon d'embase

Termination of the cord

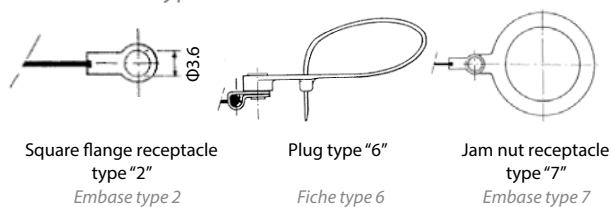
Type de fixation de la cordeletteSquare flange receptacle
type "2"*Embase type 2*

Plug type "6"

*Fiche type 6*Jam nut receptacle
type "7"*Embase type 7***RJF Caps** **RJFC** **2** **B****Connector Type:****6:** Plug**2:** Square Flange Receptacle**7:** Jam Nut Receptacle**Finish:****B:** Black Coating - RoHS compliant**N:** Nickel - RoHS compliant**G:** Olive Drab Cadmium**Bouchons RJF** **RJFC** **2** **B****Type de boîtier :****6 :** Fiche**2 :** Embase carrée**7 :** Embase à écrou**Traitement du boîtier :****B :** Electrophorèse noire - conforme RoHS**N :** Nickel - conforme RoHS**G :** Cadmié Vert OlivePanel gasket for square flange type "2" /
Joint de panneau pour embase de type "2"

- Thickness: 0,6 mm
- P/N: JE 18

- Épaisseur : 0,6 mm
- Référence : JE18

Insert removal tool for receptacle and plug /
Outils d'extraction des inserts pour embase et fiche.

- P/N: RJF ODE
- Référence : RJF ODE



Note: Only for RJF (Cat.5E) series

Remarque : Uniquement pour la série RJF (Cat.5E)

Codings - To be specified in the part number: A, B, C, or D.

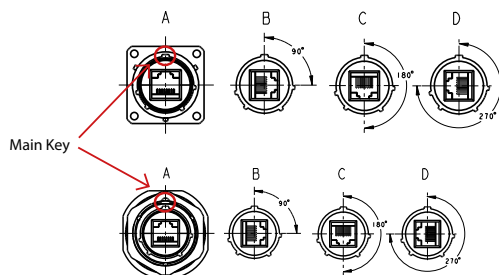

Common features Cat.5E & Cat.6 / **Caractéristiques communes Cat.5E et Cat.6**

RJF - Receptacle & plugs with 360° EMI backshells

RJF series receptacles and plugs with EMI backshells provide a solution with 360° shielding: same protection than the one proposed by standard MIL-DTL-26482H connectors. With those solutions we recommend using our reinforced and double shielded Cat5E, Cat6, or Cat6A cable

Square flange receptacle - *Straight backshell*
Embase à collerette carrée - Avec raccord

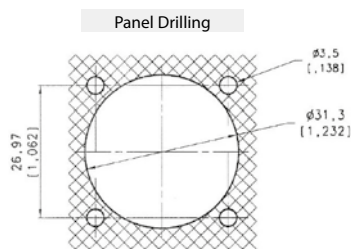
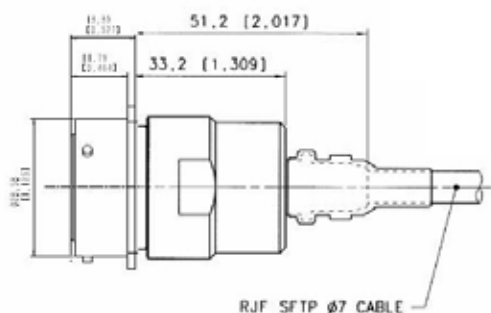

| Part number | Plating | Part number |
|-------------------------|-------------------------|-------------|
| | Nickel - ROHS compliant | Kit30439NI |
| Olive drab cadmium | Kit30439 | |
| Jam Nut receptacle | | |
| Nickel - ROHS compliant | Kit30436N | |
| Olive drab cadmium | Kit30436 | |

Kit30439 & Kit30439NI include:

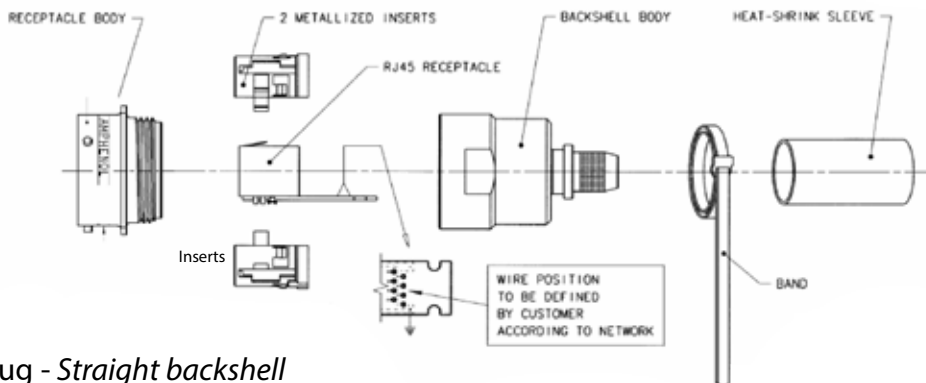

Plug - *Straight backshell*
Fiche - Avec raccord

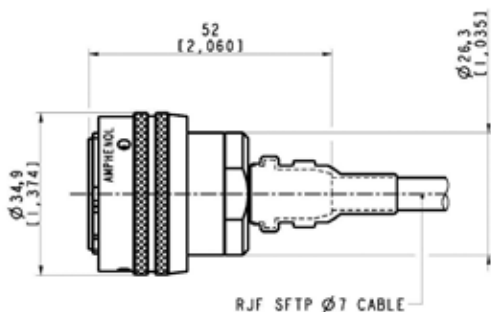

| Part number | Plating | Part number |
|--------------------|-------------------------|-------------|
| | Nickel - ROHS compliant | Kit30394NI |
| Olive drab cadmium | Kit30394 | |

Kit30394 & Kit30394NI include:



Common features Cat.5E & Cat.6 / **Caractéristiques communes Cat.5E et Cat.6**

RJ Field receptacle with Self Closing Cap / **traduction**

This kit includes a receptacle and a Self Closing Cap which protects the RJ Field square flange receptacles (MIL-C-26482 type).
 This cap offers a protection against dust and water projections.
 A spring automatically closes the upper part of the cap when either the RJfield plug, USB or IEEE1394 cordset, or USB key are removed from the receptacle.



RJF 21 X SCC

RJ45 version

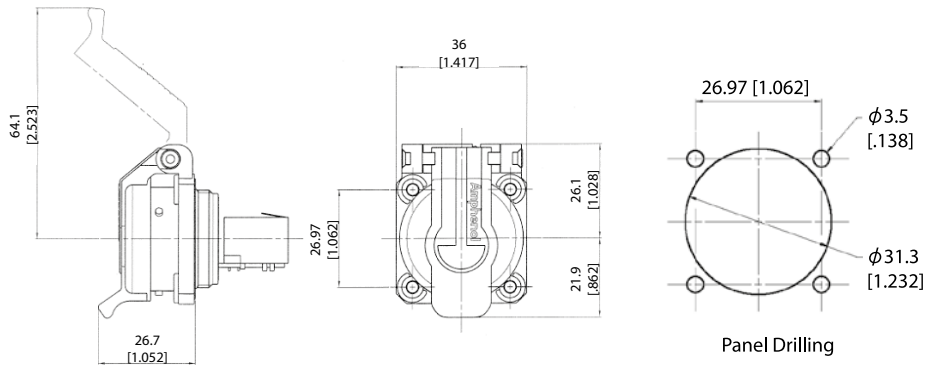

| Part number * | Plating | Metallized insert (EMI) | Part number Cat5.E | Part number Cat6 |
|---------------|--------------------------------|-------------------------|--------------------|------------------|
| | Black coating - ROHS compliant | No | RJF 21B SCC | RJF6 2 X 1 B SCC |
| | Nickel - ROHS compliant | Yes | RJF 21N SCC | RJF6 2 X 1 N SCC |
| | Olive drab cadmium | Yes | RJF 21G SCC | RJF6 2 X 1 G SCC |

* The part number includes the receptacle + the self closing cap

Remarks:

- the back termination is female RJ45
- it could be used with our RJF series plug (part number RJF6xx)

■ **Note:** Panel gasket with any of these receptacles: JE18

USB 21 x SCC, USBBF 21 x SCC & IEEE1394



USB2.0 & 3.0 - A version

USB-B version

IEEE1394 version

RJF Series (Cat.5E) / Séries RJF (Cat.5E)

How to order / Comment commander

| RJField Series (Cat5.E) | RJF | 2 | 2 | B | 03 100BTX |
|---|-----|---|---|---|-----------|
| Shell Type: 6: Plug, plastic gland 6M: Plug, metal gland 2: Square Flange Receptacle 2PE: Square Flange Receptacle, IP68 backshell, plastic gland 2PEM: Square Flange Receptacle, IP68 backshell, metal gland 7: Jam Nut Receptacle 7PE: Jam Nut Receptacle, IP68 backshell, plastic gland 7PEM: Jam Nut Receptacle, IP68 backshell, metal gland 2SA, 7SA: Transversally sealed receptacle (unmated) | | | | | |
| Back Termination (for receptacles only) : 1: Female RJ45 1RA: Right Angle Female RJ45 2: RJ45 Cordset | | | | | |
| Shell Finish: B: Black Coating - RoHS compliant N: Nickel (Note: with this version, the inserts are metallized) - RoHS compliant G: Olive Drab Cadmium (Note: with this version, the inserts are metallized) | | | | | |
| Cordset Length (for receptacles with type "2" back termination only): 03 100BTX: 0.3m [11.81 inches] 05 100BTX: 0.5m [19.68 inches] 10 100BTX: 1m [39.37 inches] 15 100BTX: 1.5m [59.05 inches] 00: 8 tinned holes at the rear of the PCB to solder the cable | | | | | |

Remark: Cabling configuration: 100 BTX = 568B (Ethernet specification)

Examples:

- Nickel plug: RJF 6 N s
- Black square flange receptacle, female RJ45 back termination: RJF 2 1 B
- Olive drab cadmium jam nut receptacle, 1.5 m [59.05"] cordset back termination: RJF 7 2 G 15 100BTX
- Black square flange receptacle, backshell with plastic gland, 30 cm [11.81"] cordset back termination: RJF 2PE 2 B 03 100BTX
- Nickel jam nut receptacle, solder termination: RJF 72 N 00

| Série RJField | RJF | 2 | 2 | B | 03 100BTX |
|--|-----|---|---|---|-----------|
| Type de boîtier : 6 : Fiche avec presse étoupe plastique 6M : Fiche avec presse étoupe métallique 2 : Embase à collerette carrée 2PE : Embase à collerette carrée et raccord presse étoupe plastique 2PEM : Embase à collerette carrée et raccord presse étoupe métallique 7 : Embase à écrou 7PE : Embase à écrou et raccord presse étoupe plastique 7PEM : Embase à écrou et raccord presse étoupe métallique 2SA, 7SA : Embase étanche en traversée (désaccouplée) | | | | | |
| Type de sortie (seulement pour les embases) : 1 : Femelle RJ45 1RA : Femelle RJ45 coudée à 90° 2 : Cordon RJ45 | | | | | |
| Protection du boîtier : B : Electrophorèse noire N : Nickel (Note: dans cette version, les inserts sont métallisés) G : Cadmié vert olive (Note: dans cette version, les inserts sont métallisés) | | | | | |
| Longueur du cordon (pour embase type 2 seulement) : 03 100BTX : 0.3m 05 100BTX : 0.5m 10 100BTX : 1m 15 100BTX : 1.5m 00 : 8 trous étamés à l'arrière du PCB pour permettre de souder un câble | | | | | |

Remarque : Configuration de câblage : 100 BTX = 568B (spécification Ethernet)

Exemples :

- Fiche nickel : RJF 6 N
- Embase carrée, noire, sortie femelle RJ45 : RJF 2 1 B
- Embase à écrou, cadmié vert, sortie cordon 1.5 m : RJF 7 2 G 15 100BTX
- Embase carrée, noire, raccord presse étoupe plastique, sortie cordon 30 cm : RJF 2PE 2 B 03 100BTX
- Embase à écrou, nickel, sortie à souder : RJF 72 N 00

RJF Series (Cat.5E) / Série RJF (Cat.5E)

Overall dimensions / Dimensions

Back Terminations / Types de sortie

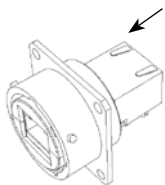

Type 1: Female RJ45
Sortie 1 : Femelle RJ45

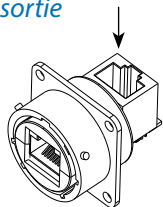

Type 1RA: Right Angle Female RJ45
Sortie 1RA : Femelle RJ45 coudée

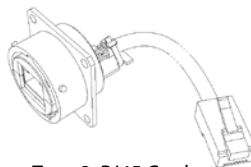

Type 2: RJ45 Cordset
Sortie 2 : Cordon RJ45

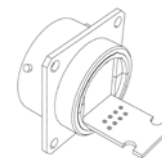

Type 2 - 00: Solder - 8 tinned holes
Sortie 2-00 : A souder - 8 trous étamés

Note: Type 2 without RJ45 plug at the end of the cable is also available: consult factory
Remarque : La sortie 2 est aussi disponible avec un câble sans fiche RJ45 à l'extrémité (nous consulter pour plus d'informations)

Plug / Fiche

Shell type 6 with Plastic or Metal Gland
Boîtier type 6 avec presse étoupe plastique ou métallique

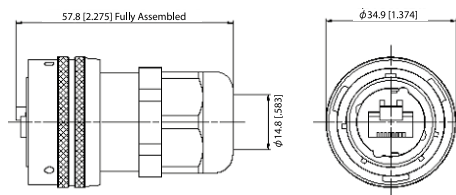

Receptacles / Embases

Square flange receptacle: Shell type 2
Embase carrée : Boîtier type 2

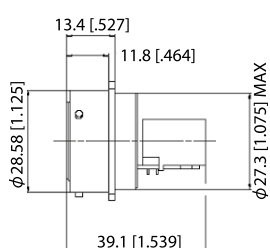

RJF 21 x
Straight Female RJ45
Sortie RJ45 droite

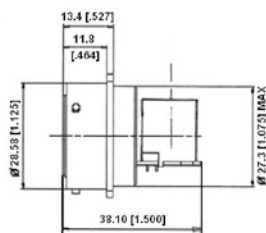

RJF 21 RA x
Right Angle Female RJ45
Sortie RJ45 coudée

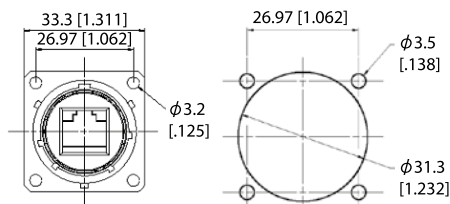

Panel Drilling
Découpe de Panneau

Jam nut receptacle: Shell type 7
Embase à écrou : Boîtier type 7

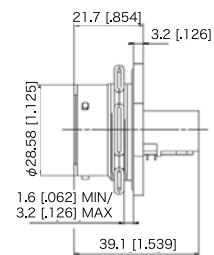

RJF 71 x
Straight Female RJ45
Sortie RJ45 droite

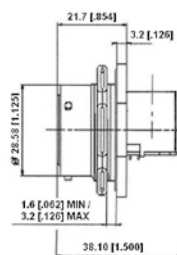

RJF 71 RA x
Right Angle Female RJ45
Sortie RJ45 coudée

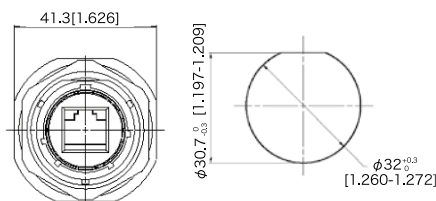

Panel Drilling
Découpe de Panneau

Receptacles with IP68 backshell: Shell types 2PE and 7PE with plastic or metal gland
Embases avec raccord IP68 : Boîtier types 2PE et 7PE avec presse étoupe plastique ou métallique

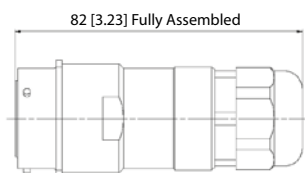

RJF 2PE / 2PEM

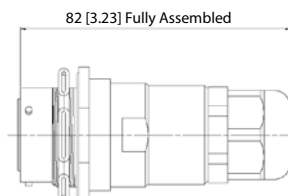

RJF 7PE / 7PEM

RJF6 Series (Cat.6) / Séries RJF6 (Cat.6)
How to order / Comment commander
Part number code: receptacles
RJField Series (Cat.6) **RJF6** **2** **A** **PE** **1** **B**
Shell type
2: square flange receptacle

7: jam nut receptacle

Nota: also available a transversally sealed receptacle (unmated)

Coding
A, B, C, or D
Backshells
PE: IP68 backshell, plastic gland

PEM: IP68 backshell, metal gland

Blank for receptacles without backshell

Back termination
1: female RJ45

Shell finishes
B: black coating - ROHS compliant

N: nickel - ROHS compliant

G: olive drab cadmium

BZC: aluminium shell - black zinc cobalt plating

ZC: aluminium shell - green zinc cobalt plating - ROHS compliant

NOTA: for N,G, BZC, and ZC plating, the inserts are metallized.

Example: square flange receptacle, coding A, female RJ45 back termination, black plating ⇒ RJF6 2 A 1 B

Part number code: plug
RJField Series (Cat.6) **RJF6** **6** **B**
Shell type
6: plug, plastic gland

6M: plug, metal gland

Shell finishes
B: black coating - ROHS compliant

N: nickel (note: with this version, the inserts are metallized) - ROHS compliant

G: olive drab cadmium (note: with this version, the inserts are metallized)

BZC: aluminium shell - black zinc cobalt plating

ZC: aluminium shell - green zinc cobalt plating - ROHS compliant

Example: plug with metal gland, nickel plating ⇒ RJF 6M N

Part number code: embase
RJField Series (Cat.6) **RJF6** **2** **A** **PE** **1** **B**
Type de boîtier:
2: Embase à collerette carrée

7: Embase à écrou

Remarque: Aussi disponible en embase étanche en traversée (désaccouplée)

Codages
A, B, C, ou D
Raccords
PE: IP68 raccord avec presse étoupe plastique

PEM: IP68 raccord avec presse étoupe métallique

Néant pour l'embase sans raccord

Fixation arrière
1: RJ45 femelle

Protection du boîtier
B: Electrosphère noire

N: Nickel

G: Cadmié vert olive

BZC: aluminium shell - black zinc cobalt plating

ZC: aluminium shell - green zinc cobalt plating - ROHS compliant

Remarque: pour le traitement N,G, BZC, et ZC, les inserts sont métallisés

Example: embase carré, codé A, RJ45 femelle fixation arrière, traitement noir ⇒ RJF6 2 A 1 B

Part number code: fiche
RJField Series (Cat.6) **RJF** **6** **B**
Type de boîtier
6: fiche avec presse étoupe plastique

6M: fiche avec presse étoupe métallique

Protection du boîtier
B: Electrosphère noire

N: Nickel (remarque: dans cette version, les inserts sont métallisés)

G: Cadmié vert olive (remarque: dans cette version, les inserts sont métallisés)

BZC: aluminium shell - black zinc cobalt plating

ZC: aluminium shell - green zinc cobalt plating - ROHS compliant

Example: fiche avec presse étoupe métallique, traitement nickel ⇒ RJF 6M N

RJF6 Series (Cat.6) / **Séries RJF6 (Cat.6)**

Overall dimensions / *Dimensions*

Plug / *Fiche*

Shell type 6 with Plastic or Metal Gland
Boîtier type 6 avec presse étoupe plastique ou métallique

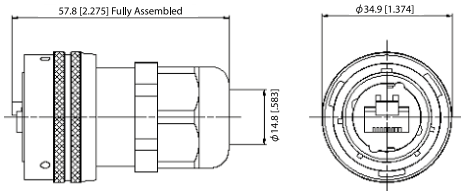

Back termination
Fixation arrière

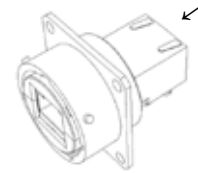

Type 1 - Female RJ45
Sortie 1 - Femelle RJ45

Receptacles / *Embases*

Square flange receptacle • 4 mounting holes: shell type 2
Embase à collerette carrée • 4 mounting holes: boîtier type 7

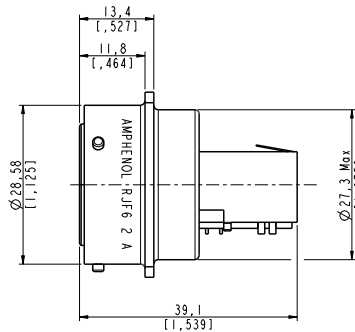

RJF6 2 X 1 X
 Straight Female RJ45
Sortie RJ45 droite

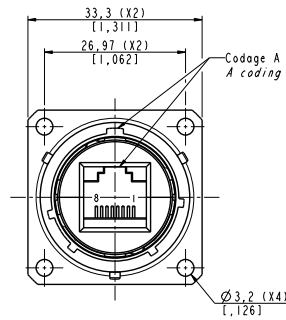

Panel Drilling
Découpe de Panneau

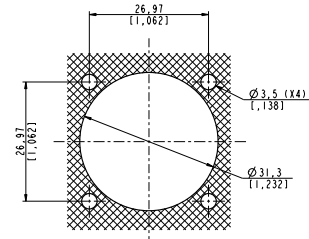

Jam nut receptacle • Hexagonal nut mounting: shell type 7
Embase à écrou • Hexagonal nut mounting: Boîtier type 7

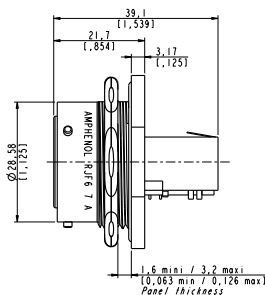

RJF6 7 x 1 X
 Straight Female RJ45
Sortie RJ45 droite

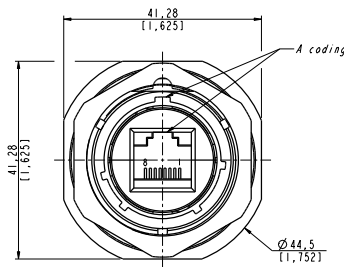

Panel Drilling
Découpe de Panneau

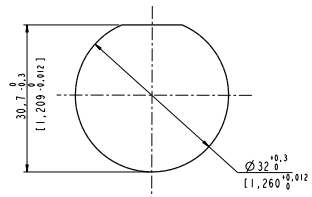

Receptacles with IP68 backshell : shell type 2PE and 7PE with plastic or metal gland
Embases avec raccord IP68 : Boîtier types 2PE et 7PE avec presse étoupe plastique ou métallique

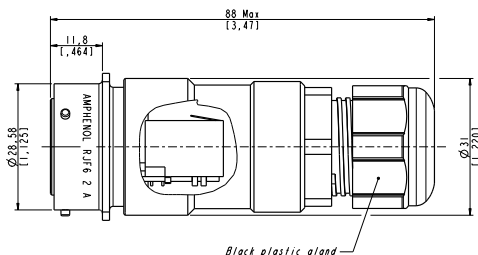

RJF6 2 X PE 1 X / 2 X PEM 1 X

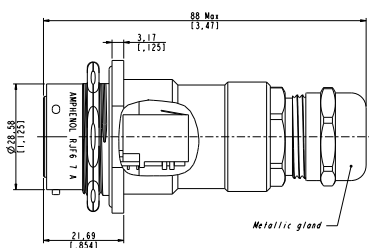

RJF6 7 X PE 1 X / 7 X PEM 1 X

NOTES

A series of horizontal dotted lines for taking notes, spanning the width of the page.



Protective caps / *Bouchons de protection*

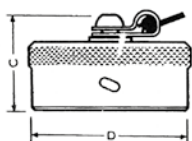

Protective cap for 00, 01, 02 and 07 shell types
Bouchons de protection pour les types de boîtiers 00, 01, 02 et 07

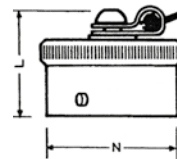

Protective cap for 06 & 08 shell types
Bouchons de protection pour les types de boîtiers 06 et 08

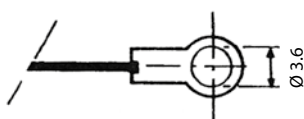

Termination of the nylon cord (or metal chain) for 00, 02 shell types protective caps.

Type de fixation de la cordelette nylon (ou chaînette métallique) pour les bouchons de protection des types de boîtiers 00, 02.

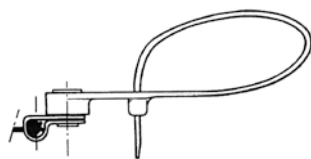

Termination of the nylon cord for 06, 08, 01 shell types protective caps (there is no termination on the metal chain).

Type de fixation de la cordelette nylon pour les bouchons de protection des types de boîtiers 06, 08, 01 (il n'y a aucune fixation sur la chaînette métallique).

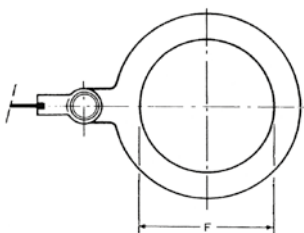

Termination of the nylon cord (or metal chain) for 07 shell type protective caps.

Type de fixation de la cordelette nylon (ou chaînette métallique) pour les bouchons de protection des types de boîtiers 07.

Length of the nylon cord (or metal chain)

From the protective cap to the cord / chain extremity:

- 160 mm long for 01, 06, 08 shell types protective caps.
- 105 mm long for 00, 02, 07 shell types protective caps.

Longueur de la cordelette nylon (ou chaînette métallique)

A partir du bouchon de protection jusqu'à l'extrémité de la cordelette / chaînette :

- 160 mm pour les bouchons de protection des types de boîtiers 01, 06 et 08.
- 105 mm pour les bouchons de protection des types de boîtiers 00, 02 et 07.

| Shell size <i>Taille du boîtier</i> | C | Ø D max. | Ø F | L max. | Ø N |
|--|----|----------|------|--------|-------|
| 8 | 20 | 17.9 | 14.7 | 18.2 | 12.01 |
| 10 | 20 | 20.7 | 17.9 | 18.2 | 14.99 |
| 12 | 20 | 25.4 | 22.6 | 18.2 | 19.05 |
| 14 | 20 | 28.7 | 25.8 | 18.2 | 22.23 |
| 16 | 20 | 31.9 | 29.0 | 18.2 | 25.40 |
| 18 | 20 | 34.7 | 32.2 | 18.2 | 28.58 |
| 20 | 20 | 38.0 | 35.3 | 19.8 | 31.75 |
| 22 | 20 | 41.2 | 38.5 | 19.8 | 34.93 |
| 24 | 21 | 44.3 | 41.7 | 20.6 | 38.10 |

PT / 451 Caps**B****ER****N**

-

08

-

Protective cap type:**F:** For plug**EC:** For square flange receptacle**ER:** For jam nut receptacle**P:** For inline receptacle**Wire type:****N:** Nylon cord (standard version)

Blank for metal chain

PT: For plugs with nylon cord only

Omit for all other versions and for metal chain

Corresponding connector shell size: 8/10/12/14/16/18/20/22/24**Finish:**

Blank for olive-drab cadmium.

07: Electroless nickel - RoHS compliant**(0)33:** Black Zinc Nickel - RoHS Compliant**Bouchons PT / 451****B****ER****N**

-

08

-

Types de bouchons de protection :**F:** Pour fiche**EC:** Pour embase carrée**ER:** Pour embase à écrou**P:** Pour prolongateur**Type de corde :****N:** Cordelette nylon (version standard)

Néant pour chaînette métallique

PT: Pour fiches avec cordelette nylon seulement

Néant pour toutes les autres versions et les chaînettes métalliques

Taille de boîtier du connecteur correspondant : 08/10/12/14/16/18/20/22/24**Traitement de surface :**

Néant pour cadmié vert olive.

07 : Nickel chimique - conforme RoHS**(0)33:** Zinc Nickel Noir - conforme RoHS

Snap caps / *Bouchons à fermeture automatique*

Problems with your connectors because the caps were never used?
What about a solution that ensures automatic sealing with each connection?

Amphenol Socapex introduces a new accessory for PT / 451 series : **the SNAP CAP!**

This Self Closing Cap mounted with a square flange receptacle protects your system against dust and water intrusion. A built in spring enables the device to automatically close on the receptacle when the plug is removed. To install just place the cap on the square flange receptacle and use your standard screws.

- Six sizes are available: 8, 10, 12, 14, 16 & 18.
- **IP54** - Protection against water spray and dust
- How to order:
Add "SCC" at the end of the part number for a square flange receptacle type 02 or 00
Ex: PT02A1210P023 **SCC** / 45102E1210P5070 **SCC**

*Combien de fois avez-vous vu un bouchon pendre à côté de son embase ?
Que pensez-vous d'une solution qui assure une étanchéité systématique sur vos embases ?*

*Amphenol Socapex introduit une nouveauté dans la gamme PT/451: **le SNAP CAP!***

Ce bouchon à fermeture automatique associé à une embase à collerette carrée protège votre système de la poussière et des projections d'eau. Sa spécificité réside dans un clapet qui se rabat automatiquement sur la partie supérieure de l'embase lorsque la fiche est déconnectée. Pour l'installer, placer le bouchon sur l'embase et utiliser vos vis habituelles.

- *Six tailles sont aujourd'hui disponibles pour ce bouchon : 8, 10, 12, 14, 16 et 18*
- **IP54** - Protection contre les projections d'eau et poussières
- *Comment commander :*
Ajouter " SCC " à la fin de votre référence PT ou 451 d'embase carrée type 02 ou 00
*Ex: PT02A1210P023 **SCC** / 45102E1210P5070 **SCC***



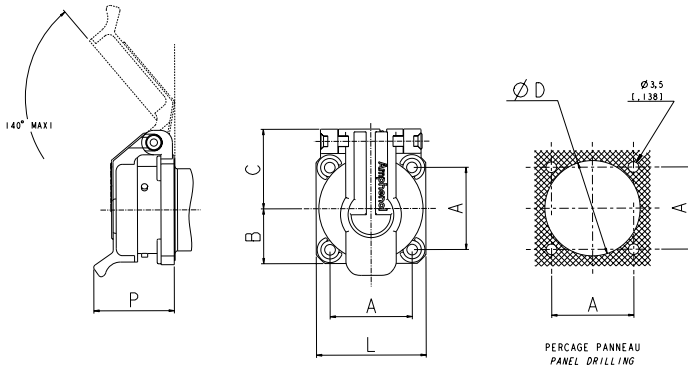

| Shell size <i>Taille du boîtier</i> | P | A | B | C | L | D +0 -0.3 |
|--|----|-------|------|------|------|-----------------|
| 8 | 23 | 15.09 | 12 | 20 | 23.6 | 13 |
| 10 | 24 | 18.26 | 15.5 | 22.5 | 26.7 | 16.2 |
| 12 | 24 | 20.62 | 17.5 | 24 | 29 | 19.4 |
| 14 | | | | | | |
| 15 | | | | | | |
| 18 | 27 | 26.97 | 18.5 | 26.5 | 37 | 28.9 |

Our Self Closing Caps are available with the following inserts:

Nos bouchons automatiques SCC sont disponibles avec les arrangements suivants :

- ① Insert arrangement reference / *Arrangements de contacts*
- ② Number of contacts / *Nombre de contacts*
- ③ Contact size / *Taille des contacts*

| | | | | | | |
|----|---|----|----|----|----|----|
| 08 | ① | | | | | |
| | ② | 2 | 3 | 3 | 3 | 4 |
| | ③ | 20 | 20 | 20 | 20 | 20 |
| 10 | ① | | | | | |
| | ② | 6 | 6 | 7 | | |
| | ③ | 20 | 20 | 20 | | |
| 12 | ① | | | | | |
| | ② | 3 | 8 | 10 | 14 | |
| | ③ | 16 | 20 | 20 | 20 | |
| 14 | ① | | | | | |
| | ② | 2 | 1 | 1 | 1 | 1 |
| | ③ | 5 | 8 | 14 | 18 | 19 |
| | ④ | 16 | 20 | 20 | 20 | 20 |
| 16 | ① | | | | | |
| | ② | 2 | 1 | 1 | | |
| | ③ | 8 | 22 | 26 | | |
| | ④ | 16 | 20 | 16 | | |
| 18 | ① | | | | | |
| | ② | 11 | 29 | 32 | | |
| | ③ | 16 | 20 | 20 | | |

C: Available in crimp version
C: Disponible en version à sertir







P: For those arrangements, please contact us for available configurations. Only available with PT marking
P: Pour ces arrangements, nous consulter pour les configurations possibles. Marquage PT seulement

Top-runners / Les plus standard

Contacts and sealing plugs / *Contacts et obturateurs*





Crimp contacts are delivered with the connector and are mentioned here as spare parts.

Les contacts à sertir sont livrés avec le connecteur et sont mentionnés ici en tant que pièces détachées.

| Designation <i>Désignation</i> | Pictures <i>Photos</i> | Part number <i>Référence</i> |
|---|---|---------------------------------|
| Size 20 pin contact <i>Contact mâle taille 20</i> |  | 800 600 |
| Size 20 socket contact <i>Contact femelle taille 20</i> |  | 800 946 |
| Size 16 pin contact <i>Contact mâle taille 16</i> |  | 800 620 |
| Size 16 socket contact <i>Contact femelle taille 16</i> |  | 800 635 |
| Reducing sleeve for size 20 crimp contact <i>Manchon réducteur pour contact taille 20 à sertir</i> |  | 800 609 |
| Sealing plug size 20 <i>Obturateur taille 20</i> |  | 900 021 |
| Sealing plug size 16 <i>Obturateur taille 16</i> |  | 900 020 |

Dummy receptacle, panel gasket, plastic dust cap

Embase de repos, joint de panneau, bouchon de protection plastique



| Shell size <i>Taille du boîtier</i> | Dummy receptacle <i>Embase de repos</i> | Panel gasket for square flange receptacle (thickness: 0.6 mm) <i>Joint de panneau pour embase carrée (ép: 0,6mm)</i> | | Plastic dust cap for plug <i>Bouchon de protection plastique pour fiche</i> | Plastic dust cap for receptacle <i>Bouchon de protection plastique pour embase</i> |
|--|---|---|--|--|---|
| |  | Standard  | Conductive/ Conducteur  |  |  |
| 8 | FE 08 | JE 8 | JE 8S | 606 061 | 805 411 |
| 10 | FE 10 | JE 10 | JE 10S | 805 413 | 805 412 |
| 12 | FE 12 | JE 12 | JE 12S | 606 064 | 805 413 |
| 14 | FE 14 | JE 14 | JE 14S | 606 073 | 805 414 |
| 16 | FE 16 | JE 16 | JE 16S | 606 066 | 805 415 |
| 18 | FE 18 | JE 18 | JE 18S | 606 067 | 805 416 |
| 20 | FE 20 | JE 20 | JE 20S | 606 068 | 805 417 |
| 22 | FE 22 | JE 22 | JE 22S | 606 069 | 805 418 |
| 24 | FE 24 | JE 24 | JE 24S | 606 079 | 606 069 |

Heatshrink moulded piece for rear accessory

Manchon thermorétractable pour raccord arrière



Heatshrink moulded pieces compatible with following rear accessories: **SQ, J** (backshell delivered with the connector) / **PTSA** (backshell delivered separately):

*Pièces moulées thermorétractables compatibles avec les accessoires arrière suivants : **SQ, J** (raccord livré avec le connecteur) / **PTSA** (raccord livré séparément) :*

| Shell size <i>Taille du boîtier</i> | 8 | 10 | 12 | 14 | 16 | 18 | 20 | 22 | 24 | |
|---|--------|--------|--------|--------|--------|--------|--------|--------|--------|---|
| Straight piece <i>Pièce droite</i> | 804221 | 804222 | 804223 | 804223 | 804225 | 804225 | 804227 | 804227 | 804229 |  |
| Right angle piece <i>Pièce coudée</i> | 804231 | 804232 | 804233 | 804233 | 804235 | 804235 | 804237 | 804237 | 804239 |  |

Heatshrink moulded pieces compatible with **PT06G** and **PT08G** connectors:

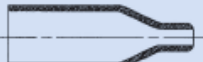
*Pièces moulées thermorétractables compatibles avec les connecteurs **PT06G** et **PT08G** :*

| Shell size <i>Taille du boîtier</i> | 8 | 10 | 12 | 14 | 16 | 18 | 20 | 22 | |
|---|--------|--------|--------|--------|--------|--------|--------|--------|--|
| Straight piece <i>Pièce droite</i> | 804201 | 804202 | 804203 | 804203 | 804205 | 804206 | 804206 | 804206 |  |
| Right angle piece <i>Pièce coudée</i> | - | 804213 | 804213 | 804214 | 804214 | 804216 | 804216 | 804218 |  |

Note: Heatshrink moulded pieces are not pre-glued.

Note : Les pièces moulées thermorétractables ne sont pas pré-encollés.

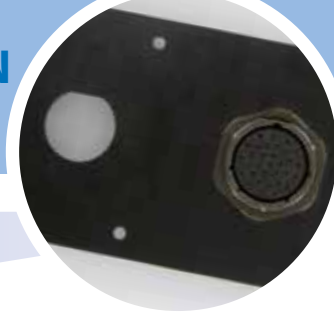

Panel drilling / Perçage de panneau

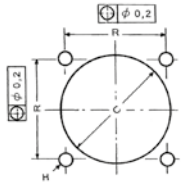

00 Shell type:
rear or front panel mounting

Type de boîtier 00 : montage par l'arrière ou l'avant du panneau.

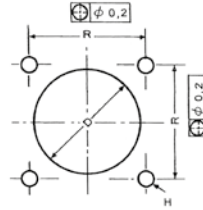

02 Shell type:
front panel mounting

Type de boîtier 02 :
montage par l'avant du panneau.

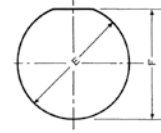

07 Shell type:
rear panel mounting

Type de boîtier 07 :
montage par l'arrière du panneau.

02 Shell type:
rear panel mounting.

Type de boîtier 02 : montage par l'arrière du panneau.

| Shell size Taille du boîtier | C min. | D +0 -0.3 | E +0.3 -0 | F +0 -0.3 | H | R |
|---------------------------------|--------|-----------------|-----------------|-----------------|-----|-------|
| 8 | 14.3 | 13.0 | 14.5 | 13.8 | 3.5 | 15.10 |
| 10 | 17.3 | 16.2 | 17.7 | 17.0 | 3.5 | 18.26 |
| 12 | 21.8 | 19.4 | 22.5 | 21.1 | 3.5 | 20.62 |
| 14 | 25.0 | 22.5 | 25.6 | 24.3 | 3.5 | 23.01 |
| 16 | 28.1 | 25.7 | 28.8 | 27.5 | 3.5 | 24.61 |
| 18 | 31.3 | 28.9 | 32.0 | 30.7 | 3.5 | 26.97 |
| 20 | 34.5 | 32.1 | 35.2 | 33.9 | 3.5 | 29.36 |
| 22 | 37.7 | 35.2 | 38.3 | 37.1 | 3.5 | 31.75 |
| 24 | 40.9 | 38.4 | 41.5 | 40.0 | 4.0 | 34.92 |

Panel thickness / Épaisseur de panneau

| Shell size Taille du boîtier | Square flange receptacle (02) (Rear panel mounting) Embase à collerette carrée (02) (Montage par l'arrière) | Jam nut receptacle (07) Embase à fixation par écrou (07) | |
|---------------------------------|--|---|------|
| | | min. | max. |
| 8 | 2.5 (max.) | 1.6 | 3.2 |
| 10 | 2.5 (max.) | 1.6 | 3.2 |
| 12 | 2.5 (max.) | 1.6 | 3.2 |
| 14 | 2.5 (max.) | 1.6 | 3.2 |
| 16 | 2.5 (max.) | 1.6 | 3.2 |
| 18 | 2.5 (max.) | 1.6 | 3.2 |
| 20 | 5.6 (max.) | 1.6 | 6.4 |
| 22 | 5.6 (max.) | 1.6 | 6.4 |
| 24 | 5.6 (max.) | 1.6 | 6.4 |

Coupling torque value / Couple de serrage

| Shell size Taille du boîtier | Torque value max. Couple max. (N.m) | Shell size Taille du boîtier | Torque value Couple (N.m) | Tolerance Tolérance (N.m) |
|---------------------------------|---|---------------------------------|---------------------------------|---------------------------------|
| 8 | 2.5 | 8 | 4 | ± 0.5 |
| 10 | 4 | 10 | 6 | ± 0.5 |
| 12 | 5 | 12 | 8 | ± 1 |
| 14 | 7 | 14 | 10 | ± 1 |
| 16 | 9 | 16 | 10 | ± 1 |
| 18 | 10 | 18 | 13 | ± 1 |
| 20 | 11 | 20 | 13 | ± 1 |
| 22 | 12 | 22 | 13 | ± 1 |
| 24 | 13 | 24 | 13 | ± 1 |

Central jam nut of PT07 / Ecrou central PT07

Backshell / Raccord arrière

all dimensions are in mm

Printed circuit drillings / *Perçage des circuits imprimés*

On the following drilling layouts the contact identification is viewed mating side of the male connector or cabling side of the female connector. The drillings are symmetrical about the vertical axis of the figure. The tolerance of the hole positions is 0.1 mm of the theoretical position.

Hole size : 1 mm (sizes 20 and 16)

Sur les plans de perçage suivants, le repérage des contacts est vu côté enfichage du connecteur mâle ou côté câblage du connecteur femelle. Les perçages sont symétriques par rapport à l'axe vertical de la figure. La tolérance de positionnement des trous est à 0,1 mm de la position théorique.

Diamètre des trous de perçage : 1 mm (tailles 20 et 16)

8-3A

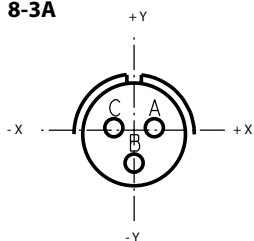

| Contact | x (mm) | y (mm) |
|---------|--------|--------|
| A | + 1,65 | + 0,97 |
| B | 0 | - 1,91 |
| C | - 1,65 | + 0,97 |

8-4

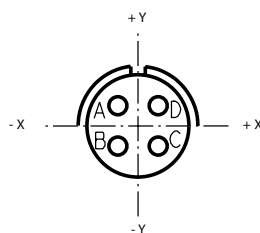

| Contact | x (mm) | y (mm) |
|---------|--------|--------|
| A | - 1,42 | + 1,42 |
| B | - 1,42 | - 1,42 |
| C | + 1,42 | - 1,42 |
| D | + 1,42 | + 1,42 |

10-6

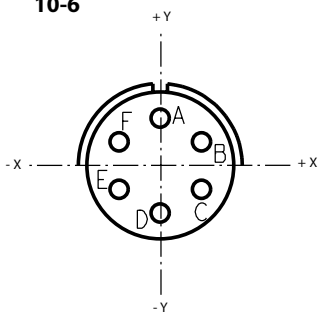

| Contact | x (mm) | y (mm) |
|---------|--------|--------|
| A | 0 | + 3,30 |
| B | + 2,87 | + 1,65 |
| C | + 2,87 | - 1,65 |
| D | 0 | - 3,30 |
| E | - 2,87 | - 1,65 |
| F | - 2,87 | + 1,65 |

12-3

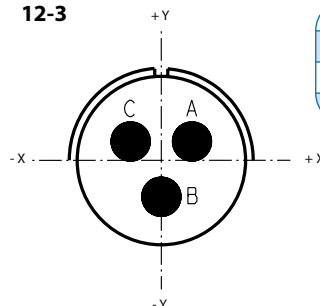

| Contact | x (mm) | y (mm) |
|---------|--------|--------|
| A | + 2,39 | + 1,47 |
| B | 0 | - 2,82 |
| C | - 2,39 | + 1,47 |

12-10

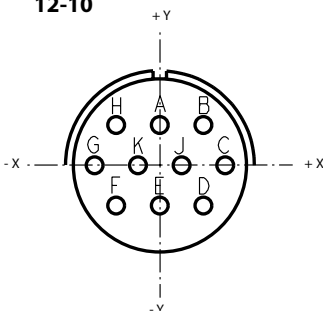

| Contact | x (mm) | y (mm) |
|---------|--------|--------|
| A | 0 | + 3,05 |
| B | + 3,30 | + 3,05 |
| C | + 4,95 | 0 |
| D | + 3,30 | - 3,05 |
| E | 0 | - 3,05 |
| F | - 3,30 | - 3,05 |
| G | - 4,95 | 0 |
| H | - 3,30 | + 3,05 |
| J | + 1,65 | 0 |
| K | - 1,65 | 0 |

12-14

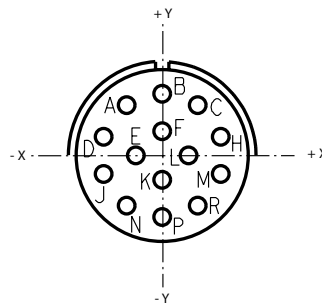

| Contact | x (mm) | y (mm) |
|---------|--------|--------|
| A | - 2,72 | + 3,84 |
| B | 0 | + 4,70 |
| C | + 2,72 | + 3,84 |
| D | - 4,47 | + 1,42 |
| E | - 2,01 | 0 |
| F | 0 | + 1,85 |
| H | + 4,47 | + 1,42 |
| J | - 4,47 | - 1,42 |
| K | 0 | - 1,85 |
| L | + 2,01 | 0 |
| M | + 4,47 | - 1,42 |
| N | - 2,72 | - 3,84 |
| P | 0 | - 4,70 |
| R | + 2,72 | - 3,84 |

14-19

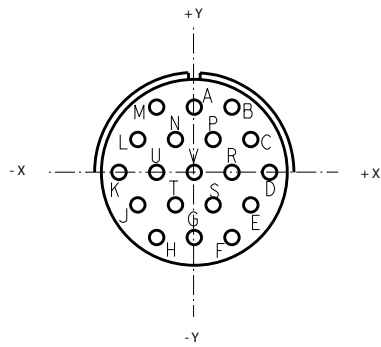

| Contact | x (mm) | y (mm) |
|---------|--------|--------|
| A | 0 | + 5,72 |
| B | + 3,30 | + 5,72 |
| C | + 4,95 | + 2,87 |
| D | + 6,60 | 0 |
| E | + 4,95 | - 2,87 |
| F | + 3,30 | - 5,72 |
| G | 0 | - 5,72 |
| H | - 3,30 | - 5,72 |
| J | - 4,95 | - 2,87 |

| | | |
|---|--------|--------|
| K | - 6,60 | 0 |
| L | - 4,95 | + 2,87 |
| M | - 3,30 | + 5,72 |
| N | - 1,65 | + 2,87 |
| P | + 1,65 | + 2,87 |
| R | + 3,30 | 0 |
| S | + 1,65 | - 2,87 |
| T | - 1,65 | - 2,87 |
| U | - 3,30 | 0 |
| V | 0 | 0 |

16-8

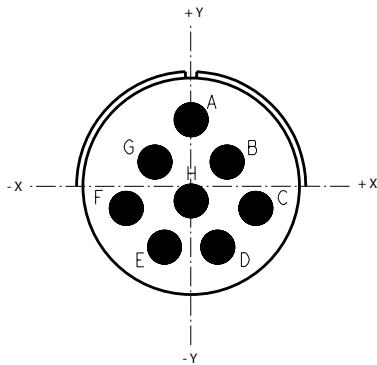

| Contact | x (mm) | y (mm) |
|---------|--------|--------|
| A | 0 | + 5,99 |
| B | + 3,25 | + 2,18 |
| C | + 5,84 | - 1,98 |
| D | + 2,39 | - 5,49 |
| E | - 2,39 | - 5,49 |
| F | - 5,84 | - 1,98 |
| G | - 3,25 | + 2,18 |
| H | 0 | - 1,32 |

16-26

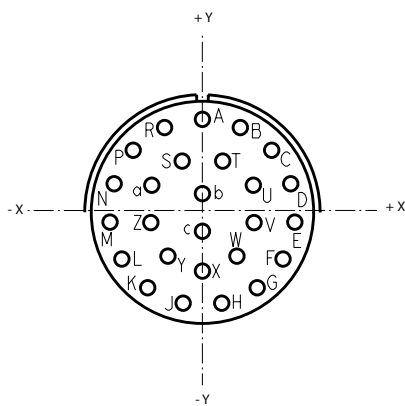

| Contact | x (mm) | y (mm) |
|---------|--------|--------|
| A | 0 | + 8,15 |
| B | + 3,33 | + 7,44 |
| C | + 6,07 | + 5,44 |
| D | + 7,75 | + 2,51 |
| E | + 8,10 | - 0,86 |
| F | + 7,06 | - 4,09 |
| G | + 4,8 | - 6,6 |
| H | + 1,7 | - 7,98 |
| J | - 1,7 | - 7,98 |
| K | - 4,8 | - 6,6 |
| L | - 7,06 | - 4,09 |
| M | - 8,10 | - 0,86 |
| N | - 7,75 | + 2,51 |

| | | |
|---|--------|--------|
| P | - 6,07 | + 5,44 |
| R | - 3,33 | + 7,44 |
| S | - 1,78 | + 4,5 |
| T | + 1,78 | + 4,5 |
| U | + 4,45 | + 2,39 |
| V | + 4,52 | - 0,91 |
| W | + 3,02 | - 3,84 |
| X | 0 | - 5,16 |
| Y | - 3,02 | - 3,84 |
| Z | - 4,52 | - 0,91 |
| a | - 4,45 | + 2,39 |
| b | 0 | + 1,65 |
| c | 0 | - 1,65 |

18-32

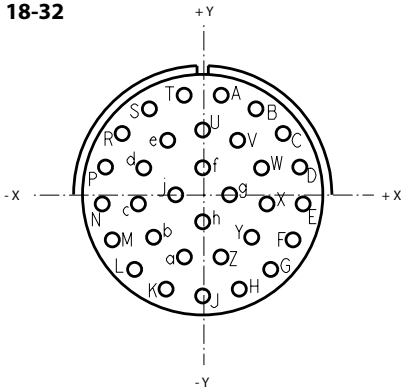

| Contact | x (mm) | y (mm) |
|---------|--------|--------|
| A | +1,68 | +8,97 |
| B | +4,80 | +7,75 |
| C | +7,26 | +5,51 |
| D | +8,76 | +2,49 |
| E | +9,07 | -0,84 |
| F | +8,15 | -4,06 |
| G | +6,15 | -6,73 |
| H | +3,30 | -8,51 |
| J | 0 | -9,12 |
| K | -3,30 | -8,51 |
| L | -6,15 | -6,73 |
| M | -8,15 | -4,06 |
| N | -9,07 | -0,84 |
| P | -8,76 | +2,49 |
| R | -7,26 | +5,51 |
| S | -4,80 | +7,75 |

| | | |
|---|-------|-------|
| T | -1,68 | +8,97 |
| U | 0 | +5,84 |
| V | +3,15 | +4,90 |
| W | +5,31 | +2,41 |
| X | +5,79 | -0,84 |
| Y | +4,42 | -3,84 |
| Z | +1,65 | -5,61 |
| a | -1,65 | -5,61 |
| b | -4,42 | -3,84 |
| c | -5,79 | -0,84 |
| d | -5,31 | +2,41 |
| e | -3,15 | +4,90 |
| f | 0 | +2,44 |
| g | +2,44 | 0 |
| h | 0 | -2,44 |
| j | -2,44 | 0 |

20-41

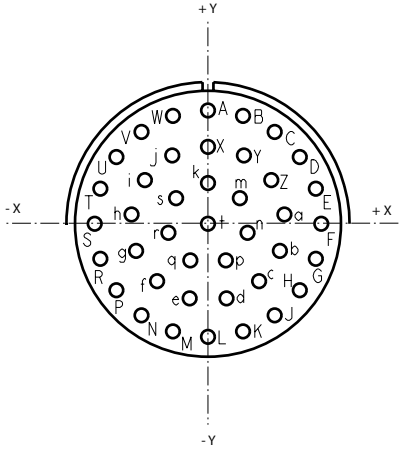

| Contact | x (mm) | y (mm) |
|---------|--------|--------|
| A | 0 | +10,6 |
| B | +3,28 | +10,09 |
| C | +6,23 | +8,58 |
| D | +8,58 | +6,23 |
| E | +10,09 | +3,28 |
| F | +10,6 | 0 |
| G | +10,09 | -3,28 |
| H | +8,58 | -6,23 |
| J | +6,23 | -8,58 |
| K | +3,28 | -10,09 |
| L | 0 | -10,6 |
| M | -3,28 | -10,09 |
| N | -6,23 | -8,58 |
| P | -8,58 | -6,23 |

| | | |
|---|--------|--------|
| R | -10,09 | -3,28 |
| S | -10,6 | 0 |
| T | -10,09 | +3,28 |
| U | -8,58 | +6,23 |
| V | -6,23 | +8,58 |
| W | -3,28 | +10,09 |
| X | 0 | +7,20 |
| Y | +3,35 | +6,38 |
| Z | +5,92 | +4,09 |
| a | +7,15 | +0,87 |
| b | +6,73 | -2,55 |
| c | +4,78 | -5,39 |
| d | +1,73 | -6,99 |
| e | -1,73 | -6,99 |

| | | |
|---|-------|-------|
| f | -4,78 | -5,39 |
| g | -6,73 | -2,55 |
| h | -7,15 | +0,87 |
| i | -5,92 | +4,09 |
| j | -3,35 | +6,38 |
| k | 0 | +3,81 |
| m | +2,98 | +2,38 |
| n | +3,71 | -0,85 |
| p | +1,66 | -3,43 |
| q | -1,66 | -3,43 |
| r | -3,71 | -0,85 |
| s | -2,98 | +2,38 |
| t | 0 | 0 |

22-55

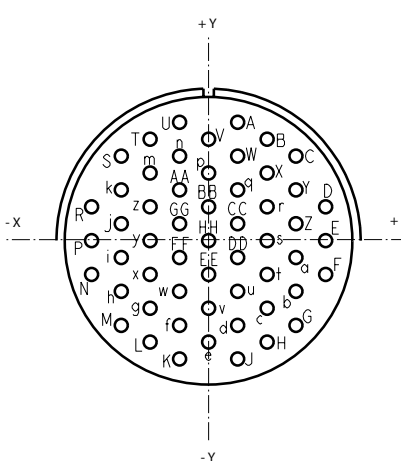

| Contact | x (mm) | y (mm) |
|---------|--------|--------|
| A | +2,84 | +11,56 |
| B | +5,72 | +9,91 |
| C | +8,53 | +8,26 |
| D | +11,43 | +3,30 |
| E | +11,43 | 0 |
| F | +11,43 | -3,30 |
| G | +8,53 | -8,26 |
| H | +5,72 | -9,91 |
| J | +2,84 | -11,56 |
| K | -2,84 | -11,56 |
| L | -5,72 | -9,91 |
| M | -8,53 | -8,26 |
| N | -11,43 | -3,30 |
| P | -11,43 | 0 |
| R | -11,43 | +3,30 |
| S | -8,53 | +8,26 |
| T | -5,72 | +9,91 |
| U | -2,84 | +11,56 |

| | | |
|---|-------|-------|
| V | 0 | +9,91 |
| W | +2,84 | +8,26 |
| X | +5,72 | +6,60 |
| Y | +8,53 | +4,95 |
| Z | +8,53 | +1,65 |
| a | +8,53 | -1,65 |
| b | +8,53 | -4,95 |
| c | +5,72 | -6,60 |
| d | +2,84 | -8,26 |
| e | 0 | -9,91 |
| f | -2,84 | -8,26 |
| g | -5,72 | -6,60 |
| h | -8,53 | -4,95 |
| i | -8,53 | -1,65 |
| j | -8,53 | +1,65 |
| k | -8,53 | +4,95 |
| m | -5,72 | +6,60 |
| n | -2,84 | +8,26 |
| p | 0 | +6,60 |

| | | |
|----|-------|-------|
| q | +2,84 | +4,95 |
| r | +5,72 | +3,30 |
| s | +5,72 | 0 |
| t | +5,72 | -3,30 |
| u | +2,84 | -4,95 |
| v | 0 | -6,60 |
| w | -2,84 | -4,95 |
| x | -5,72 | -3,30 |
| y | -5,72 | 0 |
| z | -5,72 | +3,30 |
| AA | -2,84 | +4,95 |
| BB | 0 | +3,30 |
| CC | +2,84 | +1,65 |
| DD | +2,84 | -1,65 |
| EE | 0 | -3,30 |
| FF | -2,84 | -1,65 |
| GG | -2,84 | +1,65 |
| HH | 0 | 0 |



Tools / Outils

| Designation Désignation | Amphenol Socapex P/N Référence Amphenol Socapex | Military P/N Référence normalisée |
|---|--|--------------------------------------|
| Crimping pliers <i>Pince à sertir</i> | 809857 | M22520/1-01 |
| Locator for pliers 809857 <i>Positionneur pour pince 809857</i> | 809861 | M22520/1-02 |
| Metal contact insertion tool for size 20 contact <i>Outil métallique d'insertion pour contact taille 20</i> | 809709 | - |
| Metal contact insertion tool for size 16 contact <i>Outil métallique d'insertion pour contact taille 16</i> | 809743 | - |
| Metal contact removal tool for size 20 contact (front release) <i>Outil d'extraction métallique pour contact taille 20 (démontage par l'avant)</i> | 809710 | - |
| Metal contact removal tool for size 16 contact (front release) <i>Outil d'extraction métallique pour contact taille 16 (démontage par l'avant)</i> | 809711 | - |
| Termination of size 20 contact removal tool (spare part) <i>Embout de l'outil d'extraction de contact taille 20 (pièce détachée)</i> | 809753 | - |
| Termination of size 16 contact removal tool (spare part) <i>Embout de l'outil d'extraction de contact taille 16 (pièce détachée)</i> | 809773 | - |



Crimping pliers
Pince à sertir





Metal contact insertion tool
Outil d'insertion métallique



Metal contact removal tool
Outil d'extraction métallique

Tools for rear accessory / Outils pour raccord arrière

| Designation Désignation | Amphenol Socapex P/N Référence Amphenol Socapex |
|--|--|
| Tightening pliers for rear accessories <i>Pince de serrage pour raccord arrière</i> | 809720  |
| Tightening support for plug rear accessories (all sizes dummy receptacles on a chassis) <i>Support de serrage pour fiche avec raccord arrière (toutes les tailles d'embase de repos sur un même châssis)</i> | 809717  |

Crimping procedure / *Procédure de sertissage*

Use crimping pliers **M22520/1-01** (Amphenol Socapex P/N: **809857**) and turret **M22520/1-02** (Amphenol Socapex P/N: **809861**). Select the suitable position for your contact by rotating the locator:

- Contact size 20: "red" position
- Contact size 16: "blue" position



*Utiliser la pince à sertir **M22520/1-01** (Ref. Amphenol Socapex : **809857**) et le positionneur **M22520/1-02** (Ref. Amphenol Socapex : **809861**). Placer le positionneur en fonction de la taille du contact utilisé :*

- Contact taille 20 : repère rouge
- Contact taille 16 : repère bleu

Strip the wires carefully to the appropriate length :

- Contact size 20: 5 mm
- Contact size 16: 6 mm

Insert the contact first into the crimp cavity of the tool and then insert the stripped wire into the crimp barrel of the contact. Squeeze the pliers firmly. The handle will not release until the contact is completely crimped.

Ensure that the wire has penetrated correctly by checking that it may be seen through the wire inspection hole of the contact.

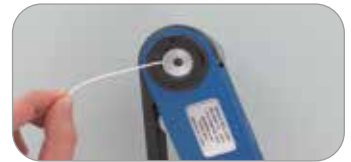

Dénuder les câbles avec précaution aux longueurs suivantes :

- Contact taille 20 : 5 mm
- Contact taille 16 : 6 mm

Insérer en premier le contact dans la cavité de sertissage de l'outil puis insérer le fil dénudé dans le fût de sertissage du contact. Serrez la pince fermement. La pince s'ouvrira d'elle-même dès que le contact sera complètement serti. Faire un contrôle visuel par le trou d'inspection du contact pour s'assurer que le fil est correctement inséré.

Use the suitable insertion tool according to the contact size :

- Contact size 20: **809709**
- Contact size 16: **809743**

Slide the tool over the wire side of the contact until the tool bottoms on the contact. Introduce contacts one by one into the rear of the connector pushing straight until the contact snaps into place and the clip ensures contact retention (begin with the center cavity and work outwards in a circular pattern). Every time, remove the tool carefully.

Fill any unused cavities with contacts unwired. A sealing plug can be inserted into the grommet behind the unused contacts to maintain the sealing integrity of the connector.



Utiliser l'outil d'insertion correspondant à la taille du contact :

- Contact taille 20 : **809709**
- Contact taille 16 : **809743**

Glisser l'outil sur la partie cablée du contact, l'extrémité de l'outil prenant appui sur la jupe du contact.

Introduire les contacts un par un par l'arrière du connecteur et pousser régulièrement dans l'axe jusqu'à ce que le contact soit maintenu dans la plaquette de rétention (commencer par les cavités du centre et continuer l'opération circulairement). A chaque fois retirer l'outil avec précaution.

Afin de maintenir l'étanchéité du connecteur, insérer des contacts non câblés dans les cavités non utilisées puis insérer des obturateurs.

Check visually the mating face of the connector to insure that all the contacts are on the same plane (fully inserted). Pull lightly on the wire to ensure that the contact is locked securely.



Faire un contrôle visuel de la face avant du connecteur pour vérifier que tous les contacts sont bien sur un même plan (complètement insérés). Tirer légèrement sur les fils pour vérifier que les contacts sont correctement maintenus.

NOTES

A series of horizontal dotted lines for taking notes, spanning the width of the page.

NOTES

A series of horizontal dotted lines for taking notes, spanning the width of the page.

NOTES

Area with horizontal dotted lines for taking notes.

ABOUT AMPHENOL

Founded in 1932, **Amphenol** is one of the largest manufacturers of interconnect products in the world. The company designs, manufactures, and markets electrical, electronic, and fiber optic connectors, interconnect systems, and coaxial and specialty cables.

Amphenol has a diversified presence as a leader in high growth areas of the interconnect industry and provides solutions for customers in the automotive, broadband, industrial, information technology and data communications, military and aerospace, mobile devices, and mobile networks markets.

More info on www.amphenol.com

Amphenol
ENABLING THE ELECTRONICS REVOLUTION

Amphenol Military & Aerospace Operations (AMAO) has the largest and broadest selection of interconnect products in the military and aerospace markets.

More info on www.amphenolmao.com

Amphenol
MILITARY & AEROSPACE

Europe

| | | | |
|----------------|------------------------------------|--|-------------------|
| FRANCE | Amphenol AIR LB | 2 rue Clément Ader, ZAC de Wé - 08110 Carignan | +33 3 24 22 78 49 |
| FRANCE | Amphenol SEFEE | Z.I. des Cazes – BP243 - 12402 Saint-Affrique Cedex | +33 5 65 98 11 00 |
| GERMANY | Amphenol AIR LB GMBH | Am Kleinbahnhof 4 - 66740 Saarlouis | +49 6831 981 00 |
| ITALY | Amphenol EUROPEAN SALES OPERATIONS | Via Barbaiana n.5 - 20020 Lainate - Milano | +39 293 254 214 |
| UNITED KINGDOM | Amphenol INVOTEC | Unit 1-3, Hedging Lane Industrial Estate, Dosthill - Tamworth, B77 5HH | +44 1827 263 000 |
| UNITED KINGDOM | Amphenol IONIX SYSTEMS | Prospect House, Taylor Business Park, Risleigh, Warrington, WA3 6HP | +44 1 942 685 200 |
| UNITED KINGDOM | Amphenol LTD | Thanet Way, Whitstable - KENT, CT53JF | +44 1227 773 200 |
| UNITED KINGDOM | Amphenol MARTEC | St Augustines Business Park, Swalecliffe Whitstable - Kent CT5 2QJ | +44 1227 793 733 |

North America

| | | | |
|--------|-------------------------------|--|-----------------|
| CANADA | Amphenol CANADA | 605 Milner avenue - Toronto, Ontario | +1 416 291 0647 |
| USA | Amphenol AEROSPACE OPERATIONS | 40-60 Delaware street - Sidney, NY 13838 | +1 800 678 0141 |
| USA | Amphenol BORISH TECHNOLOGIES | 4511 East Paris AVE - Grand Rapids, MI 49512 | +1 616 554 9820 |
| USA | Amphenol FSI | 1300 Central Expwy N, Suite 100 - Allen, TX 75013 | +1 214 547 2400 |
| USA | Amphenol GRIFFITH ENTERPRISES | 6000 East Coury Drive - Cottonwood, AZ 86326 | +1 928 634 3685 |
| USA | Amphenol NEXUS TECHNOLOGIES | 50 Sunnyside Avenue - Stamford, CT 06902 | +1 203 327 7300 |
| USA | Amphenol PCD | 72 Cherry Hill Drive - Beverly, MA. 01915 | +1 978 624 3400 |
| USA | Amphenol PRINTED CIRCUIT | Board Technology, 91 Northeastern Boulevard - Nashua, NH 03062 | +1 603 324 4500 |
| USA | Amphenol SV MICROWAVE | 2400 Centrepark West Drive - West Palm Beach, FL | +1 561 840 1800 |
| USA | Amphenol TIMES MICROWAVE | 358 Hall Avenue - Wallingford, CT 06492 | +1 800 867 2629 |

Asia

| | | | |
|-----------|-----------------------------|--|------------------------|
| CHINA | Amphenol PCD CO. | Building 21, 1 st Liao Keng Industrial Zone, Shi Yan Street - Bao An District - Shenzhen 518108 | +86 755 8173 8000/8286 |
| INDIA | Amphenol INTERCONNECT INDIA | 105 Bhosari Industrial Area - Pune 411 026 | +91 20 27120363 |
| JAPAN | Amphenol JAPAN | 471-1, Deba, Ritto-City - Shiga 520 3041 | +81 77 553 8501 |
| KOREA | Amphenol DAESHIN | 558 SongNae-Dong SoSa-Gu, Bucheon-city, Kyunggi-Do - 420-130 | +81 32 610 3830/3845 |
| SINGAPORE | Amphenol EAST ASIA | 26/F, Railway Plaza, 39 Chatham Road South, Tsim Sha Tsui, Kowloon, Hong Kong | +65 6294 2128 |

Other Areas

| | | | |
|-------------|------------------------|---|-------------------|
| AFRICA | Amphenol AFRICA | 30 Impala Rd - Sandton 2146 | +27 82 410 5179 |
| ARGENTINA | Amphenol ARGENTINA | Av. Callao 930 2do piso Oficina B "Plaza" C1023 - AAP Buenos Aires | +54 11 4815 6886 |
| AUSTRALIA | Amphenol AUSTRALIA PTY | 2 Fiveways Blvd., Keysborough - Melbourne - Victoria 3173 | +61 3 8796 8888 |
| BRAZIL | Amphenol DO BRAZIL | Rua Diogo Moreira, 132, 20 andar, rooms 2001-2-3 | +55 11 3815 1003 |
| ISRAEL | Amphenol BAR-TEC | 3 Hagavish Street, K fir-Barkan Bldg. East Industrial Zone - Kfar-Sava, 44102 | +972 9 764 4100 |
| MEXICO | Amphenol OPTIMIZE | Carretera Internacional Km 6.5, Col. Parque Industrial, Nogales, Sonora, C.P. 84094 | +52 631 311 160 |
| NEW ZEALAND | Amphenol PHITEK | Level 4, 2 Kingdon Street, Newmarket, Auckland 1023 | +64 9 524 2984 |
| RUSSIA | Amphenol RUSSIA | Yaroslavskaja Street 8 - 129164 Moscow | +7 495 937 6341 |
| TURKEY | Amphenol TURKEY | Sun Plaza 15 Kat: 15 Maslak Hah. Bilim Sok. No.5 - Sisli/Istanbul, 34398 | +90 212 367 92 19 |

Amphenol SOCAPEX



Amphenol Socapex

948, promenade de l'Arve BP29
74311 Thyez Cedex - France
Phone: +33 (0)4 50 89 28 00
contact@amphenol-socapex.fr
www.amphenol-socapex.com



For Technical Support

+33 (0)4 50 89 28 49
technicalsupport@amphenol-socapex.fr
www.amphenol-socapex.com/technical_support



To buy our products

+33 (0)4 50 90 28 00
contact@amphenol-socapex.fr
www.amphenol-socapex.com/amphenol/sales
Request a quote online at www.amphenol-socapex.com/quotation_request



Documentation

www.amphenol-socapex.com/documentation
To order a paper version of our catalogs, send an e-mail to communication@amphenol-socapex.fr



www.amphenol-socapex.com

Follow Amphenol Socapex on social media :    

This catalog uses paper from managed forests, PEFC & FSC labels, and is printed by a printer certified "Imprim'Vert®"

*We reserve the right to modify our products in any way we deem necessary.
Any duplication is prohibited, unless approved in writing.*

Designed by **Amphenol Socapex**
DOC-000028-ANG - April 2021