

PKH.EP.E3.I

Pneumatisch automatisierter 2-Wege-Edelstahl-Kugelhahn mit dreiteiligem Gehäuse in den Baugrößen DN15 bis DN80 für vielfältige industrielle und allgemeine Anwendungen.

Mit pneumatischen Schwenkantrieben in doppelwirkender und einfachwirkender, mit Federkraft schließender oder öffnender, Funktion lieferbar.

Auf Wunsch auch mit Anschweißenden oder Flanschen.



Technische Daten

NENNWEITE

DN15 (1/2") bis DN80 (3")

NORMEN

- Anschluss: Innengewinde Rp gem. ISO 7/1
- Aufbaufansch ISO 5211
- Baulänge DIN 3203 - M3

MEDIEN

Neutrale Gase und Flüssigkeiten, weitere Medien auf Anfrage.
 Bei aggressiven Medien Werkstoffbeständigkeitstabelle beachten.
 Bestimmte Medien können zu Veränderung des Betätigungsmomentes führen.

DURCHFLUSSRICHTUNG

Beliebig

WERKSTOFFE

- Gehäuse und Gewindestutzen: 1.4408
- Kugel und Schaltwelle: 1.4401
- Kugel- und Schaltwellendichtung: PTFE, glasfaserverstärkt

TEMPERATUR

-10° bis +200°C (abhängig vom Betriebsdruck)

DRUCK-/TEMPERATURDIAGRAMM

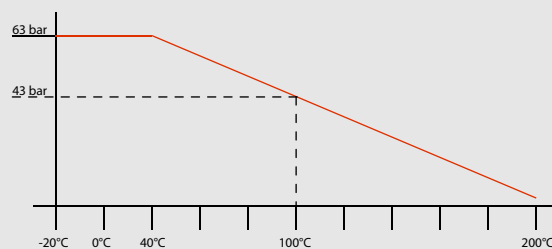

BETÄTIGUNG

Mit pneumatischem Schwenkantrieb in doppel- oder einfachwirkender (Federkraft öffnend oder schließend) Ausführung.

STEUERDRUCK / STEUERMEDIUM

5,5 bar gefilterte Druckluft nach PNEUROP/ISO Klasse 4, weitere Steuerdrücke und Medien auf Anfrage.





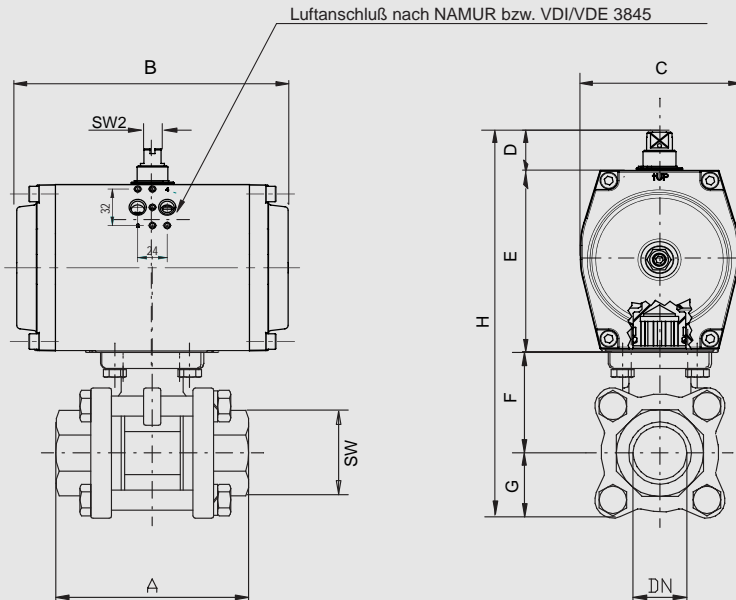





















OPTIONEN

- 3/2- oder 5/2-Wege-Steuerventil
- Stellungsregler
- Mechanische oder induktive Endlagenrückmeldung



PKH.EP.E3.I	Nennweite [mm] Anschluss [mm]		max. Druck [bar]	M(1) + 30% [Nm]	Flansch	4-Kant	Pneumatischer Stellantrieb	Baumaße [mm] und Gewichte [kg]										Artikel Nr.	Ident Nr.	
	DN	Rp						PN	A	B	C	D	E	F	G	H	SW 1			SW 2
doppeltwirkend	15	1/2"	63	69,1	F03/F04	9	GTKB.52x90	75	133	68,5	30	74	40	24	168	29	10	1,70	350.510	103595
	15	1/2"	63	69,1	F03/F04	9	GTKB.43x90	75	116	61,5	30	65	40	24	159	29	10	1,40	350.510/1	103596
	20	3/4"	63	11,7	F03/F04	9	GTKB.52x90	80	133	68,5	30	74	44	27	175	35	10	1,80	350.511	103597
	20	3/4"	63	11,7	F03/F04	9	GTKB.43x90	80	116	61,5	30	65	44	27	166	35	10	1,50	350.511/1	103598
	25	1"	63	16,9	F04/F05	11	GTKB.63x90	90	133	68,5	30	77	50	30	187	41	10	2,80	350.512	103599
	32	1 1/4"	63	26,0	F04/F05	11	GTKB.63x90	110	137	80,0	30	88	58	37	213	50	10	3,50	350.513	103600
	40	1 1/2"	63	36,4	F05/F07	14	GTKB.63x90	120	137	80,0	30	88	68	40	226	58	10	4,40	350.514	103601
	50	2"	63	48,1	F05/F07	14	GTKB.75x90	140	161	92,5	30	100	77	50	257	74	10	6,85	350.515	103602
	65	2 1/2"	63	63,7	F07/F10	17	GTKB.83x90	185	180	99,5	30	108	98	62	298	89	10	12,0	350.516	103603
80	3"	63	70,2	F07/F10	17	GTKB.92x90	205	209	110,5	30	117	110	82	339	104	14	17,6	350.517	103604	
einfachwirkend, federschließend	15	1/2"	63	9,1	F03/F04	9	GTKB.52x90.09	75	133	68,5	30	74	40	24	168	24	10	1,85	350.520	103605
	15	1/2"	63	9,1	F03/F04	9	GTKB.43x90.09	75	116	61,5	30	65	40	24	159	24	10	1,60	350.520/1	103606
	20	3/4"	63	11,7	F03/F04	9	GTKB.52x90.10	80	133	68,5	30	74	44	27	175	30	10	1,90	350.521	103607
	25	1"	63	16,9	F04/F05	11	GTKB.63x90.10	90	137	80,0	30	88	52	33	203	37	10	2,95	350.522	103608
	32	1 1/4"	63	26,0	F04/F05	11	GTKB.75x90.10	110	161	92,5	30	100	58	37	225	40	10	4,50	350.523	103609
	40	1 1/2"	63	36,4	F05/F07	14	GTKB.83x90.10	120	180	92,5	30	100	68	40	238	54	10	5,95	350.524	103610
	50	2"	63	48,1	F05/F07	14	GTKB.92x90.10	140	209	110,5	30	117	77	50	274	68	14	9,90	350.525	103611
	65	2 1/2"	63	63,7	F07/F10	17	GTKB.110x90.08	185	221	120,0	30	140	98	60	328	85	14	15,7	350.526	103612
80	3"	63	70,2	F07/F10	17	GTXB.110x90.10	205	221	120,0	30	140	110	67	347	100	14	20,4	350.527	103613	

(1) = Losbrechmoment der Armatur inklusive Sicherheitsaufschlag 30%. (2) = Bitte bei xx die gewünschte Federrückstellung NC (normal geschlossen) oder NO (normal geöffnet) angeben. (3) = SW Angabe in mm

Schaltstellungen 3-Wege-Kugelhähne mit pneumatischen Stellantrieb			
Variante	Grundstellung 0°	Dreh- richtung	Schaltstellung 90°
L1			
L2			
T1			
T2			
T3			
T4			
T5			
T6			
T7			
T8	