



# PMD 16K, 17K SERIES

## 225 WATT (20 AMP CONTINUOUS, 40 AMP PEAK)



### FEATURES

- Electrical specifications guaranteed for operating junction temperature range of 0 - 200°C
- Guaranteed and 100% tested for  $I_{SB}$  (Secondary Breakdown Current) insuring maximum performance at high energy levels
- Low thermal resistance for more useable power and lower operating temperatures
- Hermetically sealed

### DESCRIPTION

The PMD 16K Series of devices are three-terminal NPN Darlington Power Transistors. The PMD 17K Series of devices are PNP Darlington Power Transistors. These devices are monolithic epitaxial base structures with built-in base to emitter shunt resistors. The devices are CVD glass passivated to increase reliability and provide reduced high-temperature reverse leakage current. This important feature enables this series of Darlington devices to meet guaranteed operating junction temperatures of 200°C. Internal diode protection (D1) of the Darlington configuration is built into the structure to limit the device power dissipation during negative overshoot.

### ABSOLUTE MAXIMUM RATINGS

PARAMETER	SYMBOL	MAXIMUM	UNITS
Collector Emitter Voltage PMD16K, 17K80 PMD16K, 17K100	$V_{CEO}$	80 100	Vdc
Collector Base Voltage PMD16K, 17K80 PMD16K, 17K100	$V_{CBO}$	80 100	Vdc
Emitter Base Voltage	$V_{EBO}$	5	Vdc
Collector Current Continuous Peak	$I_C$	20 40	Adc
Base Current	$I_B$	0.5	Adc
Thermal Resistance	$\theta_{JC}$	0.67	°C/Watt
Total Internal Power Dissipation @ $T_C = 50^\circ C^1$	$P_D$	225	Watts
Operating Junction and Storage Temperature	$T_J$ $T_{STG}$	- 65 to + 200	°C

<sup>(1)</sup> For operation above  $T_C = 50^\circ C$ , derate @ 1.5 W/°C.

### DEVICE SELECTION GUIDE

DEVICE	VOLTAGE RATING	POLARITY
PMD16K80	80V	NPN
PMD16K100	100V	NPN
PMD17K80	80V	PNP
PMD17K100	100V	PNP

Excellent thermal resistance junction to case ( $\theta_{JC}$ ) provides for more useable power at lower operating temperatures. This, coupled with 100%  $I_{SB}$  testing, insures optimum performance and durability for DC motor control and other complementary Darlington applications. These Darlington devices are hermetically sealed copper/steel TO-3 packages providing high reliability and low thermal resistance.

# PMD 16K, 17K SERIES

## ELECTRICAL CHARACTERISTICS

All parameters are guaranteed at  $T_J = 0$  to  $200^\circ\text{C}$ , unless otherwise specified.

Parameter	Symbol	Test Conditions	Minimum	Maximum	Units
<b>ON CHARACTERISTICS</b>					
Collector Emitter Saturation Voltage <sup>1</sup>	$V_{CE(sat)}$	$I_C = 10 \text{ Adc}; I_B = 40 \text{ mAdc}$		2.0	Vdc
Base Emitter Turn-on Voltage <sup>1</sup>	$V_{BE(on)}$	$I_C = 10 \text{ Adc}; V_{CE} = 3 \text{ Vdc}$		2.8	Vdc
Base Emitter Saturation <sup>1</sup>	$V_{BE(sat)}$	$I_C = 10 \text{ Adc}; I_B = 40 \text{ mAdc}$		2.8	Vdc
DC Current Gain <sup>1</sup> PMD16K80, 100 PMD17K80, 100	$h_{FE}$	$I_C = 10 \text{ Adc}; V_{CE} = 3 \text{ Vdc}$ $T_J = 25^\circ\text{C}$	1000 800	20,000 20,000	
Forward Bias Secondary Breakdown Current	$I_{s/b}$	$V_{CE} = 30 \text{ Vdc}; T_A = 25^\circ\text{C}$ 1 sec non-repetitive pulse	7.5		Adc
<b>OFF CHARACTERISTICS</b>					
Collector Emitter Breakdown Voltage <sup>1</sup> (Base Open) PMD16K, 17K80 PMD16K, 17K100	$V_{(BR)CEO}$	$I_{CE} = 100 \text{ mAdc}; T_J = 25^\circ\text{C}$	80 100		Vdc
Collector Emitter Sustaining Voltage <sup>1</sup> PMD16K, 17K80 PMD16K, 17K100	$V_{(SUS)CER}$	$I_{CE} = 100 \text{ mAdc}; R_{BE} = 2.2\text{k}\Omega$	80 100		Vdc
Emitter Base Leakage Current	$I_{EBO}$	$V_{EB} = 5 \text{ Vdc}; I_C = 0\text{A}$		3.0	mAdc
Collector Emitter Leakage Current PMD16K, 17K80 PMD16K, 17K100	$I_{CER}$	$V_{CE} = 54 \text{ Vdc}; R_{BE} = 2.2\text{k}\Omega$ $V_{CE} = 67 \text{ Vdc}; R_{BE} = 2.2\text{k}\Omega$		7.0 7.0	mAdc
<b>DYNAMIC CHARACTERISTICS</b>					
Output Capacitance	$C_{ob}$	$V_{CB} = 10 \text{ Vdc}; I_E = 0 \text{ Adc}$ $f = 1 \text{ MHz}; T_J \geq 25^\circ\text{C}$		400	pF
Small Signal Current Gain	$h_{fe}$	$I_C = 7 \text{ Adc}; V_{CE} = 3 \text{ Vdc}$ $f = 1 \text{ kHz}; T_J = 25^\circ\text{C}$	300		
Common Emitter Short Circuit Forward Transfer Ratio	$ h_{fe} $	$I_C = 7 \text{ Adc}; V_{CE} = 3 \text{ Vdc}$ $f = 1 \text{ MHz}; T_J = 25^\circ\text{C}$	4		

(1) Pulse tested with pulse width  $\leq 300 \mu\text{s}$  and duty cycle  $\leq 2.0\%$ .

# PMD 16K, 17K SERIES

## OPERATIONAL DATA

**POWER DERATING  
(PMD 16K, 17K SERIES)**

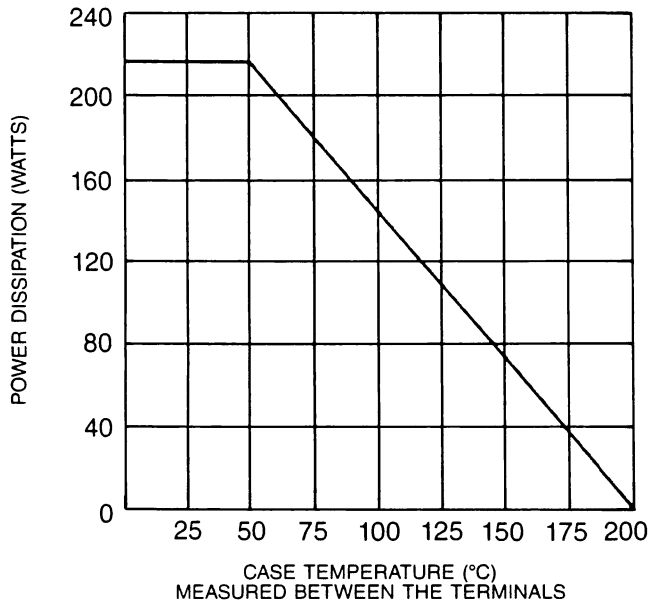

**SAFE OPERATING AREA  
(PMD 16K, 17K SERIES)**

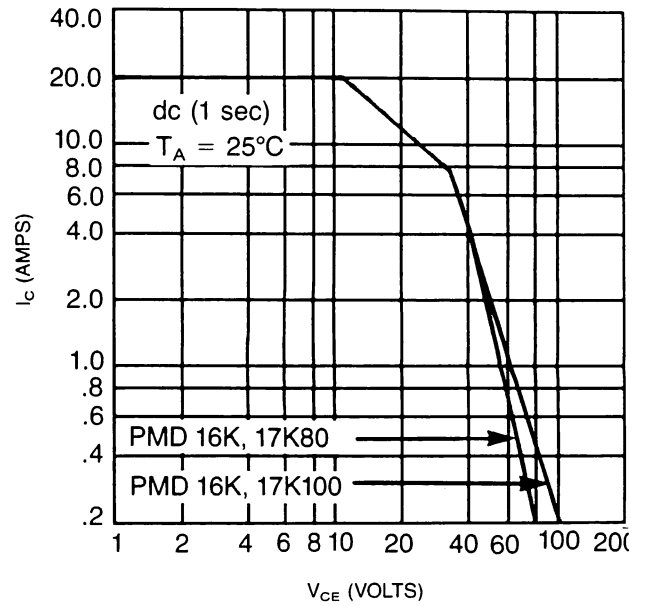

**FORWARD VOLTAGE OF D1  
(PMD 16K SERIES)**

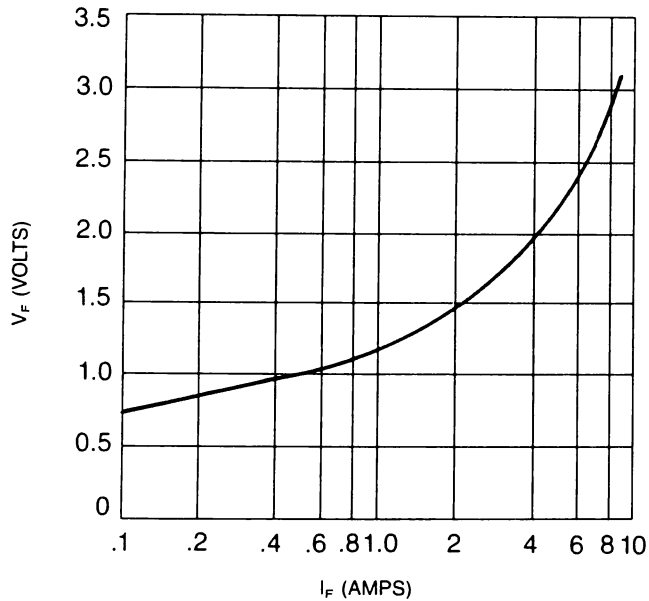

**FORWARD VOLTAGE OF D1  
(PMD 17K SERIES)**

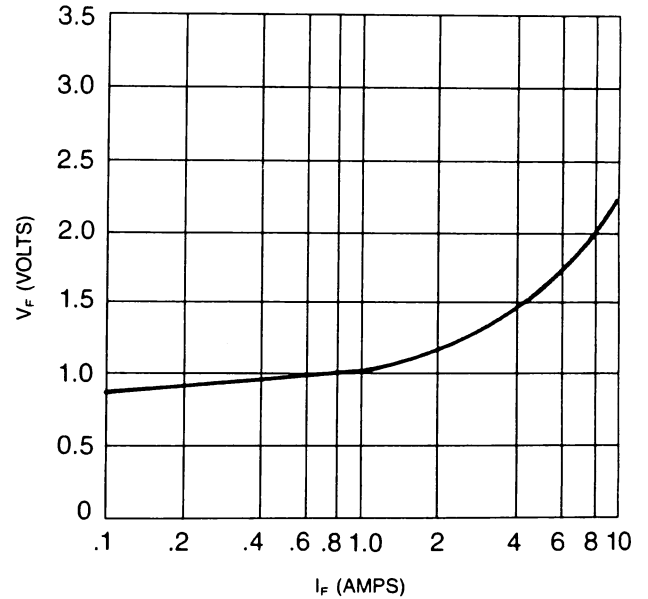

# PMD 16K, 17K SERIES

## OPERATIONAL DATA

**ON VOLTAGE VS  
COLLECTOR CURRENT  
(PMD 16K SERIES)**

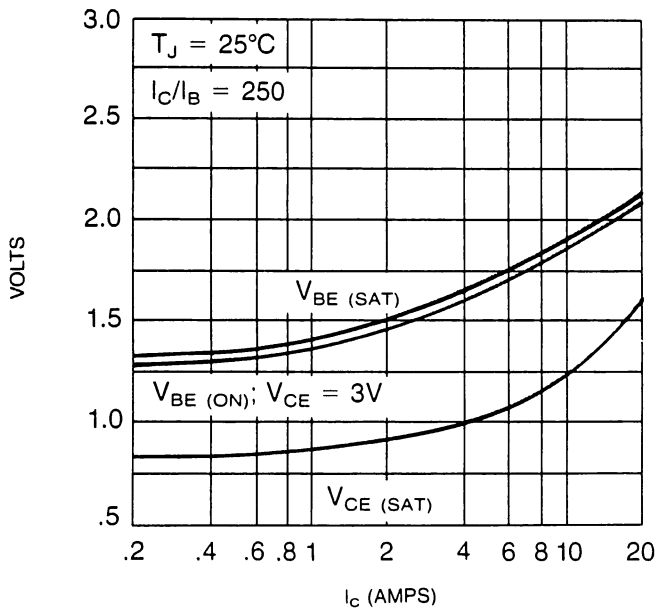

**ON VOLTAGE VS  
COLLECTOR CURRENT  
(PMD 17K SERIES)**

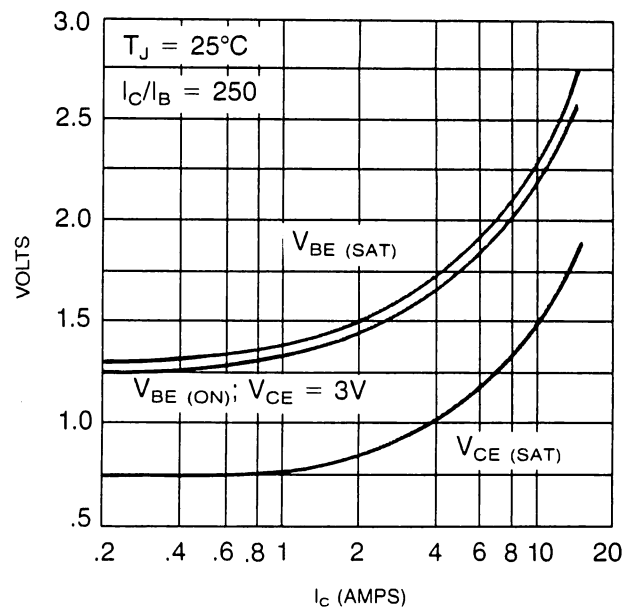

**DC COLLECTOR CURRENT GAIN  
VS COLLECTOR CURRENT  
(PMD 16K SERIES)**

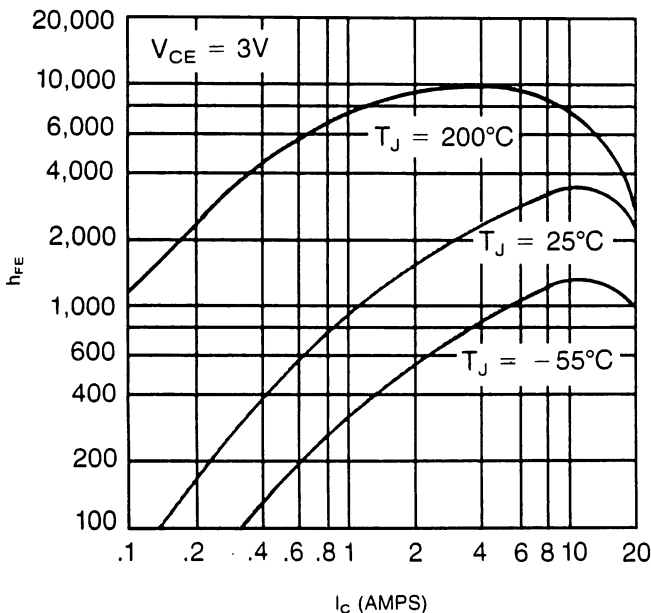

**DC COLLECTOR CURRENT GAIN  
VS COLLECTOR CURRENT  
(PMD 17K SERIES)**

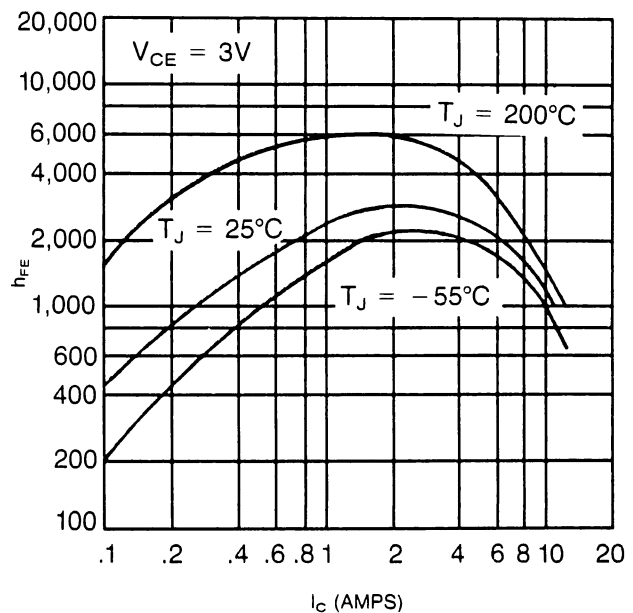

# PMD 16K, 17K SERIES

## OPERATIONAL DATA

COLLECTOR SATURATION REGION  
(PMD 16K SERIES)

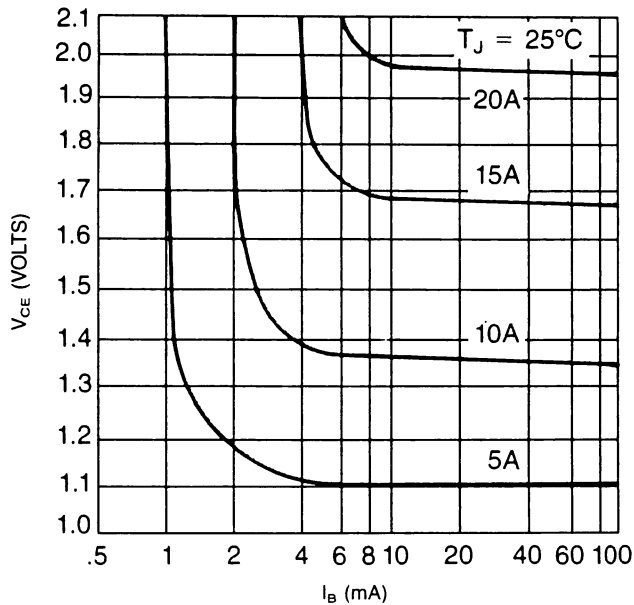

COLLECTOR SATURATION REGION  
(PMD 17K SERIES)

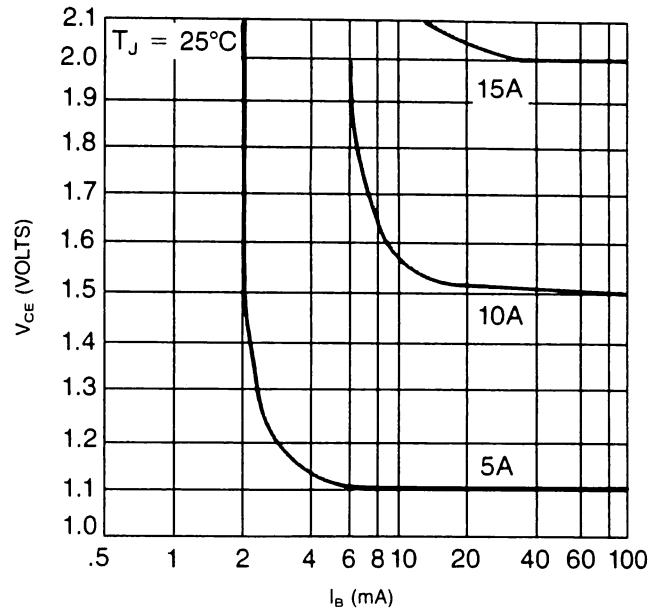

## BLOCK DIAGRAMS

NPN

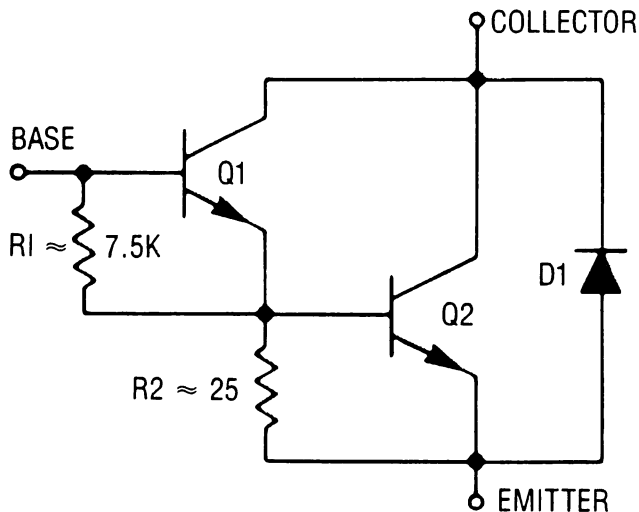

PNP

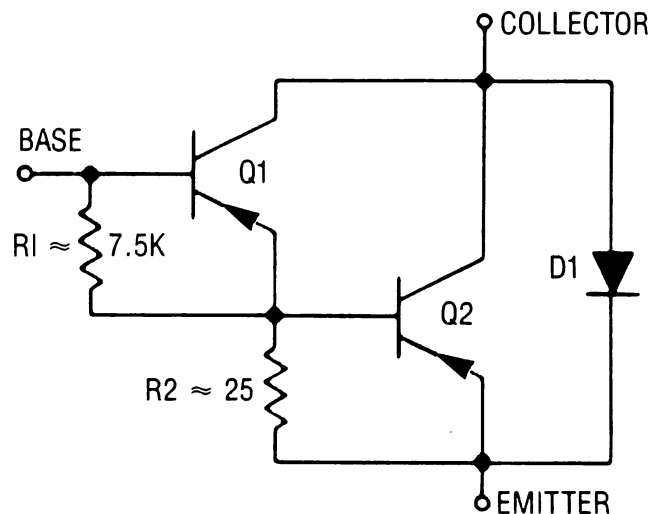

# PMD 16K, 17K SERIES

## DEVICE OUTLINE

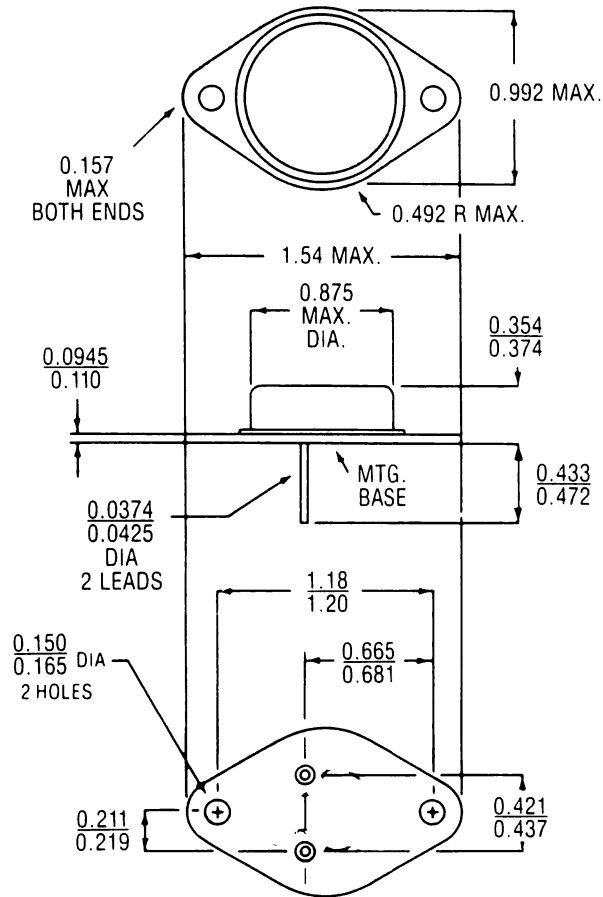

**Bottom View**

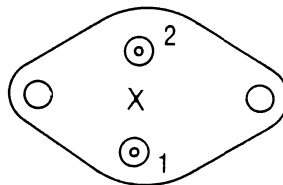

1 — Base  
2 — Emitter  
Case Is Collector