

---

## SAM R30 Xplained Pro

---

### Description

---

The SAM R30 Xplained Pro is a hardware platform designed to evaluate the ATSAMR30G18A SoC. This kit is supported by Atmel Studio, an integrated development platform, which provides predefined application examples. This kit provides easy access to various features of the ATSAMR30G18A SoC, and offers additional peripherals to extend the features of the board and ease the development of custom designs.

**Figure 1. SAM R30 Xplained Pro Evaluation Kit**

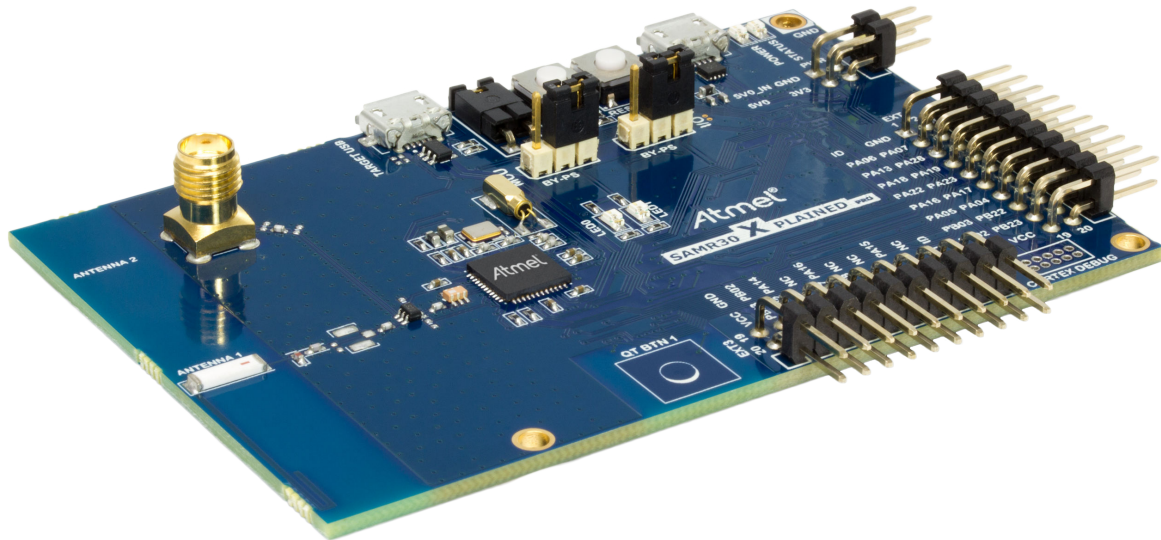

---

**Table of Contents**

---

Description.....	1
1. Introduction.....	4
1.1. Features.....	4
1.2. Kit Overview.....	4
2. Getting Started.....	6
2.1. Xplained Pro Quick Start.....	6
3. Xplained Pro.....	8
3.1. Embedded Debugger.....	8
3.2. Xplained Pro Analog Module (XAM).....	9
3.3. Hardware Identification System.....	11
3.4. Power Sources.....	11
3.5. Xplained Pro Headers and Connectors.....	12
4. Hardware User Guide.....	14
4.1. Power Distribution.....	14
4.2. Connectors.....	14
4.3. Peripherals.....	18
4.4. Embedded Debugger Implementation.....	19
4.5. Kit Modifications.....	22
5. Agency Certification.....	26
5.1. United States (FCC).....	26
5.2. European Union (RED [Radio Equipment Directive]).....	26
5.3. List of Antennas Tested With This Product.....	27
6. Appendix.....	28
6.1. Getting Started with IAR.....	28
6.2. Connecting External Debuggers to an Xplained Pro Board.....	31
7. Hardware Revision History and Known Issues.....	33
7.1. Identifying Product ID and Revision.....	33
7.2. Hardware Revision.....	33
7.3. Known Issues.....	33
8. Document Revision History.....	34
The Microchip Web Site.....	35
Customer Change Notification Service.....	35
Customer Support.....	35
Microchip Devices Code Protection Feature.....	35

Legal Notice.....	36
Trademarks.....	36
Quality Management System Certified by DNV.....	37
Worldwide Sales and Service.....	38

## 1. Introduction

### 1.1 Features

- Kit Supports 868MHz and 915MHz Dual (Wideband) ISM Band
- On-Board Embedded Debugger (EDBG):
  - Auto-ID for board identification in Studio
  - One status LED (yellow)
  - One power supply LED (green)
  - Symbolic debug of complex data types including scope information
  - Programming and debugging including power measurements
  - Data Gateway Interface: Serial Peripheral Interface (SPI) bus, Inter-Integrated Circuit (I<sup>2</sup>C) and four General Purpose Input/Outputs (GPIOs)
  - Virtual COM Port (CDC)
- Embedded Current Measurement Circuitry with [Data Visualizer](#) Support for Data Visualization
- Two Mechanical Buttons (User-Configurable Button and RESET Button)
- Two User LEDs (Soft Orange and Green)
- One QTouch<sup>®</sup> Button
- USB Interface, Device and Reduced Host Mode
- Two Xplained Pro Extension Headers
- Antenna:
  - One ceramic chip antenna (Johanson Technology – 0900AT43A0070)
  - One SMA connector for external antenna
- Three Possible Power Sources:
  - External power
  - Embedded Debugger (EDBG) USB
  - TARGET USB
- Clock Source:
  - 32.768 kHz crystal, a clock source for the controller in the SAM R30 device
  - 16 MHz crystal for the RF die in the SAM R30 device
- Supported with application examples in the Atmel Software Framework

### 1.2 Kit Overview

The SAM R30 device is an ARM-based, ultra low-power microcontroller (MCU) equipped with an IEEE<sup>®</sup> 802.15.4-2003/2006/2011 standard that is compliant with RF interfaces for the sub-1GHz frequency bands, such as 780 MHz (China), 868 MHz (Europe), and 915 MHz (North America). It uses the 32-bit ARM<sup>®</sup> Cortex<sup>®</sup>-M0+ processor, which operates at a maximum of 48 MHz (2.46 CoreMark<sup>®</sup>/MHz) and offers 256KB of Flash and 40KB of SRAM in both 32-pin and 48-pin packages.

The SAM R30 device supports the following power management techniques to reduce current consumption:

- Power Gating
- SleepWalking

- Ultra low-power peripherals, etc.

The kit is designed to work with the ATSAMR30G18A SoC that supports dual ISM band 868 MHz (Europe) and 915 MHz (North America).

**Figure 1-1. SAM R30 Xplained Pro Evaluation Kit**

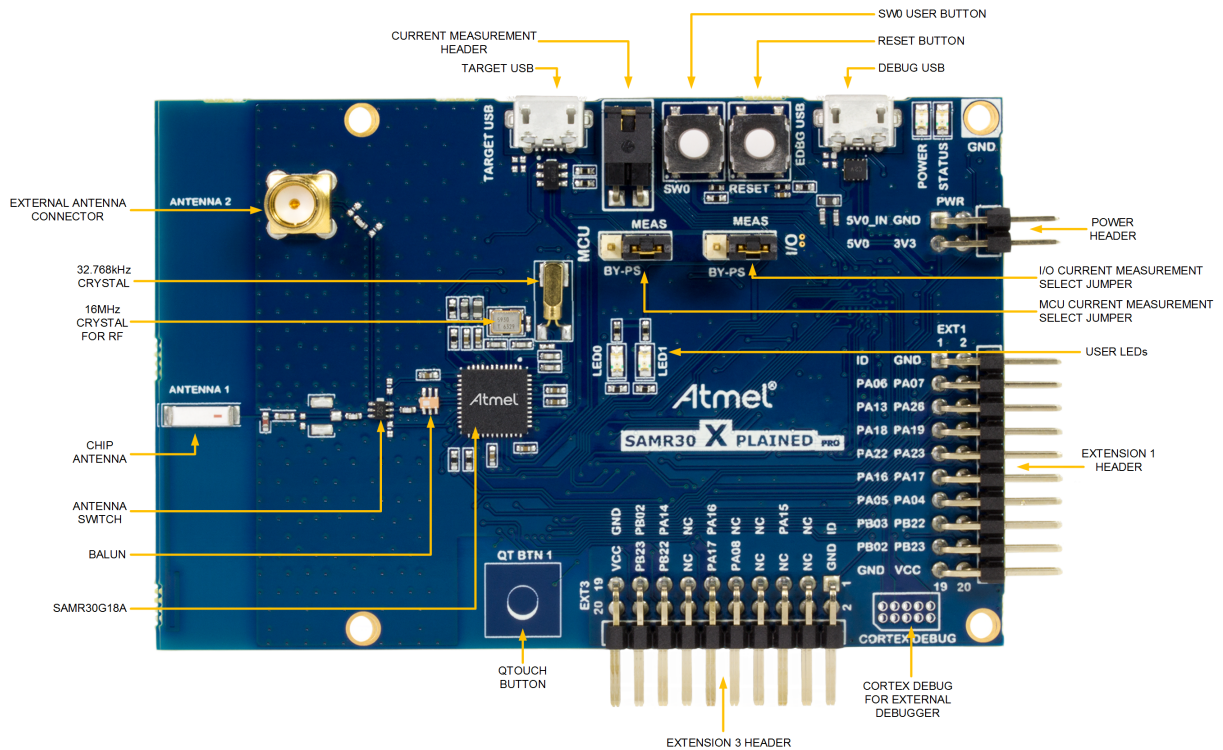

## 2. Getting Started

This chapter describes how to get started with the Xplained Pro evaluation platform and how to find design documentation and other relevant links.

### 2.1 Xplained Pro Quick Start

Steps to start exploring the Xplained Pro platform:

1. Download and install [Atmel Studio](#).
2. Launch Atmel Studio.
3. Connect the DEBUG USB port on the evaluation kit to the computer using a USB cable (Standard-A to Micro-B or Micro-AB).

The operating system installs the driver software automatically the first time the Xplained Pro evaluation kit is connected to a PC. This driver supports 32-bit and 64-bit versions of Microsoft® Windows® XP, Windows Vista®, Windows 7, Windows 8, Windows 10, and Windows Server 2012.

When the Xplained Pro MCU board is powered, the power LED (green) glows and Atmel Studio automatically detects the specific Xplained Pro MCU and extension board(s) that are connected. The kit landing page in Atmel Studio comes with an option to launch Atmel Software Framework (ASF) and Atmel START example application codes for the kit. The SAM R30 device is programmed and debugged by the on-board Embedded Debugger and therefore no external programmer or debugger tool is required.

#### 2.1.1 Design Documentation and Relevant Links

The following list contains links to the most relevant documents and software for the SAM R30 Xplained Pro.

- **Xplained products** - Xplained evaluation kits are a series of easy-to-use evaluation kits for Microchip microcontrollers and other Microchip products.
  - Xplained Nano: used for low pin-count devices and provides a minimalistic solution with access to all I/O pins of the target microcontroller.
  - Xplained Mini: used for medium pin-count devices and adds Arduino Uno compatible header footprint and a prototyping area.
  - Xplained Pro: used for medium to high pin-count devices that features advanced debugging and standardized extensions for peripheral functions.

**Note:** All the above kits have on-board programmers/debuggers, which creates a set of low-cost boards for evaluation and demonstration of features and capabilities of different Microchip products.

- **Atmel Studio** - Free IDE for development of C/C++ and assembler code for microcontrollers.
- **Microchip sample store** - Microchip sample store where you can order samples of devices.
- **EDBG User Guide** - User guide containing more information about the on-board Embedded Debugger.
- **IAR Embedded Workbench® for ARM®** - This is a commercial C/C++ compiler that is available for ARM®. There is a 30 day evaluation version as well as a code size limited kick-start version available from their website. The code size limit is 16KB for devices with M0, M0+, and M1 cores and 32KB for devices with other cores.
- **QTouch® tools** - A collection of tools to design capacitive touch applications.

- **Data Visualizer** - Data Visualizer is a program used for processing and visualizing data. The Data Visualizer can receive data from various sources such as the Embedded Debugger Data Gateway Interface found on Xplained Pro boards and COM Ports.
- **Design Documentation** - Package containing CAD source, schematics, BOM, assembly drawings, 3D plots, layer plots etc.

## 3. Xplained Pro

Xplained Pro is an evaluation platform which contains a series of microcontroller boards (evaluation kits) and extension boards. Atmel Studio is used to program and debug the microcontrollers on these boards. Atmel Studio includes ASF and Atmel START, which has drivers and demo code, and Data Visualizer, which supports data streaming and advanced debugging. Xplained Pro evaluation kits can be connected to a wide range of Xplained Pro extension boards through standardized headers and connectors. Xplained Pro extension boards have identification (ID) chips to uniquely identify which boards are connected to the Xplained Pro evaluation kits.

### 3.1 Embedded Debugger

The SAM R30 Xplained Pro contains an Embedded Debugger (EDBG) for on-board debugging. The EDBG is a USB composite device with the following interfaces:

- Debugger
- Virtual COM Port
- Data Gateway Interface (DGI)

The EDBG can program and debug the ATSAMR30G18A with the help of Atmel Studio. The SWD interface is connected between the EDBG and the ATSAMR30G18A on the SAM R30 Xplained Pro.

The Virtual COM Port is connected to a UART on the ATSAMR30G18A and provides an easy way to communicate with the target application through terminal software. It offers variable baud rate, parity, and stop bit settings. Note that the settings on the ATSAMR30G18A must match the settings given in the terminal software.



**Info:** The Virtual COM Port in the EDBG requires the terminal software to set the Data Terminal Ready (DTR) signal to enable the UART pins connected to the ATSAMR30G18A. If the DTR signal is not enabled, the UART pins on the EDBG are kept in tri-state (high-z) to render the COM Port not usable. The DTR signal is automatically set by some terminal software, but it may have to be manually enabled in your terminal.

---

The DGI consists of several physical interfaces for bidirectional communication with the host computer. Communication over the interfaces is bidirectional. It can be used to send event values, and data from the ATSAMR30G18A. Traffic over the interfaces can be timestamped by the EDBG for more accurate tracing of events, but timestamping reduces the maximal data throughput. The [Data Visualizer](#) is used to send and receive data through DGI.

The EDBG controls two LEDs on the SAM R30 Xplained Pro: a power LED and a status LED. The table below shows how the LEDs are controlled in different operation modes.



**Table 3-1. EDBG LED Control**

Mode	Power LED	Status LED
Normal mode	The power LED is on when power is applied to the board.	Activity indicator, the LED flashes when any communication happens to the EDBG.
Bootloader mode (idle)	The power LED and the status LED blink simultaneously.	
Bootloader mode (firmware upgrade)	The power LED and the status LED blink in an alternating pattern.	

For more details on the EDBG, see the [EDBG User Guide](#).

## 3.2 Xplained Pro Analog Module (XAM)

### 3.2.1 Overview

The Xplained Pro Analog Module (XAM) extends the embedded debugger with high dynamic range current measurement. This enables power profiling of the target system.

**Figure 3-1. XAM Block Diagram**

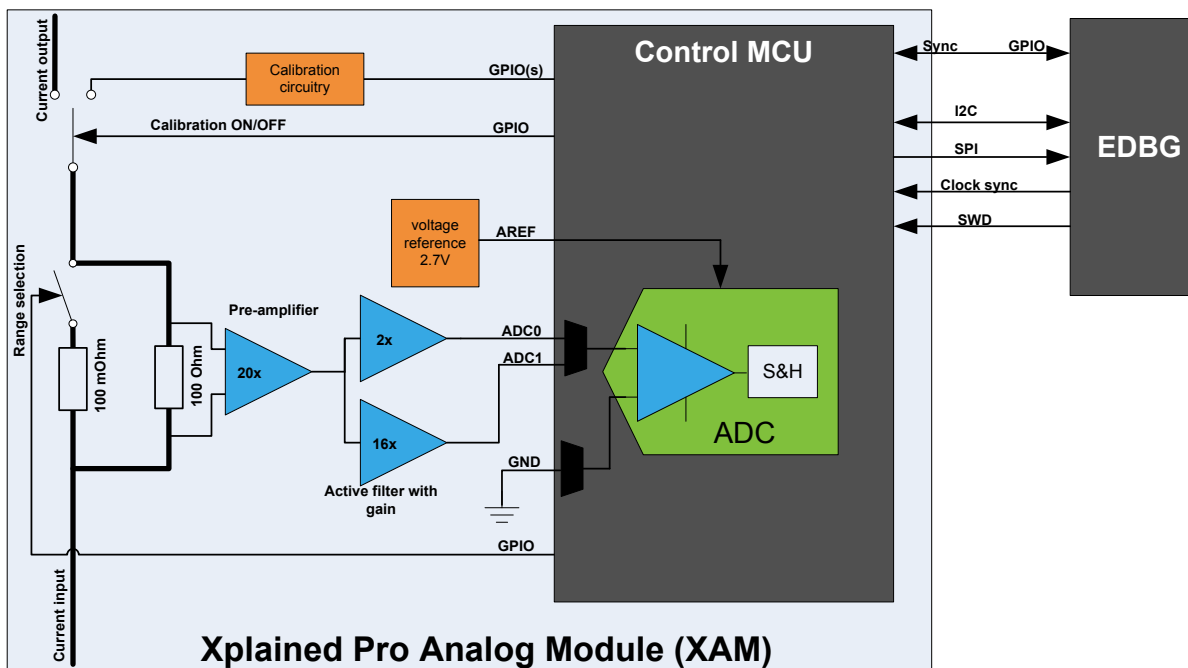

The XAM consists of:

- Calibration circuitry
- Voltage reference circuitry
- Analog front-end:
  - Shunt resistors with a range selection switch
  - Pre-amplifier
  - Two active filters with gain
- Control MCU

- Analog-to-Digital Converter
- Signal processing
- Control/communication interface to the EDBG

The current measurement front-end is a high side shunt measurement with a pre-amplifier and a second active filter stage with gain as shown in [Figure 3-1](#). The wide dynamic range is achieved by four measurement ranges, which are defined by two shunt resistors and the two parallel second stage active filters with gain.

### 3.2.2 EDBG Interface

The XAM is connected to the EDBG with the following interfaces:

- **I<sup>2</sup>C**: This is used to control and configure the XAM.
- **SPI**: Current measurement data is streamed to the EDBG via this interface. This is a unidirectional channel from the XAM to the EDBG.
- **SWD**: The MCU in the XAM is programmed via SWD from the EDBG.
- **Clock sync**: Signal used to synchronize ADC measurements with the EDBG.
- **Reference clock**: Reference clock for the XAM.

### 3.2.3 Sample Rate

The raw sampling rate of the XAM is up to 250 kHz and with the default averaging configuration (average of 16 samples), the actual output of the XAM is 16.67 ksps.



**Info:** The XAM output sample rate is not an integer fraction of the raw sampling.

### 3.2.4 Measurement Ranges and Accuracy

The XAM has four measurement ranges. These are defined by two shunt resistors and two gain stages.

**Table 3-2. XAM Measurement Ranges and Accuracy**

Measurement Range	Hardware	Resolution	Accuracy	Comments
Range 1	Low current shunt and high gain stage	20 nA	1 LSB ±1%	Accuracy will decrease below 1µA. Typical accuracy for 300nA is 1 LSB ± 10%.
Range 2	Low current shunt and low gain stage	150 nA	1 LSB ±1%	
Range 3	High current shunt and high gain stage	10 µA	1 LSB ±1%	
Range 4	High current shunt and low gain stage	100 µA	1 LSB ±1%	Accuracy will decrease above 100 mA. Typical accuracy is 1 LSB ±5% at 400 mA. Maximum current is 400 mA.

The ranges are automatically switched by the XAM to achieve the best measurement results and the currently active range is visualized in the [Data Visualizer](#) front-end tool. The maximum voltage drop over the shunt resistor is 100 mV, and the XAM switches the range automatically before reaching this limit.

### 3.3 Hardware Identification System

All Xplained Pro extension boards come with an identification chip (ATSHA204A CryptoAuthentication chip) to uniquely identify the boards that are connected to the Xplained Pro evaluation kit. This chip contains information that identifies the extension with its name and some extra data. When an Xplained Pro extension is connected to an Xplained Pro evaluation kit, the information is read and sent to Atmel Studio. The following table shows the data fields stored in the ID chip with example content.

**Table 3-3. Xplained Pro ID Chip Content**

Data Field	Data Type	Example Content
Manufacturer	ASCII string	Atmel\0'
Product Name	ASCII string	Segment LCD1 Xplained Pro\0'
Product Revision	ASCII string	02\0'
Product Serial Number	ASCII string	1774020200000010\0'
Minimum Voltage [mV]	uint16_t	3000
Maximum Voltage [mV]	uint16_t	3600
Maximum Current [mA]	uint16_t	30

### 3.4 Power Sources

The SAM R30 Xplained Pro kit can be powered by several power sources, as listed in the table below.

**Table 3-4. Power Sources for SAM R30 Xplained Pro**

Power Source	Voltage Requirements	Current Requirements	Connector Marking
External Power	5V $\pm$ 2% ( $\pm$ 100mV) for USB host operation. 4.3V to 5.5V if a USB host operation is not required.	In USB host applications a minimum of 1A is recommended to supply the kit and the USB device.  Maximum recommended current is 2A.	PWR
Embedded debugger USB	4.4V to 5.25V (according to USB spec.)	500 mA (according to USB spec.)	DEBUG USB
Target USB	4.4V to 5.25V (according to USB spec.)	500 mA (according to USB spec.)	TARGET USB

The kit automatically detects which power sources are available and chooses which one to use according to the following priority:

1. External power.

2. Embedded Debugger USB.
3. Target USB.



**Info:** External power is required when 500mA from a USB connector is not enough to power the board with possible extension boards. A connected USB device in a USB host application might easily exceed this limit.

## 3.5 Xplained Pro Headers and Connectors

### 3.5.1 Xplained Pro Standard Extension Header

All Xplained Pro kits have one or more dual row, 20-pin, 100-mil extension header. The Xplained Pro MCU boards have male headers, while the Xplained Pro extensions have their female counterparts. All connected pins follow the defined pin description in the table.



**Info:** All pins are not always connected on all extension headers.

The extension headers can be used to connect a variety of Xplained Pro extensions to Xplained Pro MCU boards or to access the pins of the target microcontroller on Xplained Pro MCU boards directly.

**Table 3-5. Xplained Pro Standard Extension Header**

Pin Number	Pin Name	Description
1	ID	Pin to communicate with the ID chip on an extension board
2	GND	Ground
3	ADC(+)	Analog-to-Digital Converter; alternatively, a pin for the positive terminal of a differential ADC
4	ADC(-)	Analog-to-Digital Converter; alternatively, a pin for the negative terminal of a differential ADC
5	GPIO1	General purpose I/O pin
6	GPIO2	General purpose I/O pin
7	PWM(+)	Pulse width modulation; alternatively, a pin for the positive part of a differential PWM
8	PWM(-)	Pulse width modulation; alternatively, a pin for the negative part of a differential PWM
9	IRQ/GPIO	Interrupt request pin and/or general purpose I/O pin
10	SPI_SS_B/ GPIO	Slave select pin for Serial Peripheral Interface (SPI) and/or general purpose I/O pin
11	I <sup>2</sup> C_SDA	Data pin for I <sup>2</sup> C interface. Always connected, bus type
12	I <sup>2</sup> C_SCL	Clock pin for I <sup>2</sup> C interface. Always connected, bus type

Pin Number	Pin Name	Description
13	UART_RX	Receiver pin of target device UART
14	UART_TX	Transmitter pin of target device UART
15	SPI_SS_A	Slave select for SPI. This pin should preferably not be connected to anything else.
16	SPI_MOSI	SPI master out slave in pin. Always connected, bus type
17	SPI_MISO	SPI master in slave out pin. Always connected, bus type
18	SPI_SCK	SPI clock pin. Always connected, bus type
19	GND	Ground pin for extension boards
20	VCC	Power pin for extension boards

### 3.5.2 Xplained Pro Power Header

The power header can be used to connect external power to the SAM R30 Xplained Pro kit. The kit automatically detects and switches to any external power if supplied. The power header can also be used to supply power to external peripherals or extension boards. Ensure that the total current does not exceed the recommended current limit of the on-board regulator when using the 3.3V pin.

**Table 3-6. Xplained Pro Power Header**

Pin Number	Pin Name	Description
1	VEXT_P5V0	External 5V input pin
2	GND	Ground pin
3	VCC_P5V0	Unregulated 5V pin (an output, derived from one of the input sources)
4	VCC_P3V3	Regulated 3.3V pin (an output, used as main power supply for the kit)

## 4. Hardware User Guide

### 4.1 Power Distribution

The SAM R30 Xplained Pro can be powered by:

- EDBG USB
- TARGET USB
- External (5V)

The kit has a power mux which automatically chooses the power source if two or all three of the power sources are available to the kit at the same time.

The kit contains:

- Two on-board voltage regulators (3.3V):
  - One for an EDBG and XAM section
  - Another one for ATSAMR30G18A SoC
- IO peripherals
- Power Measurement Section (XAM)

**Figure 4-1. Power Supply Block Diagram**

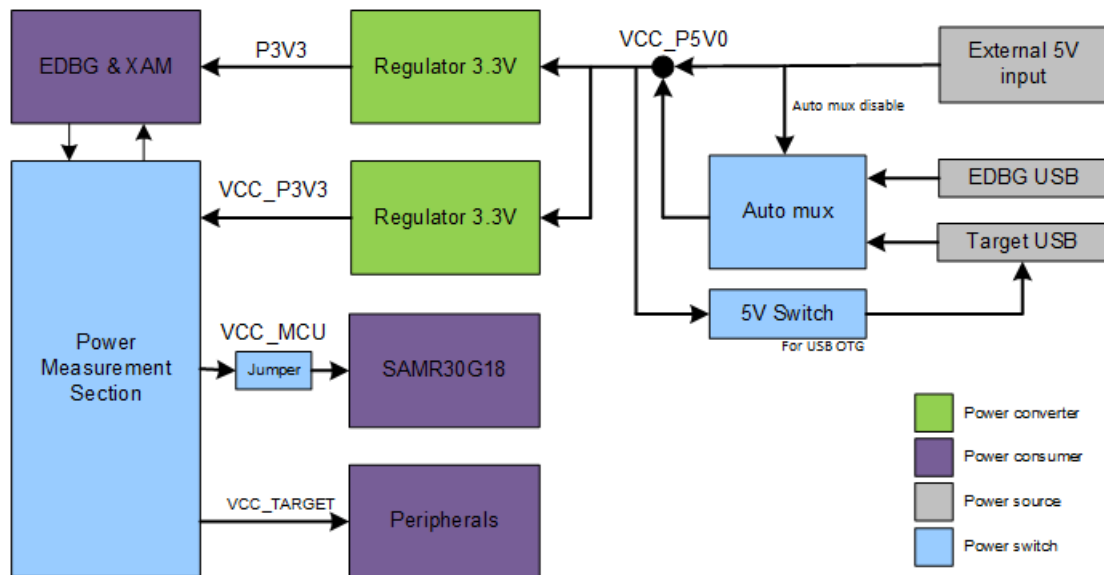

### 4.2 Connectors

The following sections describe the implementation of the relevant connectors and headers on the SAM R30 Xplained Pro and their connection to the ATSAMR30G18A. The following figure shows all the available connectors and jumpers on the SAM R30 Xplained Pro.

**Figure 4-2. SAM R30 Xplained Pro Connector Overview**

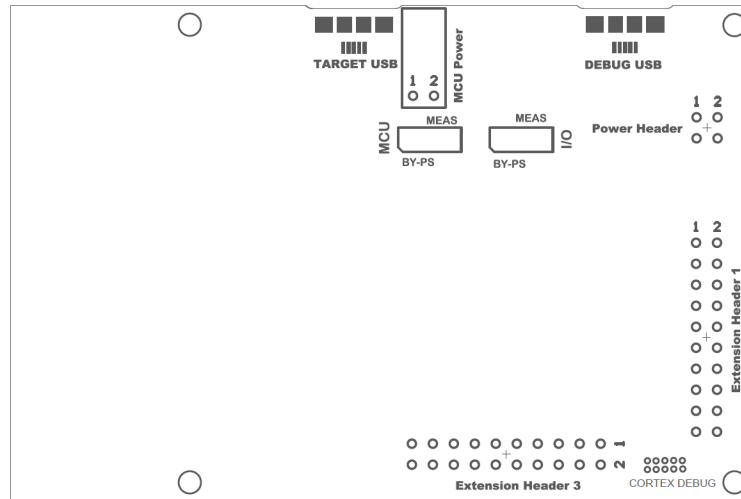

## 4.2.1 Xplained Pro Extension Headers

The SAM R30 Xplained Pro headers EXT1 and EXT3 offer access to the I/O of the MCU in order to expand the board by connecting extensions to the board. These headers are based on the standard extension header specified in the table below. The headers have a pitch of 2.54 mm.

**Table 4-1. Extension Header EXT1**

EXT1 Pin	SAM R30 Pin	Function	Shared Functionality
1 [ID]	-	-	Pin to communicate with the ID chip on an extension board
2 [GND]	-	-	Ground
3 [ADC(+)]	PA06	AIN[6]	
4 [ADC(-)]	PA07	AIN[7]	USB
5 [GPIO1]	PA13	GPIO	
6 [GPIO2]	PA28	GPIO	SW0
7 [PWM(+)]	PA18	TCC0/WO[2]	LED1
8 [PWM(-)]	PA19	TCC0/WO[3]	LED0
9 [IRQ/GPIO]	PA22	EXTINT[6]	
10 [SPI_SS_B/GPIO]	PA23	GPIO	SW0
11 [TWI_SDA]	PA16	SERCOM1 PAD[0] I <sup>2</sup> C SDA	EXT3 and EDBG I <sup>2</sup> C
12 [TWI_SCL]	PA17	SERCOM1 PAD[1] I <sup>2</sup> C SCL	EXT3 and EDBG I <sup>2</sup> C
13 [USART_RX]	PA05	SERCOM0 PAD[1] UART RX	Virtual COM Port
14 [USART_TX]	PA04	SERCOM0 PAD[0] UART TX	Virtual COM Port
15 [SPI_SS_A]	PB03	SERCOM5 PAD[1] SPI SS	
16 [SPI_MOSI]	PB22	SERCOM5 PAD[2] SPI MOSI	EXT3 and EDBG SPI

EXT1 Pin	SAM R30 Pin	Function	Shared Functionality
17 [SPI_MISO]	PB02	SERCOM5 PAD[0] SPI MISO	EXT3 and EDBG SPI
18 [SPI_SCK]	PB23	SERCOM5 PAD[3] SPI SCK	EXT3 and EDBG SPI
19 [GND]	-	-	Ground
20 [VCC]	-	-	Power for extension board

**Table 4-2. Extension Header EXT3**

EXT3 Pin	SAM R30 Pin	Function	Shared Functionality
1 [ID]	-	-	Pin to communicate with the ID chip on an extension board
2 [GND]	-	-	Ground
3 [ADC(+)]	-	-	
4 [ADC(-)]	-	-	
5 [GPIO1]	PA15	GPIO	USB
6 [GPIO2]	-	-	
7 [PWM(+)]	-	-	
8 [PWM(-)]	-	-	
9 [IRQ/GPIO]	-	-	
10 [SPI_SS_B/GPIO]	PA08	GPIO	EDBG DGI GPIO
11 [TWI_SDA]	PA16	SERCOM1 PAD[0] I <sup>2</sup> C SDA	EXT1 and EDBG I <sup>2</sup> C
12 [TWI_SCL]	PA17	SERCOM1 PAD[1] I <sup>2</sup> C SCL	EXT1 and EDBG I <sup>2</sup> C
13 [USART_RX]	-	-	
14 [USART_TX]	-	-	
15 [SPI_SS_A]	PA14	GPIO	EDBG DGI GPIO
16 [SPI_MOSI]	PB22	SERCOM5 PAD[2] SPI MOSI	EXT1 and EDBG SPI
17 [SPI_MISO]	PB02	SERCOM5 PAD[0] SPI MISO	EXT1 and EDBG SPI
18 [SPI_SCK]	PB23	SERCOM5 PAD[3] SPI SCK	EXT1 and EDBG SPI
19 [GND]	-	-	Ground
20 [VCC]	-	-	Power for extension board

## 4.2.2 USB

A Micro-USB is used for connecting the SAM R30 board (TARGET USB port) with a host PC. To be able to detect when a TARGET USB cable is connected in self-powered mode, a GPIO is used to detect the VBUS voltage on the connector. In USB host mode, VBUS voltage is provided by the kit and cannot identify the connected device, so another GPIO is used to detect the USB ID of the device.



**Table 4-3. USB Connections**

SAM R30 Pin	USB Function	Shared Functionality
PA07	VBUS Detection	<a href="#">EXT1</a>
PA15	USB ID	<a href="#">EXT3</a>
PA24	USB D-	-
PA25	USB D+	-

### 4.2.3 Current Measurement Header

An angled 1x2, 100-mil pin header marked with the MCU current measurement is located at the upper edge of the SAM R30 Xplained Pro. All power to the ATSAMR30G18A is exclusively routed through this header (excluding power to headers and peripherals). To measure the power consumption of the device, remove the jumper and replace it with an ammeter.



**Caution:** Removing the jumper from the pin header while the kit is powered may cause the ATSAMR30G18A to be powered through its I/O pins. This may cause permanent damage to the device.

### 4.2.4 Cortex Debug Connector

The SAM R30 Xplained Pro contains a 10-pin 50-mil Cortex<sup>®</sup> Debug Connector that can be used to attach an external debugger to the ATSAMR30G18A SoC.

**Table 4-4. Cortex Debug Connector**

Cortex Debug Connector Pin	Pin / Net	Function	Shared Functionality
1	VCC_TARGET_P3V3	ATSAMR30G18A voltage	
2	PA31	SWD data signal	<a href="#">EDBG SWD</a>
3	GND	Ground	
4	PA30	SWD clock signal	<a href="#">EDBG SWD</a>
5	GND	Ground	
6	-	-	
7	-	-	
8	-	-	
9	GND	Ground	
10	RESETN	Target reset signal	

## 4.3 Peripherals

### 4.3.1 Crystal

The SAM R30 Xplained Pro kit contains a 32.768 kHz crystal that can be used as a clock source for the SAM R30 device. A cut-strap next to the crystal is used to measure the oscillator safety factor. This is done by cutting the strap and adding a resistor across the strap. More information about oscillator allowance and safety factor can be found in the [AVR4100](#) application note from Microchip.



**Info:** The 16 MHz crystal is connected directly to the RF die inside the SAM R30. The clock signal generated by this crystal is routed from the CLKM pin on the RF die to a GCLK I/O pin on the microcontroller. For more information on how the RF die is connected to the microcontroller and how to configure the CLKM pin, see the [SAM R30 datasheet](#).

**Table 4-5. External 32.768 kHz Crystal**

Pin on SAM R30	Function
PA00	XIN32
PA01	XOUT32

**Table 4-6. External 16 MHz Crystal**

Pin on SAM R30	Function
XTAL1	XIN
XTAL2	XOUT

### 4.3.2 Mechanical Buttons

The SAM R30 Xplained Pro contains two mechanical buttons.

- The RESET button is connected to the SAM R30 reset line:
  - When the RESET button is pressed, it drives the reset line to ground
- Generic user configurable button:
  - When the user button is pressed, it drives the I/O line to ground



**note:** There is no pull-up resistor connected to the generic user button. Remember to enable the internal pull-up in the SAM R30 to use the button.

**Table 4-7. Mechanical Buttons**

SAM R30 Pin	Silkscreen Text	Shared Functionality
RESET	RESET	-
PA28	SW0	<a href="#">EXT1</a>

### 4.3.3 LEDs

The SAM R30 Xplained Pro board contain two LEDs. The LEDs can be activated by driving the connected I/O line to ground (GND).

**Table 4-8. LED Connections**

SAM R30 Pin	Function	Shared Functionality
PA19	LED0 (Color: Soft Orange)	<a href="#">EXT3</a>
PA18	LED1 (Color: Green)	<a href="#">EXT3</a>

#### 4.3.4 QTouch Button

The SAM R30 Xplained Pro board contains a self capacitance button, which can be used as an I/O. This QTouch button is intended to be driven by the built-in Peripheral Touch Controller (PTC) of the device. A zero ohm resistor is added on the board to easily disconnect the on-board touch buttons from the extension header since the I/O lines are shared between the QTouch button and extension header 1 (EXT1).



**note:** To get started with QTouch, refer to the [QTouch® Library](#) and [QTouch® Composer](#).

**Table 4-9. QTouch Connection**

SAM R30 Pin	Silkscreen Text	Shared Functionality
PA06	QT BTN1	<a href="#">EXT1</a>

#### 4.3.5 RF

The main feature of the SAM R30 Xplained Pro is to show the RF capability of the ATSAMR30G18A SoC. This device has bidirectional 100 ohm differential antenna pins, which are fed through a balun (Johanson Technology, [0896BM15A0032](#)) to create a single 50 ohm unbalanced output/input. This kit has a passive analog RF switch (Skyworks Solutions Inc, [AS222-92LF](#)) connected to the unbalanced output of the balun. The switch is driven by the RFCTRL1 and RFCTRL2 pins of the ATSAMR30G18A, which feature Antenna Diversity to enable the device to automatically select the best signal from the two antennas (can also be selected manually). The output of the switch is connected to a ceramic chip antenna (Johanson Technology, [0900AT43A0070](#)) and an SMA connector for external antennas.

**Table 4-10. RF Connections**

SAM R30Pin	RF	Shared Functionality
RFP	RF balanced output (positive)	
RFN	RF balanced output (negative)	
PA09/RFCTRL1	RF switch control signal (negative)	<a href="#">EDBG DGI GPIO</a>
PA12/RFCTRL2	RF switch control signal (positive)	<a href="#">EDBG DGI GPIO</a>

## 4.4 Embedded Debugger Implementation

The SAM R30 Xplained Pro contains an Embedded Debugger (EDBG) that can be used to program and debug the ATSAMR30G18A SoC using Serial Wire Debug (SWD). The Embedded Debugger includes a Virtual COM Port interface over UART, Data Gateway Interface over SPI, I<sup>2</sup>C and four GPIOs. The kit also includes an XAM extension processor to the Embedded Debugger for on-board current measurement. Atmel Studio can be used as a front-end for the Embedded Debugger.

## 4.4.1 Serial Wire Debug

The Serial Wire Debug (SWD) uses two pins to communicate with the target. For further information on how to use the programming and debugging capabilities of the EDBG, refer to [Embedded Debugger](#).

**Table 4-11. SWD Connections**

SAM R30 Pin	Function	Shared Functionality
PA30	SWD clock	<a href="#">Cortex debug connector</a>
PA31	SWD data	<a href="#">Cortex debug connector</a>

## 4.4.2 Virtual COM Port

The Embedded Debugger acts as a Virtual COM Port gateway by using one of the ATSAMR30G18A UARTs. For further information on how to use the Virtual COM Port, refer to [Embedded Debugger](#).

**Table 4-12. Virtual COM Port Connections**

SAM R30 pin	Function	Shared functionality
PA04	SERCOM0 PAD[0] UART TXD (SAM R30 TX line)	<a href="#">EXT1</a>
PA05	SERCOM0 PAD[1] UART RXD (SAM R30 RX line)	<a href="#">EXT1</a>

## 4.4.3 Data Gateway Interface

The Embedded Debugger features a Data Gateway Interface (DGI) by using either an SPI or I<sup>2</sup>C. The DGI can be used for sending data from the ATSAMR30G18A to the host PC. For further information on how to use the DGI interface, refer to the [Data Visualizer](#) and the [EDBG User Guide](#).

**Table 4-13. DGI Interface Connections When Using SPI**

SAM R30 Pin	Function	Shared Functionality
PA27	GPIO/SPI SS (Slave Select) (SAM R30 is Master)	-
PB02	SERCOM5 PAD[0] SPI MISO (Master In, Slave Out)	<a href="#">EXT1</a> and <a href="#">EXT3</a>
PB22	SERCOM5 PAD[2] SPI MOSI (Master Out, Slave in)	<a href="#">EXT1</a> and <a href="#">EXT3</a>
PB23	SERCOM5 PAD[3] SPI SCK (Clock Out)	<a href="#">EXT1</a> and <a href="#">EXT3</a>

**Table 4-14. DGI Interface Connections When Using I<sup>2</sup>C**

SAM R30 Pin	Function	Shared Functionality
PA16	SERCOM1 PAD[0] SDA (Data line)	<a href="#">EXT1</a> and <a href="#">EXT3</a>
PA17	SERCOM1 PAD[1] SCL (Clock line)	<a href="#">EXT1</a> and <a href="#">EXT3</a>

Four GPIO lines are connected to the Embedded Debugger. The EDBG can monitor these lines and time stamp pin value changes. This makes it possible to accurately timestamp events in the SAM R30 application code. For further information on how to configure and use the GPIO monitoring features, refer to the [Data Visualizer](#) and the [EDBG User Guide](#).

**Table 4-15. GPIO Lines Connected to the EDBG**

SAM R30 Pin	Function	Shared Functionality
PA08	GPIO0	EXT3
PA09	GPIO1	RFCTRL
PA12	GPIO2	RFCTRL
PA14	GPIO3	EXT3

**4.4.4 XAM Configuration**

On the SAM R30 Xplained Pro, the MCU and MCU peripherals are powered by its own regulator as shown in Figure 4-3. All other parts of the board, mainly the embedded debugger and Xplained Pro Analog Module (XAM), are powered by a separate regulator. The current consumed by the MCU and the peripherals can be measured by connecting them to the XAM output through jumper settings.

**Figure 4-3. SAM R30 Xplained Pro XAM Implementation Block Diagram**

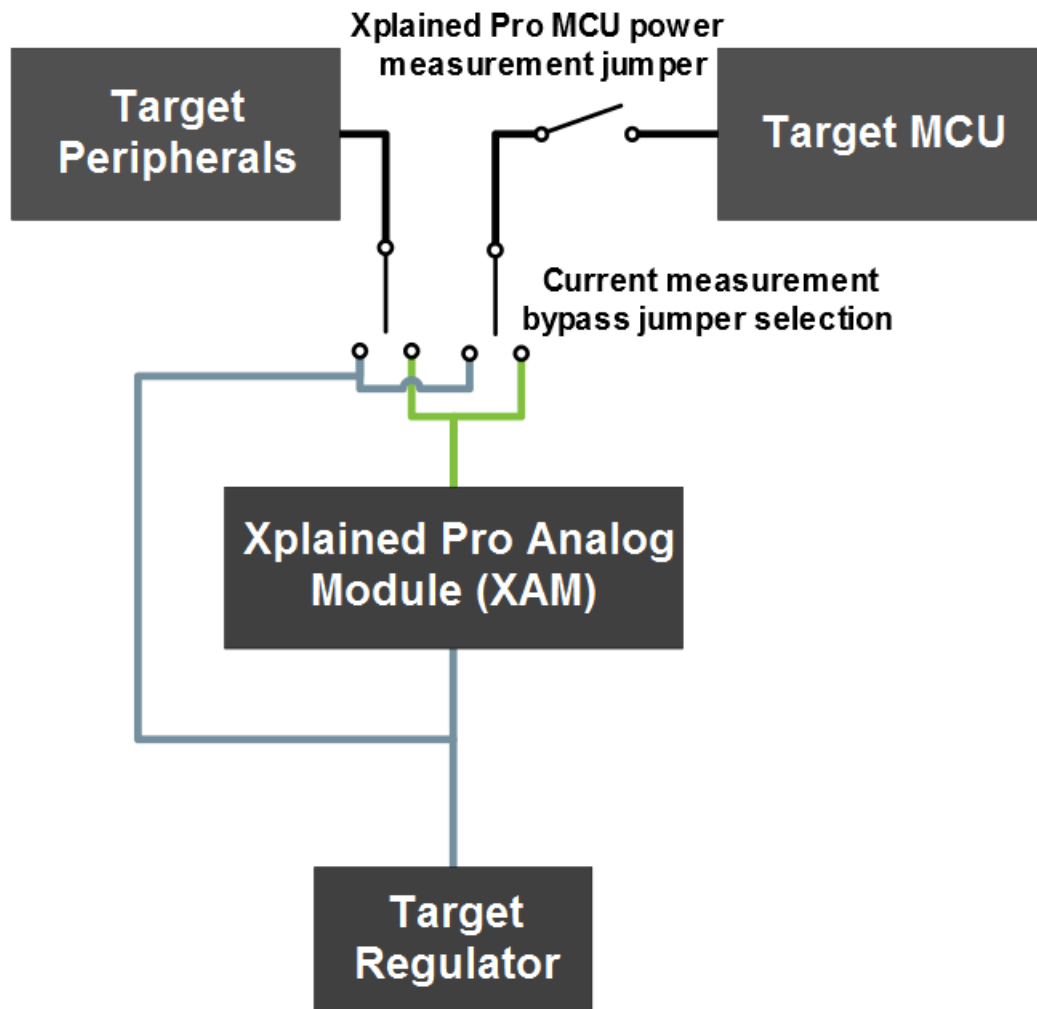

The XAM can be used in any of the following configurations:

1. **No current measurement or an external MCU current measurement:** The XAM is bypassed, thus the MCU and peripherals are supplied directly by the regulator. Set both jumpers (MCU and I/O) in the "BY-PS(BYPASS)" position. In this configuration, it is also possible to connect an external measurement tool with the Xplained Pro MCU power measurement header to measure MCU current directly instead of using the XAM.
2. **MCU current measurement:** The XAM measures only the MCU current while the peripherals are supplied directly by the regulator. For this configuration, place the jumper for "I/O" (peripherals) into the "BY-PS(BYPASS)" position and the "MCU" into the "MEAS (MEASURE)" position.
3. **Peripherals measurement:** The XAM measures only the peripherals current while the MCU is directly supplied by the regulator. For this configuration, place the jumper for "MCU" into the "BY-PS(BYPASS)" position and the "I/O" jumper into the "MEAS (MEASURE)" position.
4. **MCU and peripherals measurement:** In this configuration, both the MCU and peripherals are measured by the XAM. Place both jumpers on the "I/O" and "MCU" headers in the "MEAS (MEASURE)" position.

## 4.5 Kit Modifications

The SAM R30 Xplained Pro contains several resistors that can be used to disconnect I/O pins of the ATSAMR30G18A SoC from connectors and on-board ICs, and to disconnect power signals.

**Table 4-16. Zero Ohm Resistors**

Designator	Value	From	To	Comment
R322	0R	EDBG SWDIO	PA31 SWDIO	Debug interface from the EDBG to the ATSAMR30G18A
R323	0R	EDBG SWDCLK	PA30 SWCLK	
R324	0R	EDBG TARGET RESET	TARGET MCU RESET	
R310	0R	EDBG SPI SS	PA27 GPIO	EDBG CDC and DGI interfaces to the ATSAMR30G18A
R311	0R	EDBG SPI SCK	PB23 SPI SCK	
R312	0R	EDBG SPI MOSI	PB22 SPI MOSI	
R313	0R	EDBG SPI MISO	PB02 SPI MISO	
R314	0R	EDBG DGI SDA	PA16 I2C SDA	
R315	0R	EDBG DGI SCL	PA17 I2C SCL	
R316	0R	EDBG CDC RX	PA04 UART TX	
R317	0R	EDBG CDC TX	PA05 UART RX	
R318	0R	EDBG DGI_GPIO0	PA08 GPIO	
R319	0R	EDBG DGI_GPIO1	PA09 GPIO	
R320	0R	EDBG DGI_GPIO2	PA12 GPIO	
R321	0R	EDBG DGI_GPIO3	PA14 GPIO	



pins marked 3V3 (pin 4) and GND (pin 2) on the Xplained Pro power header. To program and debug the ATSAMR30G18A, the 2x5 50-mil Cortex debug connector must be used with an external debugger.



**Info:** Operating the ATSAMR30G18A SoC at voltages other than 3.3V requires physical modifications on the kit using a soldering iron and an external debugger for programming the ATSAMR30G18A SoC. The on-board current measurement only works at 3.3V. The on-board LED is selected for 3.3V operation; the LED brightness at 1.8V operation is dull. To increase the emitted light level, the value of the series resistor can be lowered. EDBG functionality can be restored by re-soldering the removed components.



**Caution:** The voltage supplied through the power header is applied directly to the ATSAMR30G18A SoC and the extension headers. Applying a voltage greater than 3.3V may damage the board permanently.

**Figure 4-5. SAM R30 Xplained Pro EDBG Disconnect**

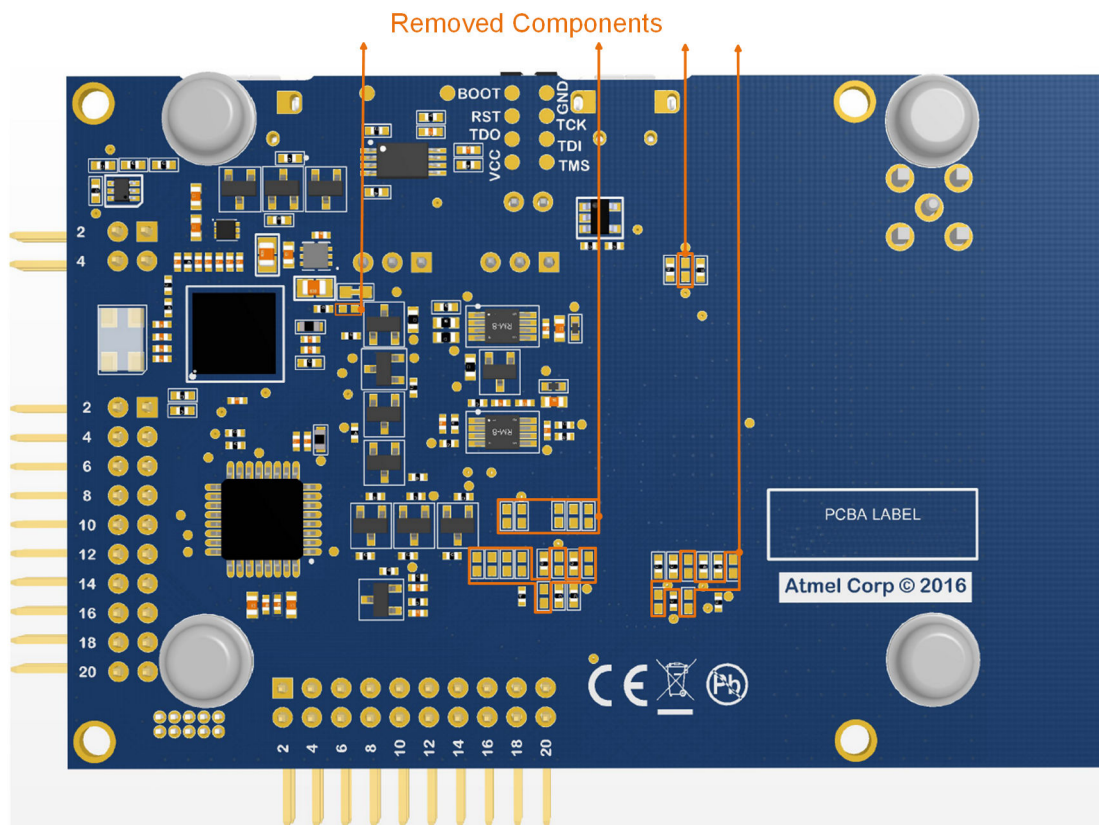
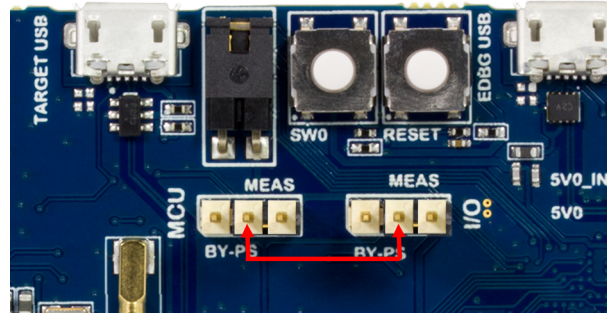



Figure 4-6. SAM R30 Xplained Pro Current Measurement Headers



### Related Links

[Xplained Pro Power Header](#)

[Cortex Debug Connector](#)

[Connectors](#)

## 5. Agency Certification

### 5.1 United States (FCC)

This equipment (SAM R30 Xplained Pro) is for evaluation purposes only and must not be incorporated into any other device or system.



**Important:**  
**Contains FCC ID:VW4A092722**

**These devices comply with part 15 of the FCC Rules.**

Operation is subject to the following two conditions:

- (1) These devices may not cause harmful interference, and
  - (2) These devices must accept any interference received, including interference that may cause undesired operation (FCC 15.19).
- 

The internal / external antenna(s) used for this mobile transmitter must provide a separation distance of at least 20 cm from all persons and must not be co-located or operating in conjunction with any other antenna or transmitter.

Installers must be provided with antenna installation instructions and transmitter operating conditions for satisfying RF exposure compliance. This device is approved as a mobile device with respect to RF exposure compliance, and may only be marketed to OEM installers. Use in portable exposure conditions (FCC 2.1093) requires separate equipment authorization.



**Important:**  
Changes or modifications not expressly approved by this company for compliance could void the user's authority to operate this equipment (FCC section 15.21).

---



**Important:**  
This equipment has been tested and found to comply with the limits for a Class A digital device, pursuant to Part 15 of the FCC Rules. These limits are designed to provide reasonable protection against harmful interference when the equipment is operated in a commercial environment. This equipment generates, uses, and can radiate radio frequency energy and, if not installed and used in accordance with the instructions, may cause harmful interference to radio communications. Operation of this equipment in a residential area is likely to cause harmful interference in which case the user must correct the interference at his own expense (FCC section 15.105).

---

### 5.2 European Union (RED [Radio Equipment Directive])

The SAM R30 Xplained Pro evaluation kit has been certified for use in European Union countries. A Declaration of Conformity must be issued for each of these standards and kept on file as described in Radio Equipment Directive.

Furthermore, the manufacturer must maintain a copy of the module's documentation and ensure the final product does not exceed the specified power ratings, antenna specifications, and/or installation requirements as specified in the user manual. If any of these specifications are exceeded in the final product, a submission must be made to a notified body for compliance testing to all required standards.



**Important:**

On account of the nature of radio equipment, the height of the CE marking affixed to radio equipment may be lower than 5 mm, provided that it remains visible and legible.

More detailed information about CE marking requirements, refer [Article 19](#) of "DIRECTIVE 2014/53/EU OF THE EUROPEAN PARLIAMENT AND OF THE COUNCIL" of 16 April 2014.

## 5.3 List of Antennas Tested With This Product

**Table 5-1. List of Tested Antennas**

Antenna number	Make	Model/part #	Peak gain [dBi]	Type of antenna
Antenna 1	Johanson Technology	<a href="#">0900AT43A0070</a>	-0.5dBi(typ.)	Ceramic Chip Antenna
Antenna 2	CompoTEK GmbH	<a href="#">CTA 868/0/WS/SM/H1</a>	0 dBi	External SMA Antenna

## 6. Appendix

### 6.1 Getting Started with IAR

IAR Embedded Workbench® for ARM® is a proprietary, high-efficiency compiler not based on GCC. The programming and debugging of Xplained Pro kits are supported in IAR™ Embedded Workbench for ARM using the common CMSIS-DAP interface. Some initial settings have to be set up in the project to get programming and debugging to work.

The following steps explain how to set up a project for programming and debugging:

1. Open the project that needs to be configured. Open the **OPTIONS** dialog for the project.
2. In the **General Options** category, select the **Target** tab. [Select the "Device" for the project or the "Core" of the device.](#)
3. In the **Debugger** category, select the **Setup** tab. [Select CMSIS DAP as the driver.](#)
4. In the **Debugger** category, select the **Download** tab. [Select the Use flash loader\(s\) option.](#)
5. In the **Debugger > CMSIS DAP** category, select the **Setup** tab. [Select System \(default\) as the reset method.](#)
6. In the category **Debugger > CMSIS DAP**, select the **JTAG/SWD** tab. [Select SWD as the interface and optionally select the SWD speed.](#)

**Figure 6-1. Select Target Device**

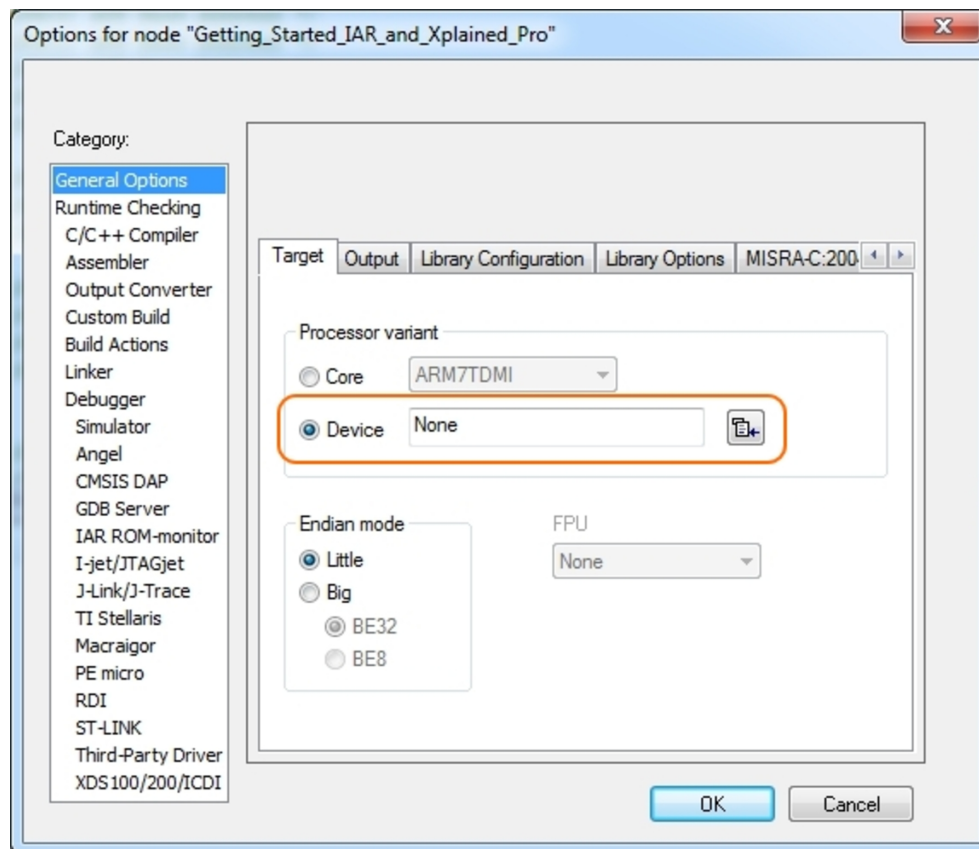

Figure 6-2. Select Debugger

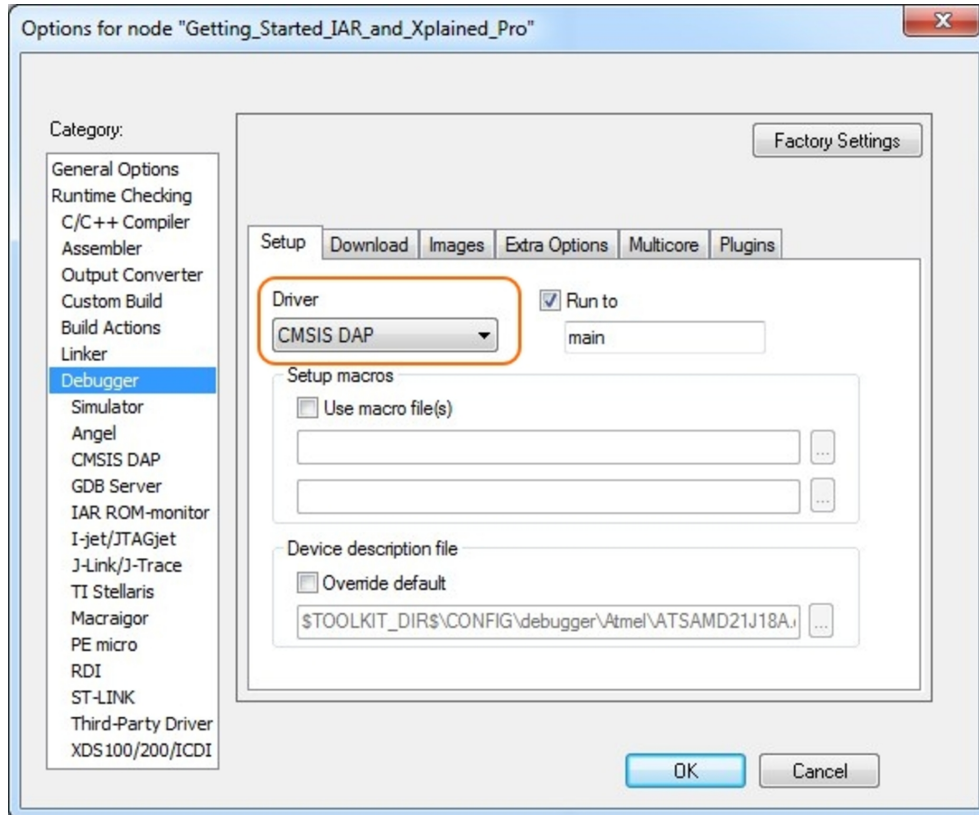

Figure 6-3. Configure Flash Loader

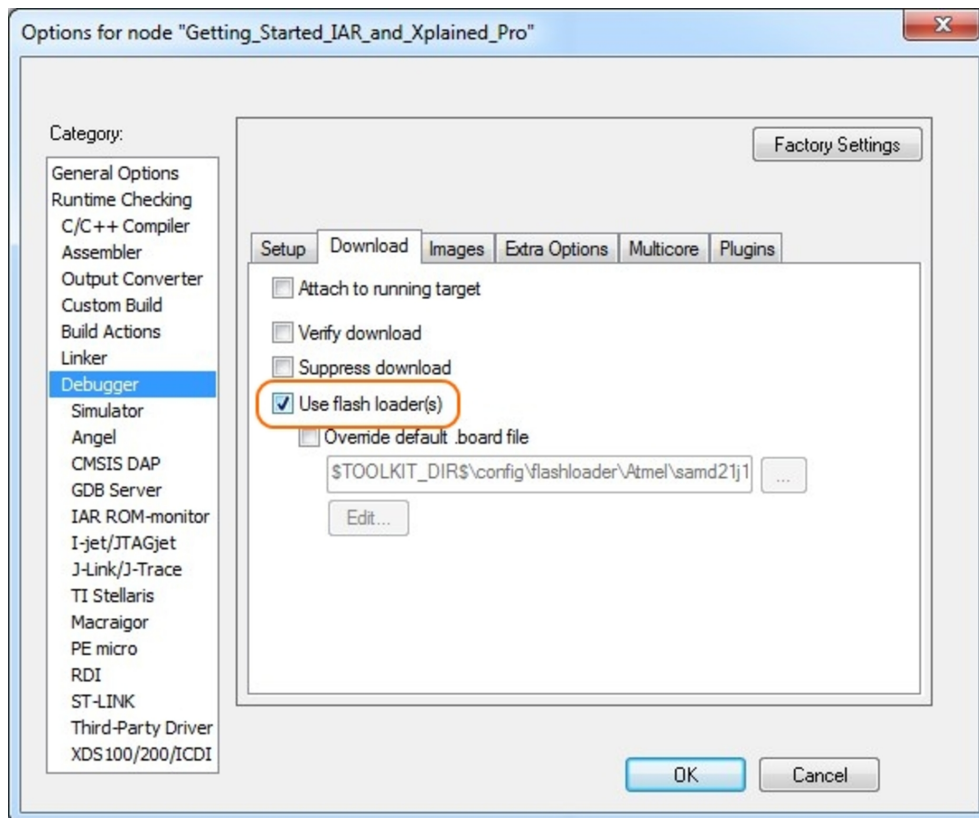

Figure 6-4. Configure Reset

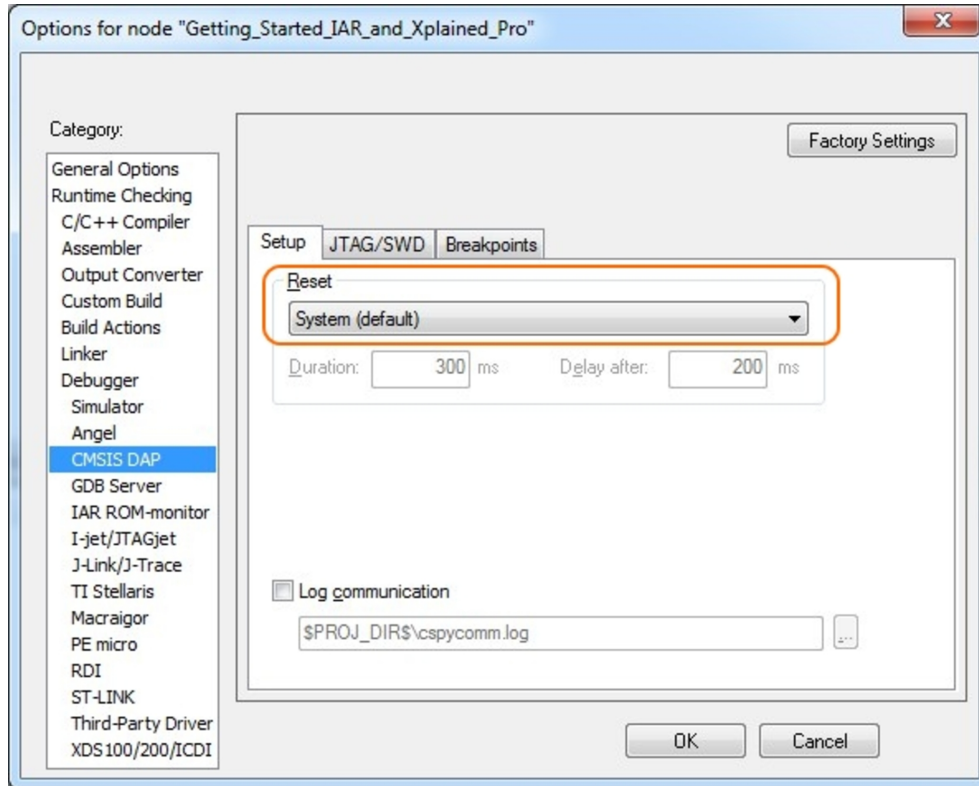
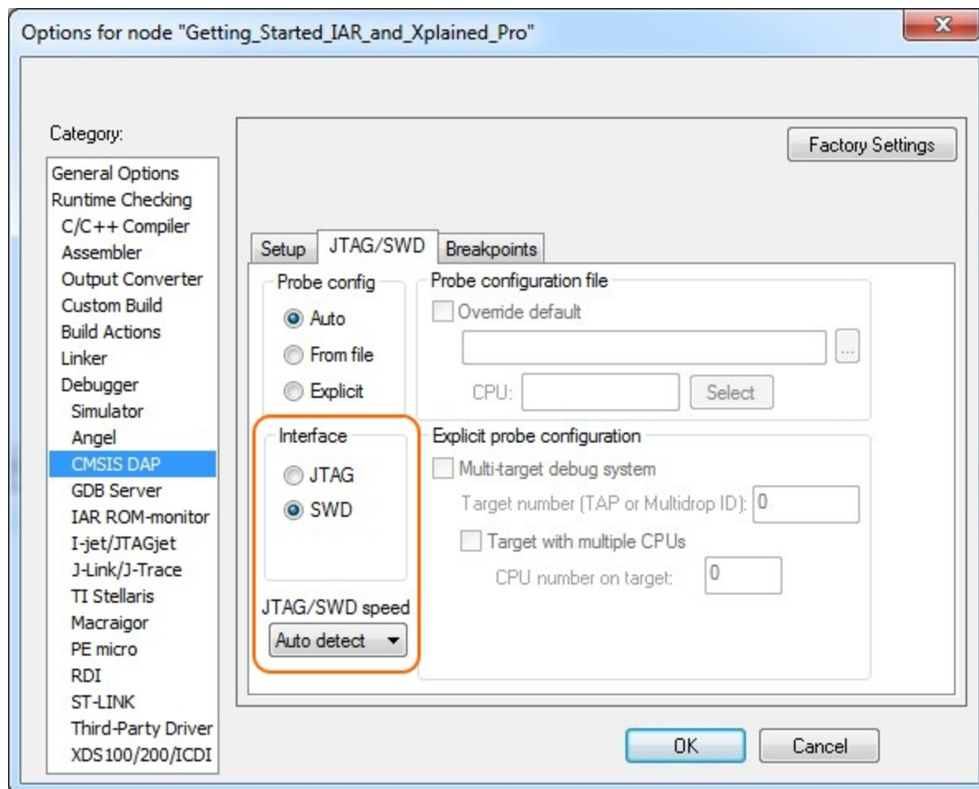

Figure 6-5. Configure Interface



## 6.2 Connecting External Debuggers to an Xplained Pro Board

The Xplained Pro kits that features a 10-pin 50mil debug connector can use external debug tools like SAM-ICE™ or Atmel-ICE instead of the built-in EDBG. Evaluation kits with devices using the SWD interface on-board has a connector that is pinout compatible with the [Cortex Debug Connector](#).

The SAM-ICE is connected to the debug connector on an Xplained Pro using either an Atmel-ICE adapter, SAM-ICE adapter, or a 10-pin 50-mil header to squid cable. When using a squid cable, see the table and figures below for how to connect the SAM-ICE to the Xplained Pro board.

**Table 6-1. Squid Cable Connections**

Squid Cable Pin	SAM-ICE Pin
1 (VCC)	1 (VTref)
2 (SWDIO/TMS)	7 (TMS)
3 (GND)	4 (GND)
4 (SWCLK/TCK)	9 (TCK)
5 (GND)	6 (GND)
6 (SWO/TDO)	13 (TDO) <sup>(1)</sup>
7 (Not used)	
8 (Not used)	
9 (Not used)	
10 (RESET)	15 (RESET)

**Note:**

1. Optional pin; used only when the device functionality supports TDO.

**Figure 6-6. SAM-ICE using a Squid Cable**



Figure 6-7. SAM-ICE using an Atmel-ICE Adapter



**Important:**

If contention with the on-board EDBG occurs, power the Xplained Pro board from another input like the external power header or from the target USB. Physically removing the connection between the EDBG and the debug header by removing 0Ω resistors, where available, or cutting the tracks to the EDBG can also be done.



## **7. Hardware Revision History and Known Issues**

### **7.1 Identifying Product ID and Revision**

The revision and product identifier of the Xplained Pro boards can be found in two ways: either through Atmel Studio or by looking at the sticker on the bottom side of the PCB.

When an Xplained Pro MCU board is connected to a computer with Atmel Studio running, an information window with the serial number is shown. The first six digits of the serial number contain the product identifier and revision. Information about connected Xplained Pro extension boards is also shown in the window.

The same information can be found on the sticker on the bottom side of the PCB. Most kits have stickers that have the identifier and revision printed in plain text as A09-nnnn\rr, where nnnn is the identifier and rr is the revision. Boards with limited space have a sticker with only a data matrix code, which contains a serial number string.

The serial number string has the following format:

```
"nnnnrrssssssss"  
n = product identifier  
r = revision  
s = serial number
```

The product identifier for the SAM R30 Xplained Pro is A09-2722.

### **7.2 Hardware Revision**

Revision 7 of the SAM R30 Xplained Pro is the initial released version to the market.

### **7.3 Known Issues**

No known issues.

## 8. Document Revision History

Revision A - 04/2017

Section	Changes
Document	Initial Release

## The Microchip Web Site

---

Microchip provides online support via our web site at <http://www.microchip.com/>. This web site is used as a means to make files and information easily available to customers. Accessible by using your favorite Internet browser, the web site contains the following information:

- **Product Support** – Data sheets and errata, application notes and sample programs, design resources, user's guides and hardware support documents, latest software releases and archived software
- **General Technical Support** – Frequently Asked Questions (FAQ), technical support requests, online discussion groups, Microchip consultant program member listing
- **Business of Microchip** – Product selector and ordering guides, latest Microchip press releases, listing of seminars and events, listings of Microchip sales offices, distributors and factory representatives

## Customer Change Notification Service

---

Microchip's customer notification service helps keep customers current on Microchip products. Subscribers will receive e-mail notification whenever there are changes, updates, revisions or errata related to a specified product family or development tool of interest.

To register, access the Microchip web site at <http://www.microchip.com/>. Under "Support", click on "Customer Change Notification" and follow the registration instructions.

## Customer Support

---

Users of Microchip products can receive assistance through several channels:

- Distributor or Representative
- Local Sales Office
- Field Application Engineer (FAE)
- Technical Support

Customers should contact their distributor, representative or Field Application Engineer (FAE) for support. Local sales offices are also available to help customers. A listing of sales offices and locations is included in the back of this document.

Technical support is available through the web site at: <http://www.microchip.com/support>

## Microchip Devices Code Protection Feature

---

Note the following details of the code protection feature on Microchip devices:

- Microchip products meet the specification contained in their particular Microchip Data Sheet.
- Microchip believes that its family of products is one of the most secure families of its kind on the market today, when used in the intended manner and under normal conditions.
- There are dishonest and possibly illegal methods used to breach the code protection feature. All of these methods, to our knowledge, require using the Microchip products in a manner outside the operating specifications contained in Microchip's Data Sheets. Most likely, the person doing so is engaged in theft of intellectual property.
- Microchip is willing to work with the customer who is concerned about the integrity of their code.

- Neither Microchip nor any other semiconductor manufacturer can guarantee the security of their code. Code protection does not mean that we are guaranteeing the product as “unbreakable.”

Code protection is constantly evolving. We at Microchip are committed to continuously improving the code protection features of our products. Attempts to break Microchip’s code protection feature may be a violation of the Digital Millennium Copyright Act. If such acts allow unauthorized access to your software or other copyrighted work, you may have a right to sue for relief under that Act.

## Legal Notice

---

Information contained in this publication regarding device applications and the like is provided only for your convenience and may be superseded by updates. It is your responsibility to ensure that your application meets with your specifications. MICROCHIP MAKES NO REPRESENTATIONS OR WARRANTIES OF ANY KIND WHETHER EXPRESS OR IMPLIED, WRITTEN OR ORAL, STATUTORY OR OTHERWISE, RELATED TO THE INFORMATION, INCLUDING BUT NOT LIMITED TO ITS CONDITION, QUALITY, PERFORMANCE, MERCHANTABILITY OR FITNESS FOR PURPOSE. Microchip disclaims all liability arising from this information and its use. Use of Microchip devices in life support and/or safety applications is entirely at the buyer’s risk, and the buyer agrees to defend, indemnify and hold harmless Microchip from any and all damages, claims, suits, or expenses resulting from such use. No licenses are conveyed, implicitly or otherwise, under any Microchip intellectual property rights unless otherwise stated.

## Trademarks

---

The Microchip name and logo, the Microchip logo, AnyRate, AVR, AVR logo, AVR Freaks, BeaconThings, BitCloud, CryptoMemory, CryptoRF, dsPIC, FlashFlex, flexPWR, Heldo, JukeBlox, KeeLoq, KeeLoq logo, Klear, LANCheck, LINK MD, maXStylus, maXTouch, MediaLB, megaAVR, MOST, MOST logo, MPLAB, OptoLyzer, PIC, picoPower, PICSTART, PIC32 logo, Prochip Designer, QTouch, RightTouch, SAM-BA, SpyNIC, SST, SST Logo, SuperFlash, tinyAVR, UNI/O, and XMEGA are registered trademarks of Microchip Technology Incorporated in the U.S.A. and other countries.

ClockWorks, The Embedded Control Solutions Company, EtherSynch, Hyper Speed Control, HyperLight Load, IntelliMOS, mTouch, Precision Edge, and Quiet-Wire are registered trademarks of Microchip Technology Incorporated in the U.S.A.

Adjacent Key Suppression, AKS, Analog-for-the-Digital Age, Any Capacitor, AnyIn, AnyOut, BodyCom, chipKIT, chipKIT logo, CodeGuard, CryptoAuthentication, CryptoCompanion, CryptoController, dsPICDEM, dsPICDEM.net, Dynamic Average Matching, DAM, ECAN, EtherGREEN, In-Circuit Serial Programming, ICSP, Inter-Chip Connectivity, JitterBlocker, KlearNet, KlearNet logo, Mindi, MiWi, motorBench, MPASM, MPF, MPLAB Certified logo, MPLIB, MPLINK, MultiTRAK, NetDetach, Omniscient Code Generation, PICDEM, PICDEM.net, PICTail, PureSilicon, QMatrix, RightTouch logo, REAL ICE, Ripple Blocker, SAM-ICE, Serial Quad I/O, SMART-I.S., SQI, SuperSwitcher, SuperSwitcher II, Total Endurance, TSHARC, USBCheck, VariSense, ViewSpan, WiperLock, Wireless DNA, and ZENA are trademarks of Microchip Technology Incorporated in the U.S.A. and other countries.

SQTP is a service mark of Microchip Technology Incorporated in the U.S.A.

Silicon Storage Technology is a registered trademark of Microchip Technology Inc. in other countries.

GestIC is a registered trademark of Microchip Technology Germany II GmbH & Co. KG, a subsidiary of Microchip Technology Inc., in other countries.

All other trademarks mentioned herein are property of their respective companies.

© 2017, Microchip Technology Incorporated, Printed in the U.S.A., All Rights Reserved.

ISBN: 978-1-5224-1665-4

## Quality Management System Certified by DNV

---

### ISO/TS 16949

Microchip received ISO/TS-16949:2009 certification for its worldwide headquarters, design and wafer fabrication facilities in Chandler and Tempe, Arizona; Gresham, Oregon and design centers in California and India. The Company's quality system processes and procedures are for its PIC<sup>®</sup> MCUs and dsPIC<sup>®</sup> DSCs, KEELOQ<sup>®</sup> code hopping devices, Serial EEPROMs, microperipherals, nonvolatile memory and analog products. In addition, Microchip's quality system for the design and manufacture of development systems is ISO 9001:2000 certified.

## Worldwide Sales and Service

AMERICAS	ASIA/PACIFIC	ASIA/PACIFIC	EUROPE
<p><b>Corporate Office</b> 2355 West Chandler Blvd. Chandler, AZ 85224-6199 Tel: 480-792-7200 Fax: 480-792-7277 Technical Support: <a href="http://www.microchip.com/support">http://www.microchip.com/support</a> Web Address: <a href="http://www.microchip.com">www.microchip.com</a></p> <p><b>Atlanta</b> Duluth, GA Tel: 678-957-9614 Fax: 678-957-1455</p> <p><b>Austin, TX</b> Tel: 512-257-3370</p> <p><b>Boston</b> Westborough, MA Tel: 774-760-0087 Fax: 774-760-0088</p> <p><b>Chicago</b> Itasca, IL Tel: 630-285-0071 Fax: 630-285-0075</p> <p><b>Dallas</b> Addison, TX Tel: 972-818-7423 Fax: 972-818-2924</p> <p><b>Detroit</b> Novi, MI Tel: 248-848-4000</p> <p><b>Houston, TX</b> Tel: 281-894-5983</p> <p><b>Indianapolis</b> Noblesville, IN Tel: 317-773-8323 Fax: 317-773-5453 Tel: 317-536-2380</p> <p><b>Los Angeles</b> Mission Viejo, CA Tel: 949-462-9523 Fax: 949-462-9608 Tel: 951-273-7800</p> <p><b>Raleigh, NC</b> Tel: 919-844-7510</p> <p><b>New York, NY</b> Tel: 631-435-6000</p> <p><b>San Jose, CA</b> Tel: 408-735-9110 Tel: 408-436-4270</p> <p><b>Canada - Toronto</b> Tel: 905-695-1980 Fax: 905-695-2078</p>	<p><b>Asia Pacific Office</b> Suites 3707-14, 37th Floor Tower 6, The Gateway Harbour City, Kowloon</p> <p><b>Hong Kong</b> Tel: 852-2943-5100 Fax: 852-2401-3431</p> <p><b>Australia - Sydney</b> Tel: 61-2-9868-6733 Fax: 61-2-9868-6755</p> <p><b>China - Beijing</b> Tel: 86-10-8569-7000 Fax: 86-10-8528-2104</p> <p><b>China - Chengdu</b> Tel: 86-28-8665-5511 Fax: 86-28-8665-7889</p> <p><b>China - Chongqing</b> Tel: 86-23-8980-9588 Fax: 86-23-8980-9500</p> <p><b>China - Dongguan</b> Tel: 86-769-8702-9880</p> <p><b>China - Guangzhou</b> Tel: 86-20-8755-8029</p> <p><b>China - Hangzhou</b> Tel: 86-571-8792-8115 Fax: 86-571-8792-8116</p> <p><b>China - Hong Kong SAR</b> Tel: 852-2943-5100 Fax: 852-2401-3431</p> <p><b>China - Nanjing</b> Tel: 86-25-8473-2460 Fax: 86-25-8473-2470</p> <p><b>China - Qingdao</b> Tel: 86-532-8502-7355 Fax: 86-532-8502-7205</p> <p><b>China - Shanghai</b> Tel: 86-21-3326-8000 Fax: 86-21-3326-8021</p> <p><b>China - Shenyang</b> Tel: 86-24-2334-2829 Fax: 86-24-2334-2393</p> <p><b>China - Shenzhen</b> Tel: 86-755-8864-2200 Fax: 86-755-8203-1760</p> <p><b>China - Wuhan</b> Tel: 86-27-5980-5300 Fax: 86-27-5980-5118</p> <p><b>China - Xian</b> Tel: 86-29-8833-7252 Fax: 86-29-8833-7256</p>	<p><b>China - Xiamen</b> Tel: 86-592-2388138 Fax: 86-592-2388130</p> <p><b>China - Zhuhai</b> Tel: 86-756-3210040 Fax: 86-756-3210049</p> <p><b>India - Bangalore</b> Tel: 91-80-3090-4444 Fax: 91-80-3090-4123</p> <p><b>India - New Delhi</b> Tel: 91-11-4160-8631 Fax: 91-11-4160-8632</p> <p><b>India - Pune</b> Tel: 91-20-3019-1500</p> <p><b>Japan - Osaka</b> Tel: 81-6-6152-7160 Fax: 81-6-6152-9310</p> <p><b>Japan - Tokyo</b> Tel: 81-3-6880-3770 Fax: 81-3-6880-3771</p> <p><b>Korea - Daegu</b> Tel: 82-53-744-4301 Fax: 82-53-744-4302</p> <p><b>Korea - Seoul</b> Tel: 82-2-554-7200 Fax: 82-2-558-5932 or 82-2-558-5934</p> <p><b>Malaysia - Kuala Lumpur</b> Tel: 60-3-6201-9857 Fax: 60-3-6201-9859</p> <p><b>Malaysia - Penang</b> Tel: 60-4-227-8870 Fax: 60-4-227-4068</p> <p><b>Philippines - Manila</b> Tel: 63-2-634-9065 Fax: 63-2-634-9069</p> <p><b>Singapore</b> Tel: 65-6334-8870 Fax: 65-6334-8850</p> <p><b>Taiwan - Hsin Chu</b> Tel: 886-3-5778-366 Fax: 886-3-5770-955</p> <p><b>Taiwan - Kaohsiung</b> Tel: 886-7-213-7830</p> <p><b>Taiwan - Taipei</b> Tel: 886-2-2508-8600 Fax: 886-2-2508-0102</p> <p><b>Thailand - Bangkok</b> Tel: 66-2-694-1351 Fax: 66-2-694-1350</p>	<p><b>Austria - Wels</b> Tel: 43-7242-2244-39 Fax: 43-7242-2244-393</p> <p><b>Denmark - Copenhagen</b> Tel: 45-4450-2828 Fax: 45-4485-2829</p> <p><b>Finland - Espoo</b> Tel: 358-9-4520-820</p> <p><b>France - Paris</b> Tel: 33-1-69-53-63-20 Fax: 33-1-69-30-90-79</p> <p><b>France - Saint Cloud</b> Tel: 33-1-30-60-70-00</p> <p><b>Germany - Garching</b> Tel: 49-8931-9700</p> <p><b>Germany - Haan</b> Tel: 49-2129-3766400</p> <p><b>Germany - Heilbronn</b> Tel: 49-7131-67-3636</p> <p><b>Germany - Karlsruhe</b> Tel: 49-721-625370</p> <p><b>Germany - Munich</b> Tel: 49-89-627-144-0 Fax: 49-89-627-144-44</p> <p><b>Germany - Rosenheim</b> Tel: 49-8031-354-560</p> <p><b>Israel - Ra'anana</b> Tel: 972-9-744-7705</p> <p><b>Italy - Milan</b> Tel: 39-0331-742611 Fax: 39-0331-466781</p> <p><b>Italy - Padova</b> Tel: 39-049-7625286</p> <p><b>Netherlands - Druen</b> Tel: 31-416-690399 Fax: 31-416-690340</p> <p><b>Norway - Trondheim</b> Tel: 47-7289-7561</p> <p><b>Poland - Warsaw</b> Tel: 48-22-3325737</p> <p><b>Romania - Bucharest</b> Tel: 40-21-407-87-50</p> <p><b>Spain - Madrid</b> Tel: 34-91-708-08-90 Fax: 34-91-708-08-91</p> <p><b>Sweden - Gothenberg</b> Tel: 46-31-704-60-40</p> <p><b>Sweden - Stockholm</b> Tel: 46-8-5090-4654</p> <p><b>UK - Wokingham</b> Tel: 44-118-921-5800 Fax: 44-118-921-5820</p>