

DIM.	TOL.
5mm DOWN	±0.2
5~20mm	±0.3
20~40mm	±0.4
40~60mm	±0.5
60~100mm	±0.8
100mm UP	±1.0

REVISIONS			
REV	DESCRIPTION	DATE	BY

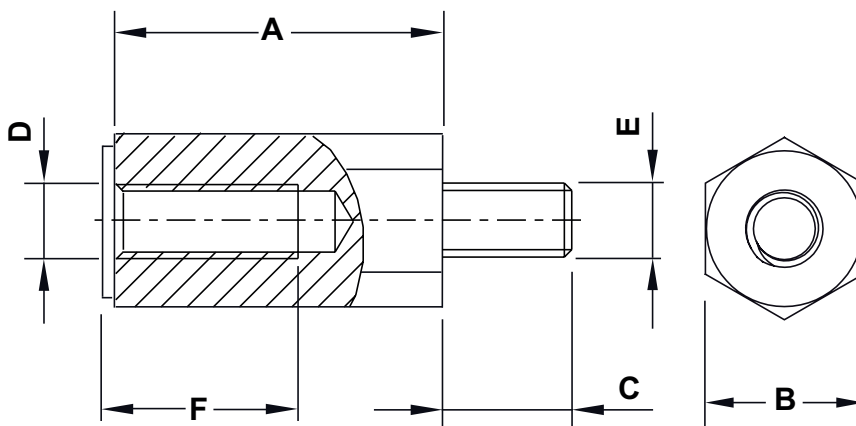

B	D - E	C	A
6,0	M3 / M3	8,0	5,0 - 61,0



By order pls add the length of the requested Part at the end of the Part No.

Example:

6920AA0108.00 for a Spacer with a length of 8.0 mm

Increments: 1,0 mm

Special request only:

Colour: White

Material code: AA02 instead of AA01 used

				TITLE <b>HEXAGONAL METRIC THREADED SPACER</b>			
				MATERIAL PA6.6 HB (UL94)		DATE 12/06/2017	
PART NUMBER 6922AA01		DRAWING NUMBER 17.06.12.6922.0.E		COLOR BLACK		CHECK	
SIZE A4	SCALE NTS	UNIT mm.	REV A	UNLESS OTHERWISE SPECIFIED TOLERANCE SEE ABOVE		APPROVED	