

C14 IEC Fused Inlet - Polyflange

VERTICAL MODULE ARRANGEMENT

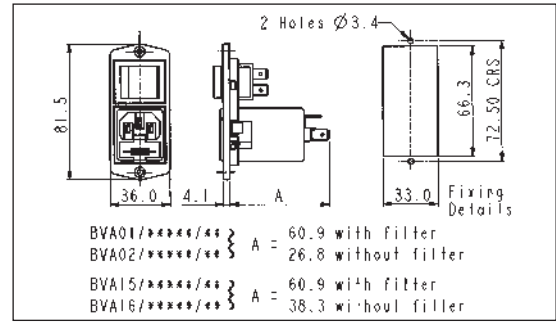

- Fused Inlet with 2.8mm or 6.3mm tags
- Screw Fixing to Panel
- Double Pole Switch Variations
- Filtered Inlet Option
- Options of I/O marked switches



VERTICAL MODULE ARRANGEMENT



- Fused Inlet with 2.8mm or 6.3mm tags
- Screw Fixing to Panel
- Double Pole Switch Variations
- Filtered Inlet Option
- Options of I/O marked switches

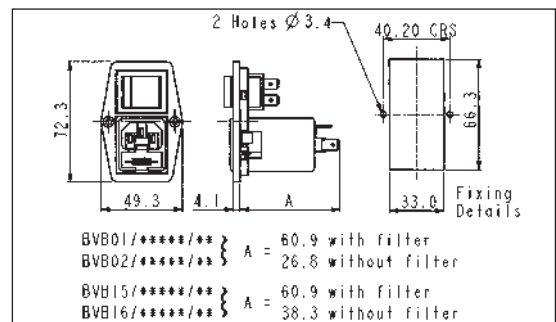

How to Order

BVx xx / xxxxx / xx

Flange Type	Type of Inlet / Outlet	Filtered or Non Filtered Inlet	Combination of Other Components
<p>A = Top fixing</p> <p>B = Side fixing</p>	<p>Fused C14 Power Inlet (cold condition), 6.3 or 2.8mm tabs:</p> <p>01 = PF0011/63 02 = PF0011/28</p> <p>Twin Fused C14 Power Inlet (cold condition), 6.3 or 2.8mm tabs:</p> <p>15 = PF0033/63 16 = PF0033/28</p>	<p>Z0000 = Non Filtered</p> <p>Axxxx = Standard</p> <p>Bxxxx = Medical (Twin Fuse Version only)</p> <div style="border: 1px solid black; padding: 5px; margin-top: 20px;"> <p>For Filtered inlet use 6th to 9th characters from filter ordering code see pages 127-129.</p> <p>E.g. BVA01/A0620/10</p> </div>	<p>Neon Indicator:</p> <p>D3 = Red Neon Indicator</p> <p>Double Pole Switch:</p> <p>10 = D.P. Switch</p> <p>Double Pole Neon Switch:</p> <p>11 = D.P. Red Neon Switch 12 = D.P. Green Neon Switch</p> <p>Double Pole High Inrush Switch:</p> <p>13 = D.P. High Inrush Switch</p> <p>Double Pole Switch Marked I/O:</p> <p>70 = D.P. Switch (I/O)</p> <p>Double Pole Neon Switch Marked (I/O):</p> <p>76 = D.P. Red Neon Switch (I/O) 77 = D.P. Green Neon Switch (I/O)</p> <p>Double Pole High Inrush Switch Marked (I/O):</p> <p>78 = D.P. High Inrush Switch (I/O) B1 = D.P. High Inrush Green Neon Switch (I/O)</p>

Note: For technical details of individual components please see page 106