

OY033S

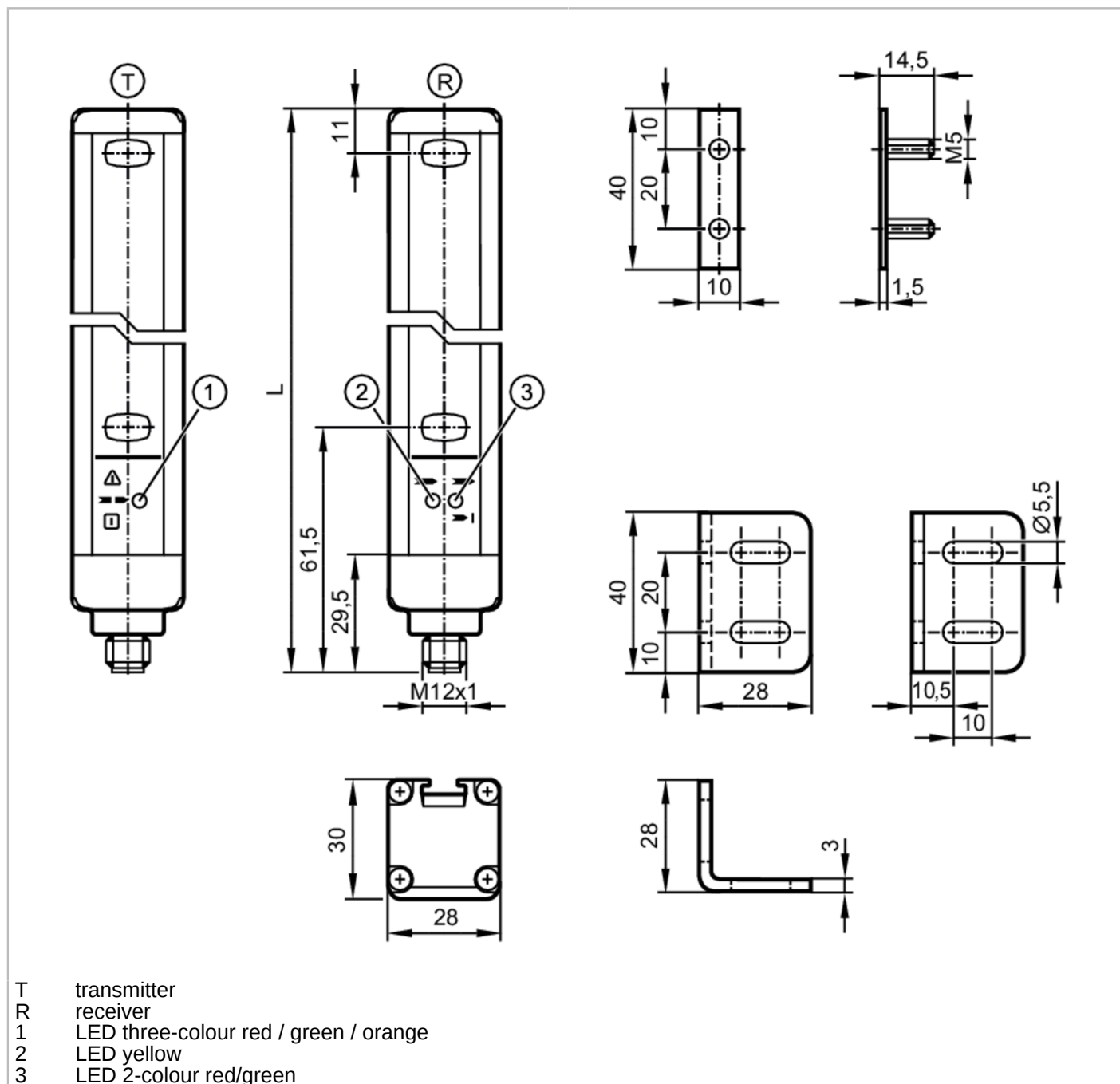

Safety light curtain

OYA0460-30-2-12-P-1



Product characteristics

Type of light	infrared light
Dimensions [mm]	513 x 28 x 30

Application

Protective function	access prevention hand protection
---------------------	-----------------------------------



Safety light curtain

OYA0460-30-2-12-P-1

Electrical data		
Operating voltage tolerance	[%]	20
Operating voltage	[V]	24 DC
Protection class		III
Reverse polarity protection		yes
Power-on delay time	[s]	< 2
Type of light		infrared light
Wave length	[nm]	950
Receiver		
Current consumption	[mA]	83
Transmitter		
Current consumption	[mA]	42
Outputs		
Electrical design		PNP
Number of OSSD outputs		2
Max. current load per OSSD output	[mA]	400; (24 V)
Short-circuit protection		yes
Detection zone		
Protected area height	[mm]	460
Resolution (detection capacity d)	[mm]	30
Protection area width (low light intensity)	[m]	0...4
Protection area width (high light intensity)	[m]	3...12
Response times		
Response time	[ms]	8
Operating conditions		
Applications		class C to EN 60654-1 weatherproof application
Ambient temperature	[°C]	-10...55
Storage temperature	[°C]	-20...70
Max. relative air humidity	[%]	95
Protection		IP 65; IP 67
Tests / approvals		
EMC		IEC 61496-1
Shock resistance		IEC 61496-1
Vibration resistance		IEC 61496-1
Safety classification		
ESPE type (IEC 61496-1)		2
ISO 13849-1		category 2, PL c
IEC 62061		SIL cl 1
Mission time TM	[h]	175200
Safety-related reliability PFHD	[1/h]	3.3E-08

OY033S



Safety light curtain

OYA0460-30-2-12-P-1

Mechanical data		
Weight	[g]	2264
Dimensions	[mm]	513 x 28 x 30
Materials		housing: aluminium; front lens: PC
Length L	[mm]	513
Displays / operating elements		
Display	transmitter	1 x LED
	receiver	2 x LED
Accessories		
Accessories (supplied)	mounting bracket: 4	
	slot nuts: 4	
	Nuts	
Remarks		
Notes	For 8-pole sockets the core colours are not standardised.; Please note the wiring of the sensor and the sockets (see data sheet).	
Pack quantity	1 pcs.	

Electrical connection - receiver

Connector: 1 x M12; Maximum cable length: 100 m; for wire cross-section 0.34 mm²

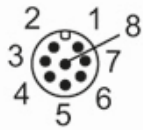

OY033S



Safety light curtain

OYA0460-30-2-12-P-1

Connection



Electrical connection - transmitter

Connector: 1 x M12



OY033S



Safety light curtain

OYA0460-30-2-12-P-1

Connection

