

**MCS POWER SUPPLY 1-PHASE,**

IN: 95-132VAC OUT: 24-28V/20ADC

INPUT: 95...132 V AC

OUTPUT: 24...28 V DC

Current: 20 A

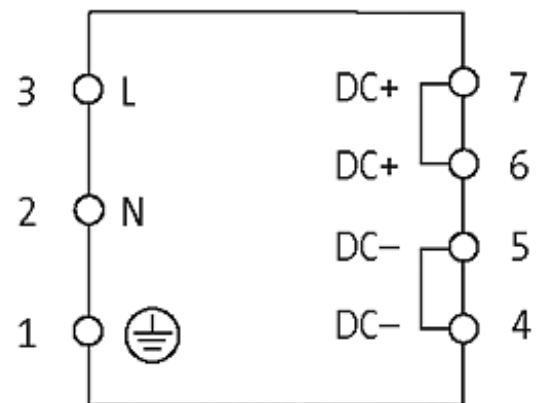
[Link to Product](#)**Illustration**

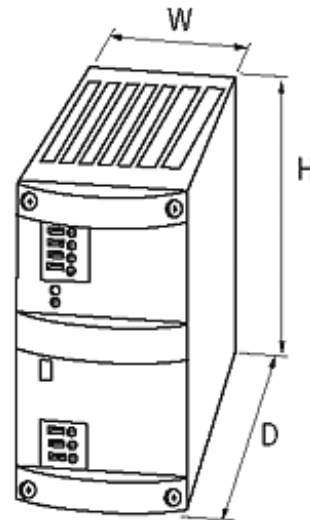

Product may differ from Image

### Approvals



### Input

Input voltage	95...132 V AC
Input current	8.4 A (115 V AC)
Primary fusing external	max. 16 A
Frequency	50...60 Hz

### General data

Standards	(EN 60950-1), (EN 61204-3), (EN 55022 B)
Relative humidity	5...95 %, no condensation
Efficiency	90 %
Mounting method	DIN-rail mountable TH35 (EN 60715)
Dimensions H x W x D	170x84x201 mm
Temperature range	0...+60 °C (storage temperature -25...+85 °C)

### Output

Output voltage	24 V DC (SELV), $\pm 1$ %; 24...28 V adjustable
Output current	20 A (+60 °C); 24 A (+40 °C)
Mains failure bridging time	min. 20 ms (115 V AC)
Ripple	max. 20 mVrms
Spikes	max. 250 mV p-p
Unit protection	short-circuit and overload protected
LED display	LED (green) for output voltage
Selectable switch-off mode	front sided plug link (automatic re-start or definite shut-off)
Parallel usage/serial usage	yes/yes

**Commercial data**

country of origin	CZ
customs tariff number	85044090
minimum order quantity	1