

Silicon PIN Photodiode



21726

FEATURES

- Package type: surface mount
- Package form: GW, RGW
- Dimensions (L x W x H in mm): 6.4 x 3.9 x 1.2
- Radiant sensitive area (in mm²): 7.5
- High radiant sensitivity
- Daylight blocking filter matched with 870 nm to 950 nm emitters
- Fast response times
- Angle of half sensitivity: $\phi = \pm 65^\circ$
- Floor life: 168 h, MSL 3, acc. J-STD-020
- Lead (Pb)-free reflow soldering
- Compliant to RoHS Directive 2002/95/EC and in accordance to WEEE 2002/96/EC
- Halogen-free according to IEC 61249-2-21 definition

RoHS
 COMPLIANT
 HALOGEN
FREE

DESCRIPTION

VBPW34FAS and VBPW34FASR are high speed and high sensitive PIN photodiodes. It is a surface mount device (SMD) including the chip with a 7.5 mm² sensitive area and a daylight blocking filter matched with IR emitters operating at wavelength 870 nm or 950 nm.

APPLICATIONS

- High speed detector for infrared radiation
- Infrared remote control and free air data transmissionsystems, e.g. in combination with TSFFxxxx

PRODUCT SUMMARY

COMPONENT	I_{ra} (μ A)	ϕ (deg)	$\lambda_{0.5}$ (nm)
VBPW34FAS	55	± 65	780 to 1050
VBPW34FASR	55	± 65	780 to 1050

Note

- Test conditions see table "Basic Characteristics"

ORDERING INFORMATION

ORDERING CODE	PACKAGING	REMARKS	PACKAGE FORM
VBPW34FAS	Tape and reel	MOQ: 1000 pcs, 1000 pcs/reel	Gullwing
VBPW34FASR	Tape and reel	MOQ: 1000 pcs, 1000 pcs/reel	Reverse gullwing

Note

- MOQ: minimum order quantity

ABSOLUTE MAXIMUM RATINGS (T_{amb} = 25 °C, unless otherwise specified)

PARAMETER	TEST CONDITION	SYMBOL	VALUE	UNIT
Reverse voltage		V_R	60	V
Power dissipation	$T_{amb} \leq 25^\circ\text{C}$	P_V	215	mW
Junction temperature		T_j	100	°C
Operating temperature range		T_{amb}	- 40 to + 100	°C
Storage temperature range		T_{stg}	- 40 to + 100	°C
Soldering temperature	Acc. reflow sloder profile fig. 8	T_{sd}	260	°C
Thermal resistance junction/ambient		R_{thJA}	350	K/W



BASIC CHARACTERISTICS (T _{amb} = 25 °C, unless otherwise specified)						
PARAMETER	TEST CONDITION	SYMBOL	MIN.	TYP.	MAX.	UNIT
Forward voltage	I _F = 50 mA	V _F		1	1.3	V
Breakdown voltage	I _R = 100 μA, E = 0	V _(BR)	60			V
Reverse dark current	V _R = 10 V, E = 0	I _{ro}		2	30	nA
Diode capacitance	V _R = 0 V, f = 1 MHz, E = 0	C _D		70		pF
	V _R = 3 V, f = 1 MHz, E = 0	C _D		25	40	pF
Open circuit voltage	E _e = 1 mW/cm ² , λ = 950 nm	V _o		350		mV
Temperature coefficient of V _o	E _e = 1 mW/cm ² , λ = 950 nm	TK _{V_o}		- 2.6		mV/K
Short circuit current	E _e = 1 mW/cm ² , λ = 950 nm	I _k		50		μA
Temperature coefficient of I _k	E _e = 1 mW/cm ² , λ = 950 nm	TK _{I_k}		0.1		%/K
Reverse light current	E _e = 1 mW/cm ² , λ = 950 nm, V _R = 5 V	I _{ra}	45	55		μA
Angle of half sensitivity		φ		± 65		deg
Wavelength of peak sensitivity		λ _p		950		nm
Range of spectral bandwidth		λ _{0.5}		780 to 1050		nm
Noise equivalent power	V _R = 10 V, λ = 950 nm	NEP		4 x 10 ⁻¹⁴		W/√Hz
Rise time	V _R = 10 V, R _L = 1 kΩ, λ = 820 nm	t _r		100		ns
Fall time	V _R = 10 V, R _L = 1 kΩ, λ = 820 nm	t _f		100		ns

BASIC CHARACTERISTICS (T_{amb} = 25 °C, unless otherwise specified)



Fig. 1 - Reverse Dark Current vs. Ambient Temperature



Fig. 2 - Relative Reverse Light Current vs. Ambient Temperature



12787

Fig. 3 - Reverse Light Current vs. Irradiance



21743

Fig. 6 - Relative Spectral Sensitivity vs. Wavelength

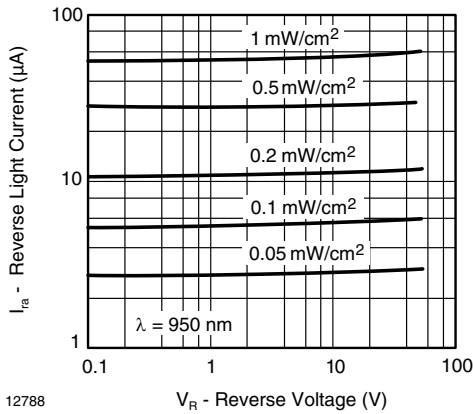

12788

Fig. 4 - Reverse Light Current vs. Reverse Voltage

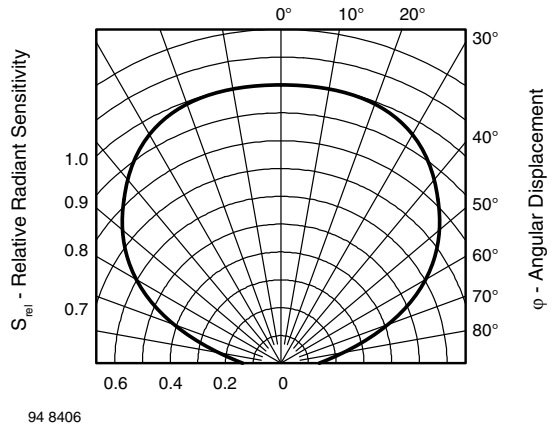

94 8406

Fig. 7 - Relative Radiant Sensitivity vs. Angular Displacement



948407

Fig. 5 - Diode Capacitance vs. Reverse Voltage



PACKAGE DIMENSIONS FOR VBPW34FAS in millimeters

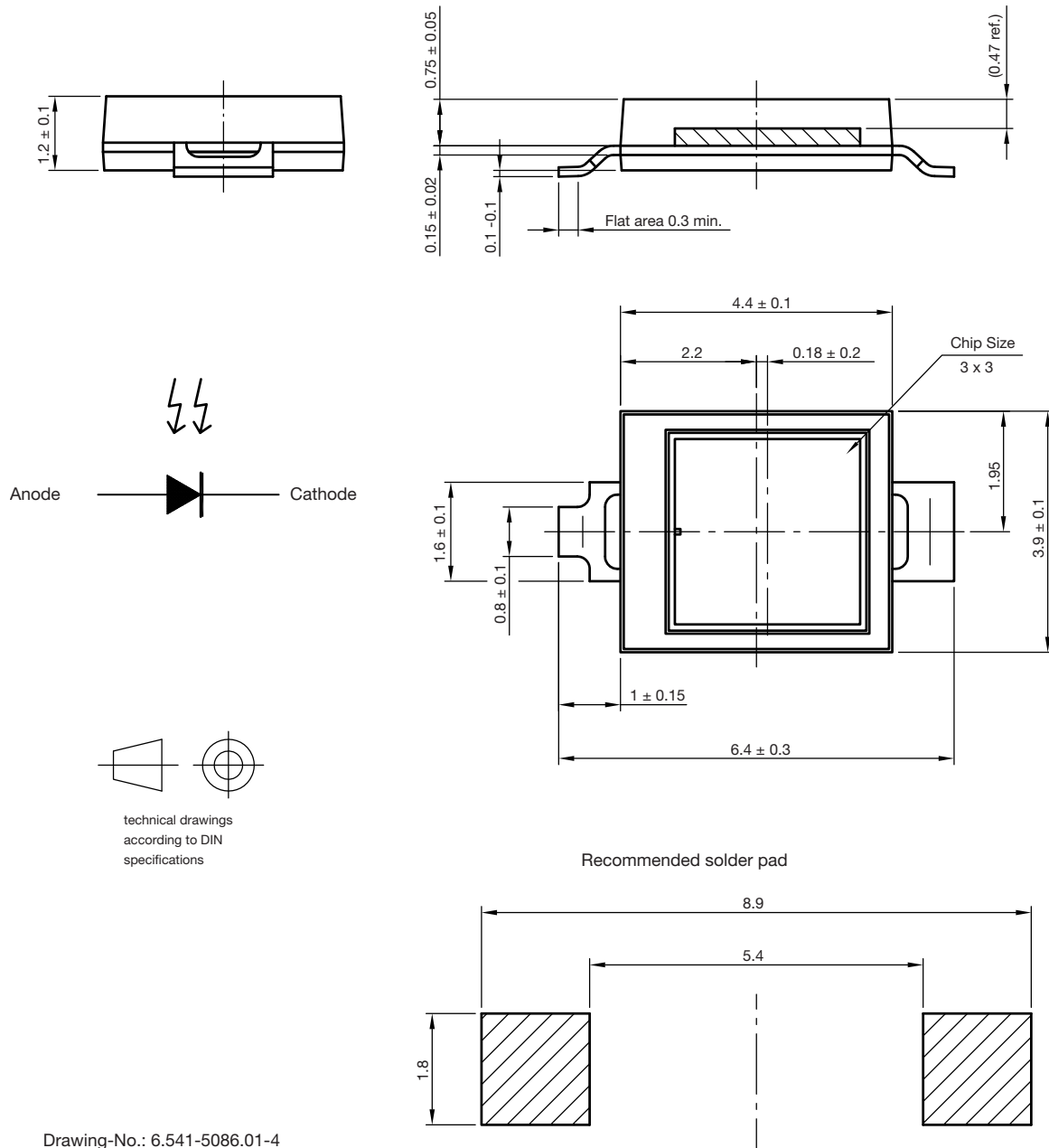

Anode Cathode

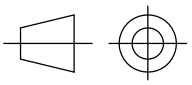

technical drawings according to DIN specifications

Drawing-No.: 6.541-5086.01-4
Issue: 1; 15.04.10
22105



PACKAGE DIMENSIONS FOR VBPW34FASR in millimeters

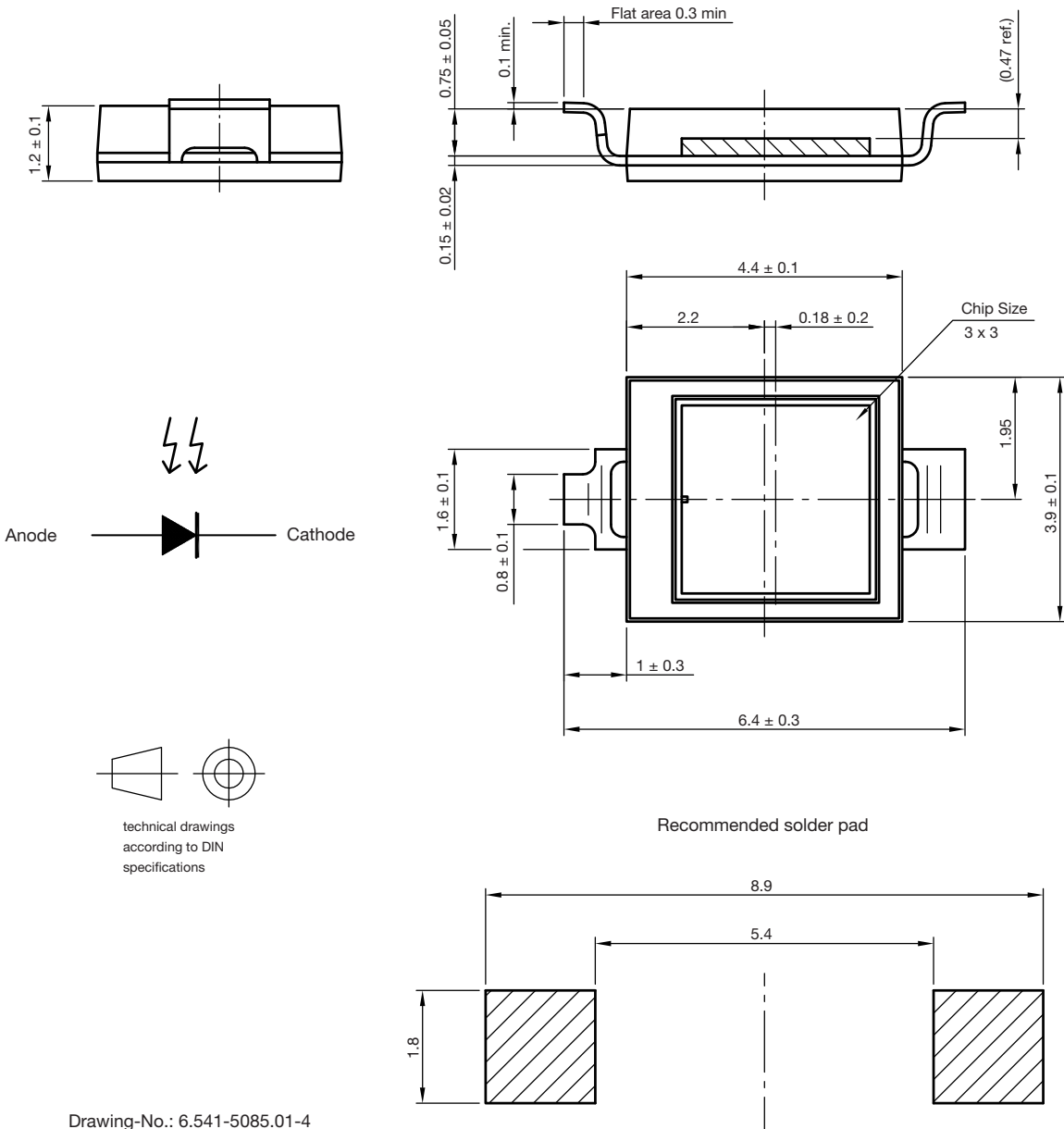

Drawing-No.: 6.541-5085.01-4

Issue: 1; 15.04.10

22104



TAPING DIMENSIONS FOR VBPW34FAS in millimeters

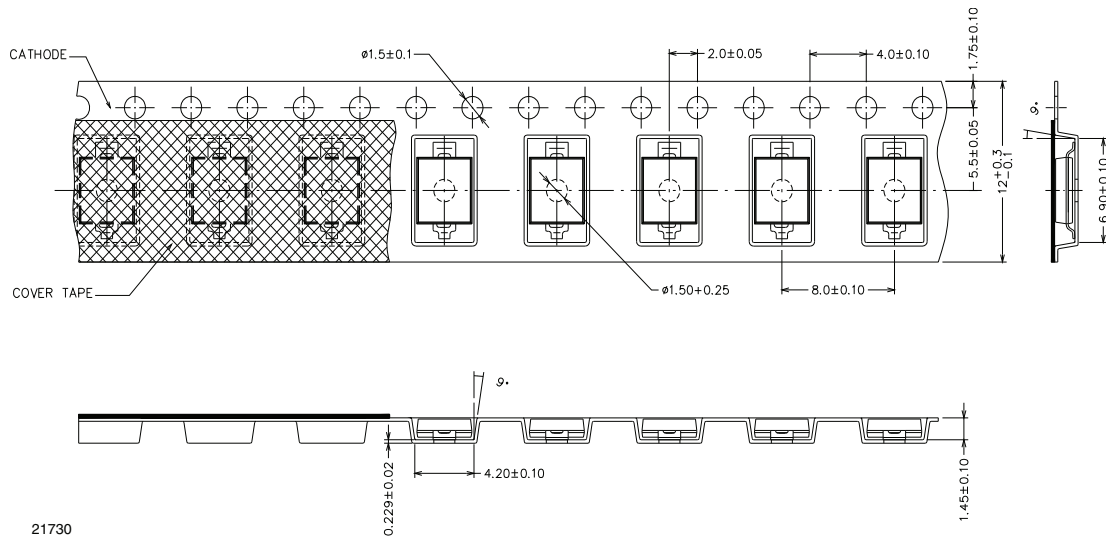

TAPING DIMENSIONS FOR VBPW34FASR in millimeters



REEL DIMENSIONS FOR VBPW34FAS AND VBPW34FASR in millimeters



21732

SOLDER PROFILE

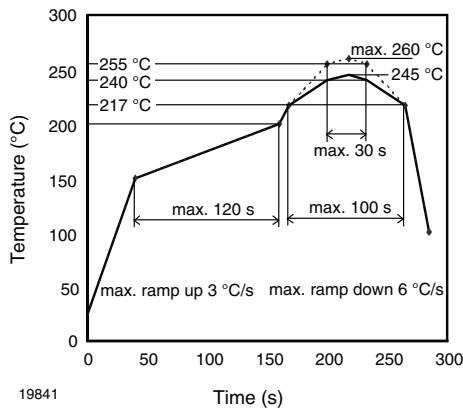

19841

Fig. 8 - Lead (Pb)-free Reflow Solder Profile acc. J-STD-020

DRYPACK

Devices are packed in moisture barrier bags (MBB) to prevent the products from moisture absorption during transportation and storage. Each bag contains a desiccant.

FLOOR LIFE

Time between soldering and removing from MBB must not exceed the time indicated in J-STD-020:

Moisture sensitivity: level 3

Floor life: 168 h

Conditions: $T_{amb} < 30\text{ }^{\circ}\text{C}$, RH < 60 %

DRYING

In case of moisture absorption devices should be baked before soldering. Conditions see J-STD-020 or recommended conditions:

192 h at 40 °C (+ 5 °C), RH < 5 %

or

96 h at 60 °C (+ 5 °C), RH < 5 %.



Disclaimer

ALL PRODUCT, PRODUCT SPECIFICATIONS AND DATA ARE SUBJECT TO CHANGE WITHOUT NOTICE TO IMPROVE RELIABILITY, FUNCTION OR DESIGN OR OTHERWISE.

Vishay Intertechnology, Inc., its affiliates, agents, and employees, and all persons acting on its or their behalf (collectively, "Vishay"), disclaim any and all liability for any errors, inaccuracies or incompleteness contained in any datasheet or in any other disclosure relating to any product.

Vishay makes no warranty, representation or guarantee regarding the suitability of the products for any particular purpose or the continuing production of any product. To the maximum extent permitted by applicable law, Vishay disclaims (i) any and all liability arising out of the application or use of any product, (ii) any and all liability, including without limitation special, consequential or incidental damages, and (iii) any and all implied warranties, including warranties of fitness for particular purpose, non-infringement and merchantability.

Statements regarding the suitability of products for certain types of applications are based on Vishay's knowledge of typical requirements that are often placed on Vishay products in generic applications. Such statements are not binding statements about the suitability of products for a particular application. It is the customer's responsibility to validate that a particular product with the properties described in the product specification is suitable for use in a particular application. Parameters provided in datasheets and/or specifications may vary in different applications and performance may vary over time. All operating parameters, including typical parameters, must be validated for each customer application by the customer's technical experts. Product specifications do not expand or otherwise modify Vishay's terms and conditions of purchase, including but not limited to the warranty expressed therein.

Except as expressly indicated in writing, Vishay products are not designed for use in medical, life-saving, or life-sustaining applications or for any other application in which the failure of the Vishay product could result in personal injury or death. Customers using or selling Vishay products not expressly indicated for use in such applications do so at their own risk. Please contact authorized Vishay personnel to obtain written terms and conditions regarding products designed for such applications.

No license, express or implied, by estoppel or otherwise, to any intellectual property rights is granted by this document or by any conduct of Vishay. Product names and markings noted herein may be trademarks of their respective owners.

Material Category Policy

Vishay Intertechnology, Inc. hereby certifies that all its products that are identified as RoHS-Compliant fulfill the definitions and restrictions defined under Directive 2011/65/EU of The European Parliament and of the Council of June 8, 2011 on the restriction of the use of certain hazardous substances in electrical and electronic equipment (EEE) - recast, unless otherwise specified as non-compliant.

Please note that some Vishay documentation may still make reference to RoHS Directive 2002/95/EC. We confirm that all the products identified as being compliant to Directive 2002/95/EC conform to Directive 2011/65/EU.

Vishay Intertechnology, Inc. hereby certifies that all its products that are identified as Halogen-Free follow Halogen-Free requirements as per JEDEC JS709A standards. Please note that some Vishay documentation may still make reference to the IEC 61249-2-21 definition. We confirm that all the products identified as being compliant to IEC 61249-2-21 conform to JEDEC JS709A standards.