

USB3 female to female keystone coupler, wired 1:1



USB3 A female to A female keystone coupler (KCUAA311wh)

This USB3 keystone coupler can be used as an interconnection point between two A-A cables. With its standardised dimensions it can be used for easy snap-in mounting in a keystone patch panel, face plate or surface-mount box.

Features

- USB 3.0 style keystone coupler type (A female connectors on the front and back)
- Wired pin 1 : 1 and clearly marked with wiring
- Connection from and to USB1.1, USB2.0 and USB3.0
- Standard format keystone fits a wide range of panels, adaptors and faceplates
- Available as part of our innovative new panel mount and D UNIVERSAL range

Specifications:

- Dimensions (LxWxH): approx. 34.3x16.2x19.5mm
- Weight: approx. 10g
- Housing: ABS UL94V-0
- Colour: white
- Connection: USB3.0 F/F

ROHS Compliant

Code: KCUAA311wh

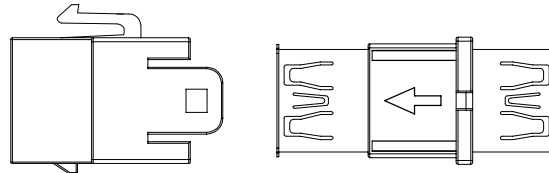
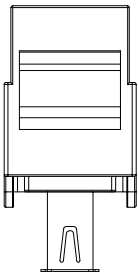
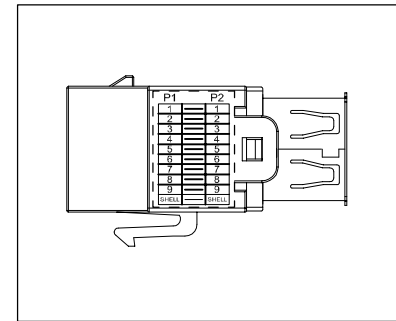
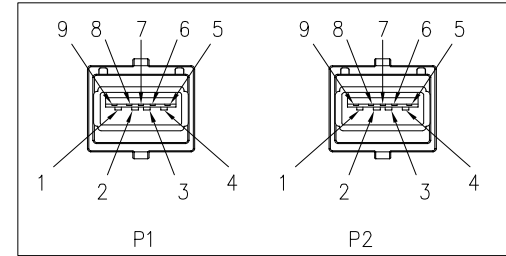
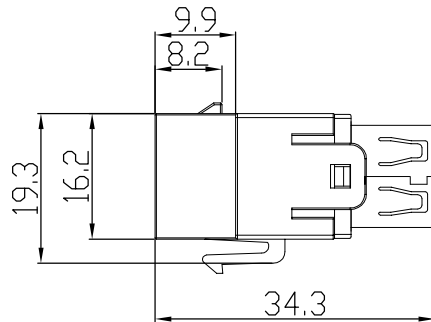
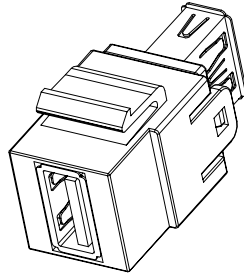
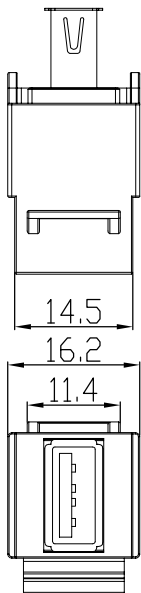

P1 P2

1	—	1
2	—	2
3	—	3
4	—	4
5	—	5
6	—	6
7	—	7
8	—	8
9	—	9
SHELL	—	SHELL