



# EVL3438-TL-00A

## 2A, 16V, High-Efficiency, Fully Integrated, Synchronous Boost Converter Evaluation Board

### DESCRIPTION

The EVL3438-TL-00A is an evaluation board designed to demonstrate the capabilities of the MP3438, a 1.2MHz, fixed-frequency, high-efficiency, fully integrated, synchronous boost converter with a wide input supply range.

The MP3438 starts from an input voltage ( $V_{IN}$ ) as low as 2.7V and supports up to 2A of switching current limit with integrated, low on resistance power MOSFETs.

The MP3438 adopts constant-off-time (COT) control topology to provide fast transient

response. The MP3438 also supports automatic pass-through functionality when  $V_{IN}$  exceeds  $V_{OUT-SET}$ , which can support high efficiency even when the input exceeds the output regulation.

The MP3438 is available in a SOT583 (1.6mmx2.1mm) package.

It is recommended to read the MP3438 datasheet prior to making any changes to the EVL3438-TL-00A.

### PERFORMANCE SUMMARY

Specifications are at  $T_A = 25^\circ\text{C}$ , unless otherwise noted.

Parameters	Conditions	Value
Input voltage ( $V_{IN}$ ) range		3V to 10V
Output voltage ( $V_{OUT}$ )	$V_{IN} = 3\text{V to } 10\text{V}$ , $I_{OUT} = 0\text{A to } 0.3\text{A}$	12V
Maximum output current ( $I_{OUT}$ )	$V_{IN} = 3\text{V to } 10\text{V}$	0.3A to 1.2A <sup>(1)</sup>
Full load efficiency	$V_{IN} = 3.3\text{V}$ , $V_{OUT} = 12\text{V}$ , $I_{OUT} = 0.3\text{A}$ , $f_{sw} = 1.2\text{MHz}$	91.2%
Switching frequency ( $f_{sw}$ )		1.2MHz

**Note:**

1) The maximum  $I_{OUT}$  range is affected by  $V_{IN}$ . See the Load Capability curve on page 5 for more details.

 Optimized Performance with MPS Inductor MPL-AL4020 Series

### EVALUATION BOARD

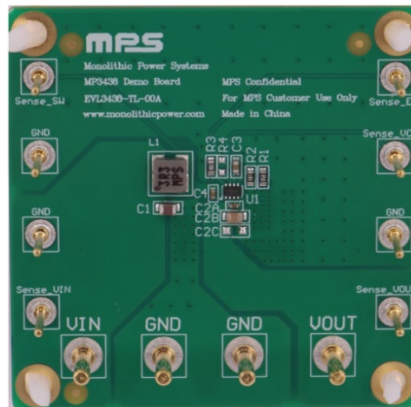

**LxWxH (5.1cmx5.1cmx0.6cm)**  
**2 Layers, 1oz/1oz**

Board Number	MPS IC Number
EVL3438-TL-00A	MP3438GTL

## QUICK START GUIDE

The EVL3438-TL-00A evaluation board is easy to set up and use to evaluate the performance of the MP3438. For proper measurement equipment set-up, refer to Figure 1 and follow the steps below:

1. Preset the power supply ( $V_{IN}$ ) between 3V and 10V, then turn off the power supply.
2. Connect the power supply terminals to:
  - a. Positive (+):  $V_{IN}$
  - b. Negative (-): GND
3. Connect the load terminals to:
  - a. Positive (+):  $V_{OUT}$
  - b. Negative (-): GND
4. After making the connections, turn on the power supply.
5. Limit the inrush current through the high-side MOSFET (HS-FET) body diode to below 6A. Refer to the Input Start-Up Inrush Current Control section in the MP3438 datasheet for more details.
6. Check for the proper output voltage ( $V_{OUT}$ ) between the SENSE\_VOUT to GND terminals.
7. Once the proper  $V_{OUT}$  is established, adjust the load within the operating range, then measure the efficiency, output ripple voltage, and other parameters.
8. After completing all tests, adjust the load to 0A, then turn off the input power supply.
9. If the auto-pass-through function is required, increase input voltage ( $V_{IN}$ ) to significantly exceed  $V_{OUT-SET}$ . The MP3438 enters pass-through automatically.

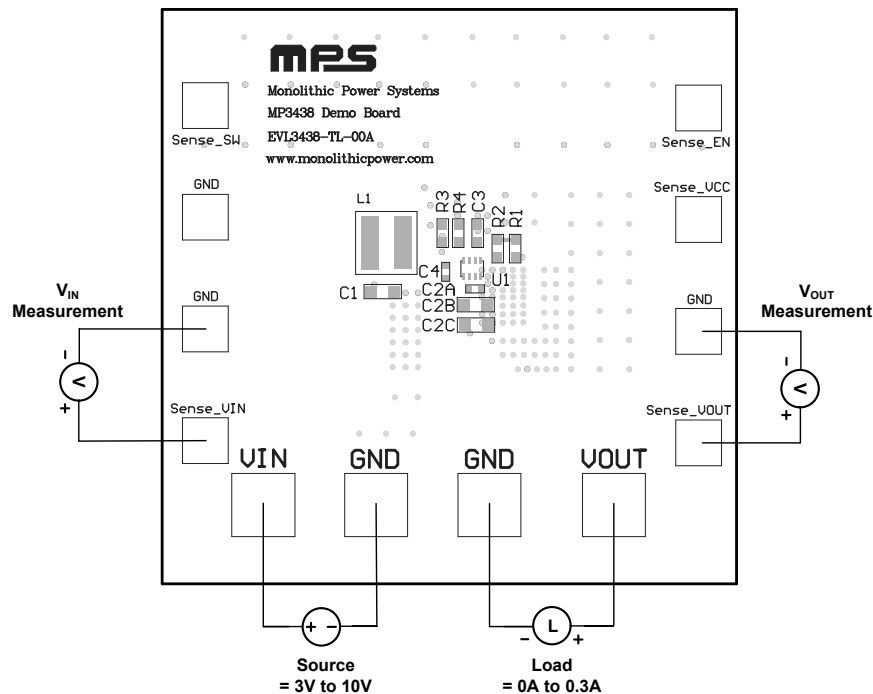

Figure 1: Proper Measurement Equipment Set-Up

### EVALUATION BOARD SCHEMATIC

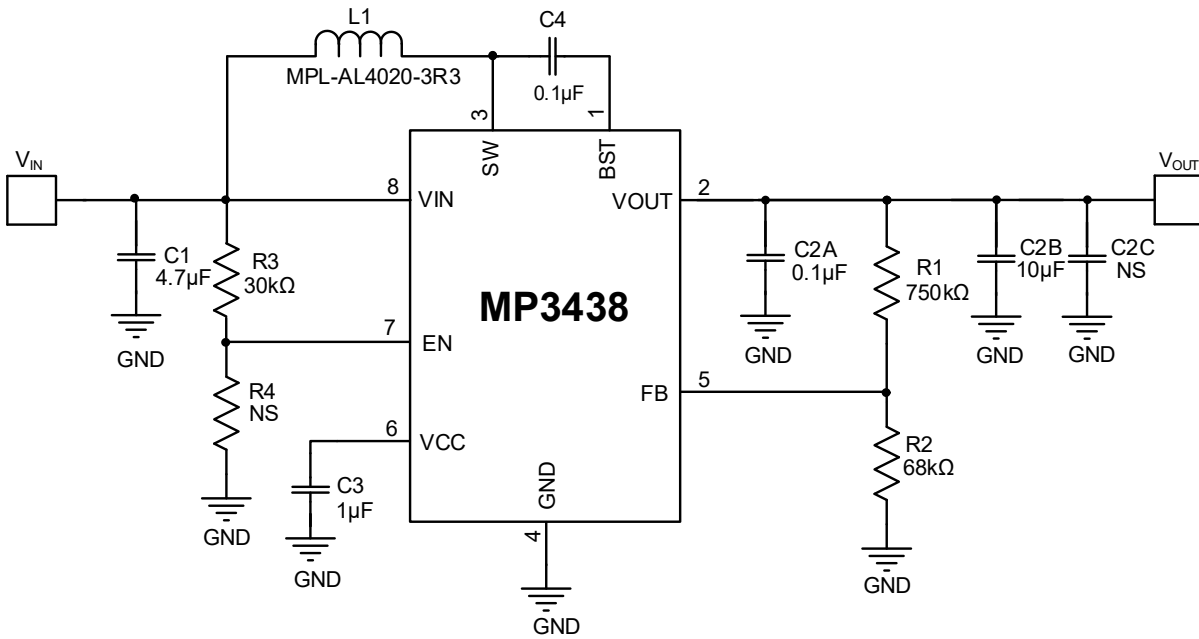

Figure 2: Evaluation Board Schematic

**EVL3438-TL-00A BILL OF MATERIALS**

Qty	Ref	Value	Description	Package	Manufacturer	Manufacturer PN
1	C1	4.7 $\mu$ F	Ceramic capacitor, 25V, X7S	0805	Murata	GRM21BC71E475KE11L
2	C2A, C4	0.1 $\mu$ F	Ceramic capacitor, 25V, X7R	0402	Murata	GRM155R71E104ME14D
1	C2B	10 $\mu$ F	Ceramic capacitor, 25V, X5R	0805	Murata	GRM21BR61E106KE43L
1	C3	1 $\mu$ F	Ceramic capacitor, 10V, X5R	0603	Murata	GRM188R61A105KA61D
1	R1	750k $\Omega$	Film resistor, 1%	0603	Yageo	RC0603FR-07750KL
1	R2	68k $\Omega$	Film resistor, 1%	0603	Yageo	RC0603FR-0768KL
1	R3	30k $\Omega$	Film resistor, 1%	0603	Yageo	RC0603FR-0730KL
0	R4, C2C	NS				
1	L1	3.3 $\mu$ H	Inductor, R <sub>DC</sub> = 34.5m $\Omega$ , I <sub>SAT</sub> = 5.2A	SMD	MPS	MPL-AL4020-3R3
1	U1	MP3438	2A, 16V, synchronous boost converter	SOT583	MPS	MP3438GTL

## EVB TEST RESULTS

Performance curves and waveforms are tested on the evaluation board,  $V_{IN} = 3.3V$ ,  $V_{OUT} = 12V$ ,  $L = 3.3\mu H$ ,  $I_{OUT} = 0.3A$ ,  $T_A = 25^\circ C$ , unless otherwise noted.

**Efficiency vs. Load Current**

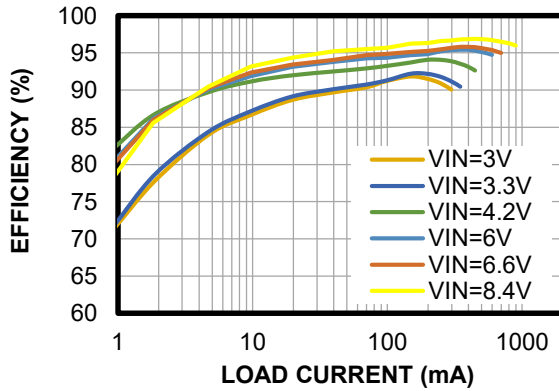

**Load Capability**

Current limit = 1.8A

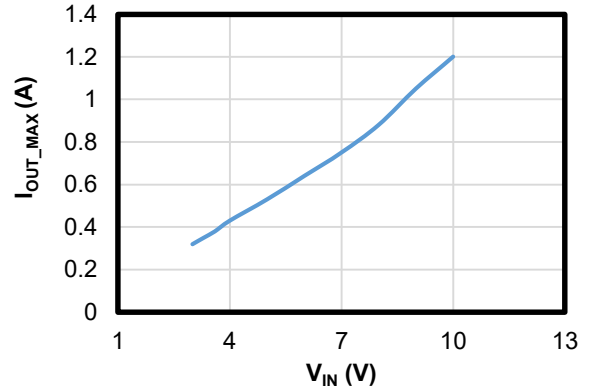

### Thermal Performance

$V_{IN} = 3.3V$ ,  $I_{OUT} = 0.3A$ ,  $T_A = 30^\circ C$ , no forced airflow

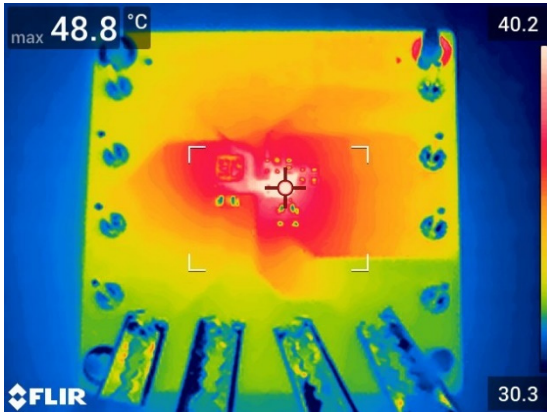

### EVB TEST RESULTS *(continued)*

Performance curves and waveforms are tested on the evaluation board,  $V_{IN} = 3.3V$ ,  $V_{OUT} = 12V$ ,  $L = 3.3\mu H$ ,  $I_{OUT} = 0.3A$ ,  $T_A = 25^\circ C$ , unless otherwise noted.

#### Steady State

$I_{OUT} = 0.3A$

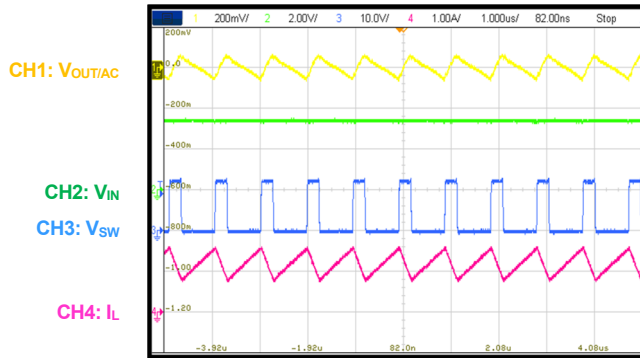

#### Load Transient

$I_{OUT} = 0.15A$  to  $0.3A$ , slew rate =  $2.5A/\mu s$   
(e-load)

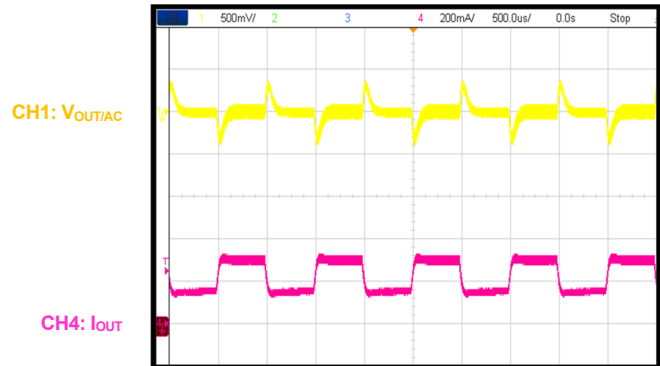

### PCB LAYOUT

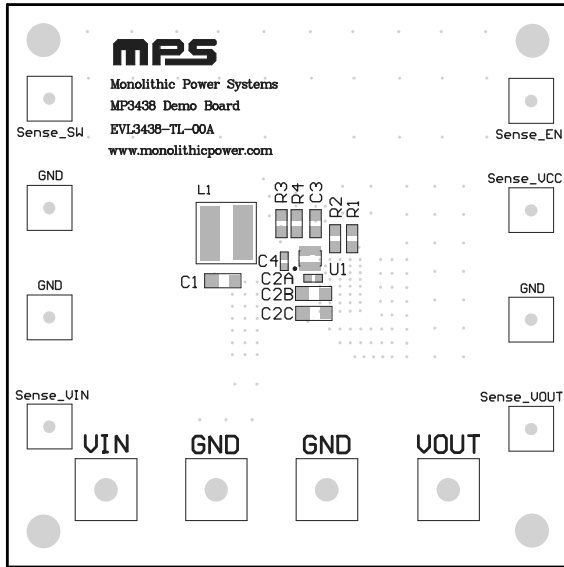

Figure 3: Top Silk

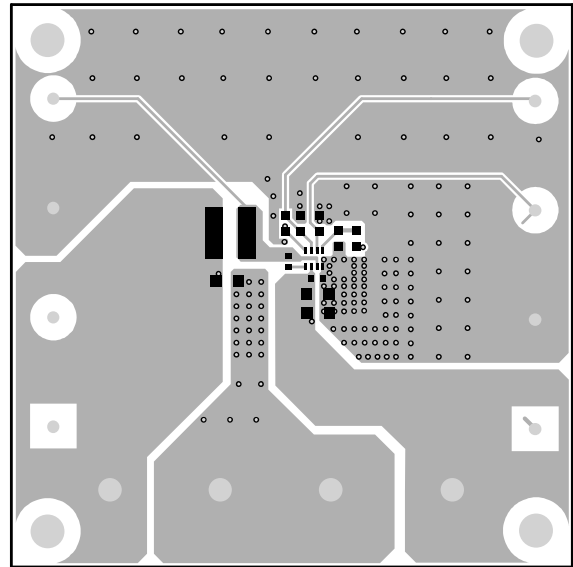

Figure 4: Top Layer

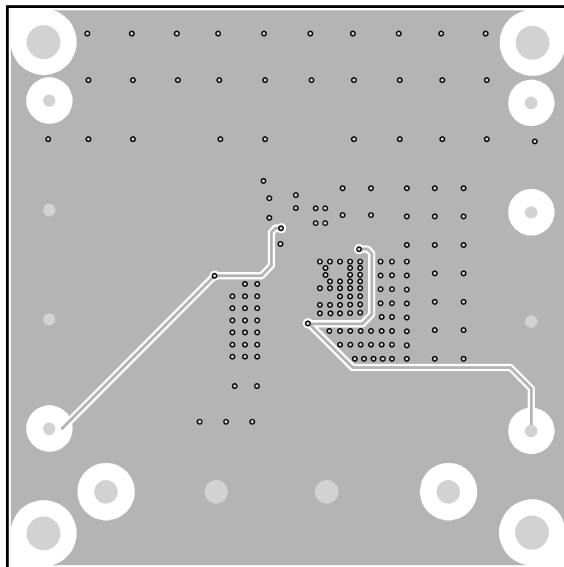

Figure 5: Bottom Layer



## REVISION HISTORY

Revision #	Revision Date	Description	Pages Updated
1.0	1/18/2022	Initial Release	-

**Notice:** The information in this document is subject to change without notice. Please contact MPS for current specifications. Users should warrant and guarantee that third-party Intellectual Property rights are not infringed upon when integrating MPS products into any application. MPS will not assume any legal responsibility for any said applications.