



**SEMITRANS® 3**

## Trench IGBT Module

**SKM 400GB126D**

**SKM 400GAL126D**

Preliminary Data

### Features

- Homogeneous Si
- Trench = Trenchgate technology
- $V_{CEsat}$  with positive temperature coefficient
- High short circuit capability, self limiting to  $6 \times I_C$

### Typical Applications

- AC inverter drives
- UPS
- Electronic welders

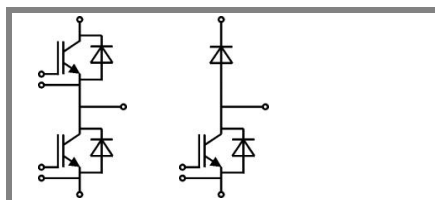

GB

GAL

Absolute Maximum Ratings		$T_C = 25\text{ °C}$ , unless otherwise specified		
Symbol	Conditions	Values		Units
<b>IGBT</b>				
$V_{CES}$	$T_j = 25\text{ °C}$	1200		V
$I_C$	$T_j = 150\text{ °C}$	$T_{case} = 25\text{ °C}$	470	A
		$T_{case} = 80\text{ °C}$	330	A
$I_{CRM}$	$I_{CRM} = 2 \times I_{Cnom}$	600		A
$V_{GES}$		± 20		V
$t_{psc}$	$V_{CC} = 600\text{ V}; V_{GE} \leq 20\text{ V}; T_j = 125\text{ °C}$ $V_{CES} < 1200\text{ V}$	10		µs
<b>Inverse Diode</b>				
$I_F$	$T_j = 150\text{ °C}$	$T_{case} = 25\text{ °C}$	400	A
		$T_{case} = 80\text{ °C}$	270	A
$I_{FRM}$	$I_{FRM} = 2 \times I_{Fnom}$	600		A
$I_{FSM}$	$t_p = 10\text{ ms}; \sin.$	$T_j = 150\text{ °C}$	2200	
<b>Freewheeling Diode</b>				
$I_F$	$T_j = 150\text{ °C}$	$T_{case} = 25\text{ °C}$	400	A
		$T_{case} = 80\text{ °C}$	270	A
$I_{FRM}$	$I_{FRM} = 2 \times I_{Fnom}; t_p = 1\text{ ms}$	600		A
$I_{FSM}$	$t_p = 10\text{ ms}; \sin.$	$T_j = 150\text{ °C}$	2200	
<b>Module</b>				
$I_{t(RMS)}$		500		A
$T_{vj}$		- 40 ... + 150		°C
$T_{stg}$		- 40 ... + 125		°C
$V_{isol}$	AC, 1 min.	4000		V

Characteristics		$T_C = 25\text{ °C}$ , unless otherwise specified			
Symbol	Conditions	min.	typ.	max.	Units
<b>IGBT</b>					
$V_{GE(th)}$	$V_{GE} = V_{CE}; I_C = 12\text{ mA}$	5	5,8	6,5	V
$I_{CES}$	$V_{GE} = 0\text{ V}; V_{CE} = V_{CES}$		0,15	0,45	mA
$V_{CE0}$		$T_j = 25\text{ °C}$	1	1,2	V
		$T_j = 125\text{ °C}$	0,9		V
$r_{CE}$	$V_{GE} = 15\text{ V}$	$T_j = 25\text{ °C}$	2,3	3,2	mΩ
		$T_j = 125\text{ °C}$	3,7		mΩ
$V_{CE(sat)}$	$I_{Cnom} = 300\text{ A}; V_{GE} = 15\text{ V}$	$T_j = 25\text{ °C}_{chiplev.}$	1,7	2,15	V
		$T_j = 125\text{ °C}_{chiplev.}$	2		V
$C_{ies}$	$V_{CE} = 25; V_{GE} = 0\text{ V}$	$f = 1\text{ MHz}$	23,1		nF
$C_{oes}$			1,9		nF
$C_{res}$			1,2		nF
$Q_G$	$V_{GE} = -8\text{ V} \dots +20\text{ V}$	2800		nC	
$R_{Gint}$	$T_j = \text{°C}$	2,5		Ω	
$t_{d(on)}$	$R_{Gon} = 2\text{ Ω}$	$V_{CC} = 600\text{ V}$ $I_{Cnom} = 300\text{ A}$	330		ns
			$T_j = 125\text{ °C}$	50	ns
$E_{on}$	$R_{Goff} = 2\text{ Ω}$	$V_{GE} = \pm 15\text{ V}$	29		mJ
$t_{d(off)}$			650		ns
$t_f$			110		ns
$E_{off}$			48		mJ
$R_{th(j-c)}$	per IGBT			0,08	K/W



**SEMITRANS® 3**

## Trench IGBT Module

**SKM 400GB126D**

**SKM 400GAL126D**

Preliminary Data

### Features

- Homogeneous Si
- Trench = Trenchgate technology
- $V_{CEsat}$  with positive temperature coefficient
- High short circuit capability, self limiting to  $6 \times I_c$

### Typical Applications

- AC inverter drives
- UPS
- Electronic welders

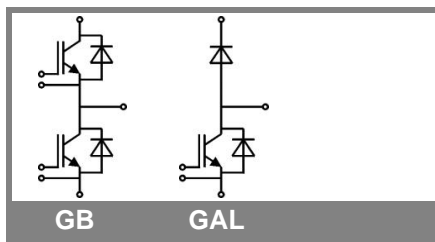

Characteristics					
Symbol	Conditions	min.	typ.	max.	Units
<b>Inverse Diode</b>					
$V_F = V_{EC}$	$I_{Fnom} = 300 \text{ A}; V_{GE} = 0 \text{ V}$	$T_j = 25 \text{ }^\circ\text{C}_{chiplev.}$	1,6	1,8	V
		$T_j = 125 \text{ }^\circ\text{C}_{chiplev.}$	1,6	1,8	V
$V_{F0}$		$T_j = 25 \text{ }^\circ\text{C}$	1	1,1	V
		$T_j = 125 \text{ }^\circ\text{C}$	0,8	0,9	V
$r_F$		$T_j = 25 \text{ }^\circ\text{C}$	2	2,3	mΩ
		$T_j = 125 \text{ }^\circ\text{C}$	2,7	3	mΩ
$I_{RRM}$	$I_{Fnom} = 300 \text{ A}$	$T_j = 125 \text{ }^\circ\text{C}$	390		A
$Q_{rr}$	$di/dt = 6300 \text{ A}/\mu\text{s}$		77		μC
$E_{off}$	$V_{GE} = -15 \text{ V}; V_{CC} = 600 \text{ V}$		27		mJ
$R_{th(j-c)D}$	per diode			0,18	K/W
<b>Freewheeling Diode</b>					
$V_F = V_{EC}$	$I_{Fnom} = 300 \text{ A}; V_{GE} = 0 \text{ V}$	$T_j = 25 \text{ }^\circ\text{C}_{chiplev.}$	1,6	1,8	V
		$T_j = 125 \text{ }^\circ\text{C}_{chiplev.}$	1,6	1,8	V
$V_{F0}$		$T_j = 25 \text{ }^\circ\text{C}$	1	1,1	V
		$T_j = 125 \text{ }^\circ\text{C}$	0,8	0,9	V
$r_F$		$T_j = 25 \text{ }^\circ\text{C}$	2	2,3	V
		$T_j = 125 \text{ }^\circ\text{C}$	2,7	3	V
$I_{RRM}$	$I_{Fnom} = 300 \text{ A}$	$T_j = 125 \text{ }^\circ\text{C}$	390		A
$Q_{rr}$	$di/dt = 6300 \text{ A}/\mu\text{s}$		77		μC
$E_{off}$	$V_{GE} = -15 \text{ V}; V_{CC} = 600 \text{ V}$		27		mJ
$R_{th(j-c)D}$	per diode			0,18	K/W
<b>Module</b>					
$L_{CE}$			15	20	nH
$R_{CC'+EE'}$	res., terminal-chip	$T_{case} = 25 \text{ }^\circ\text{C}$	0,35		mΩ
		$T_{case} = 125 \text{ }^\circ\text{C}$	0,5		mΩ
$R_{th(c-s)}$	per module			0,038	K/W
$M_s$	to heat sink M6		3	5	Nm
$M_t$	to terminals M6		2,5	5	Nm
w				325	g

This is an electrostatic discharge sensitive device (ESDS), international standard IEC 60747-1, Chapter IX.

This technical information specifies semiconductor devices but promises no characteristics. No warranty or guarantee expressed or implied is made regarding delivery, performance or suitability.

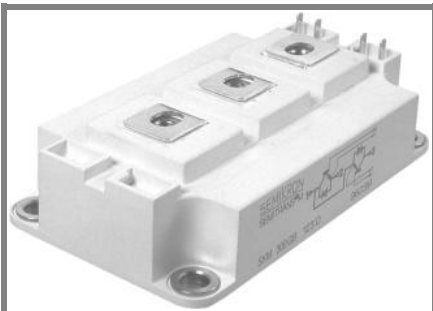

**SEMITRANS® 3**

## Trench IGBT Module

**SKM 400GB126D**

**SKM 400GAL126D**

Preliminary Data

### Features

- Homogeneous Si
- Trench = Trenchgate technology
- $V_{CEsat}$  with positive temperature coefficient
- High short circuit capability, self limiting to  $6 \times I_c$

### Typical Applications

- AC inverter drives
- UPS
- Electronic welders

$Z_{th}$		Conditions	Values	Units
<b><math>Z_{th(j-c)I}</math></b>				
$R_{\theta j-c}$		$i = 1$	55	mk/W
$R_{\theta j-c}$		$i = 2$	21	mk/W
$R_{\theta j-c}$		$i = 3$	3,6	mk/W
$R_{\theta j-c}$		$i = 4$	0,4	mk/W
$\tau_{\theta j-c}$		$i = 1$	0,0393	s
$\tau_{\theta j-c}$		$i = 2$	0,0171	s
$\tau_{\theta j-c}$		$i = 3$	0,002	s
$\tau_{\theta j-c}$		$i = 4$	0,0002	s
<b><math>Z_{th(j-c)D}</math></b>				
$R_{\theta j-cD}$		$i = 1$	120	mk/W
$R_{\theta j-cD}$		$i = 2$	48	mk/W
$R_{\theta j-cD}$		$i = 3$	10	mk/W
$R_{\theta j-cD}$		$i = 4$	2	mk/W
$\tau_{\theta j-cD}$		$i = 1$	0,0262	s
$\tau_{\theta j-cD}$		$i = 2$	0,0417	s
$\tau_{\theta j-cD}$		$i = 3$	0,0012	s
$\tau_{\theta j-cD}$		$i = 4$	0,001	s

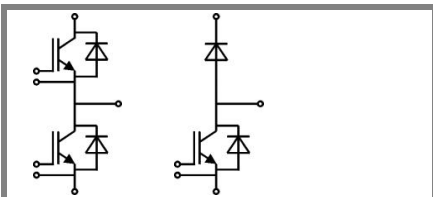

GB

GAL

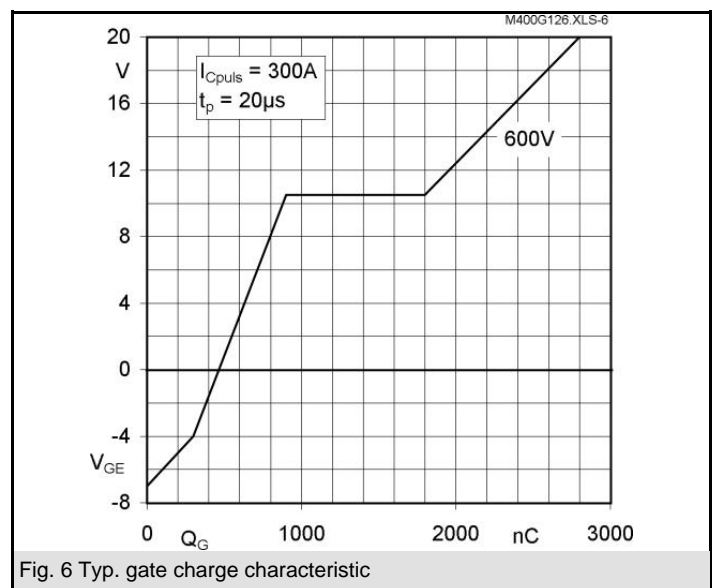
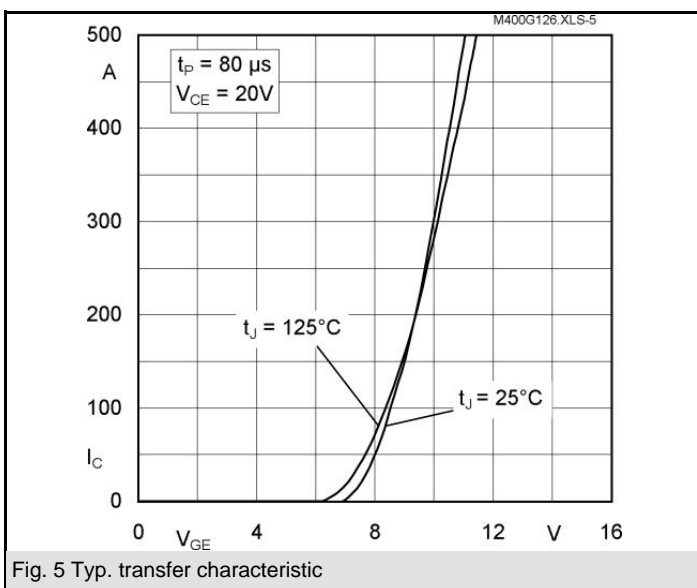
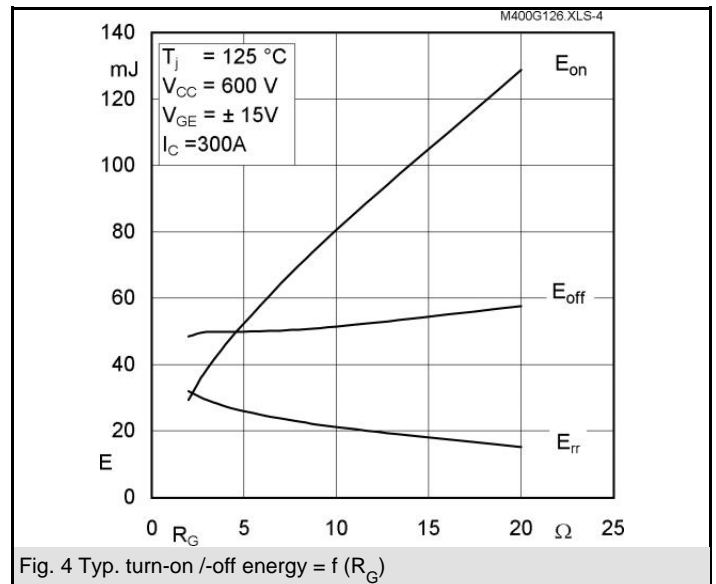
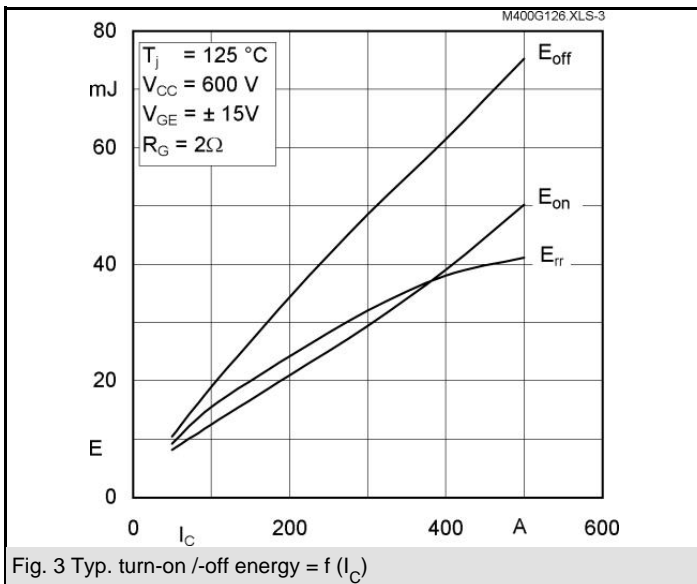
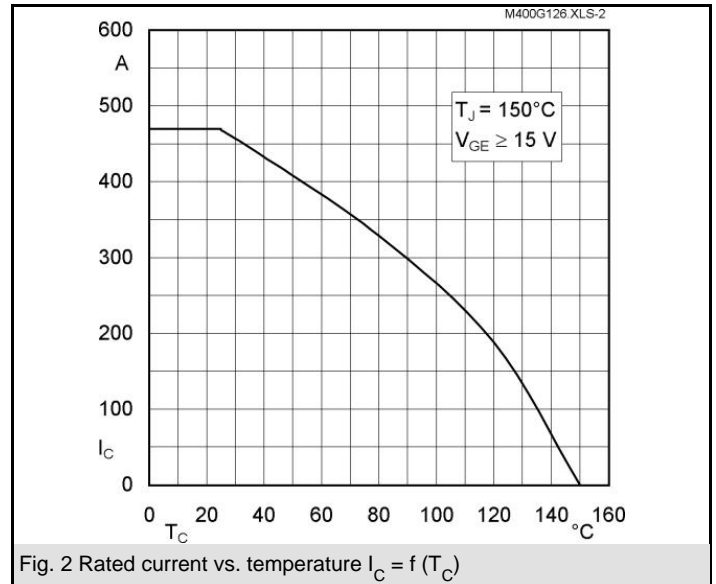
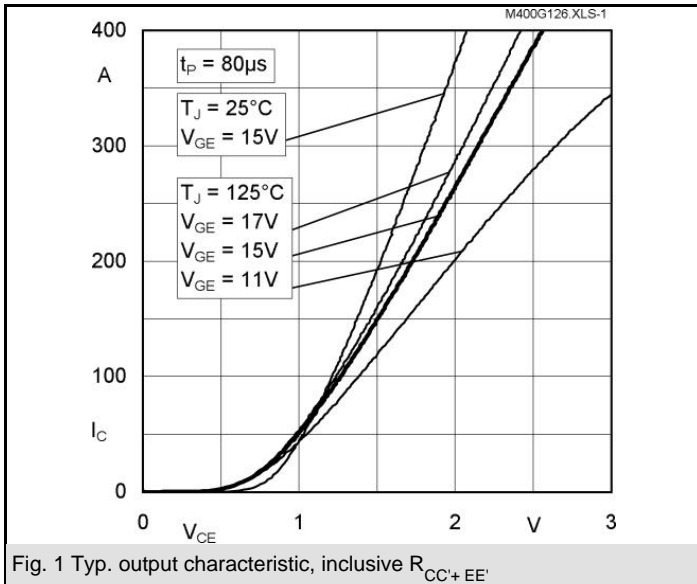

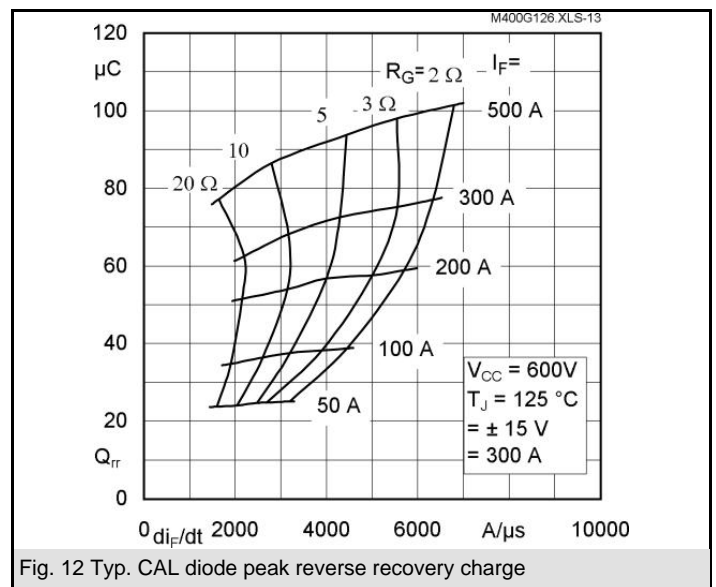
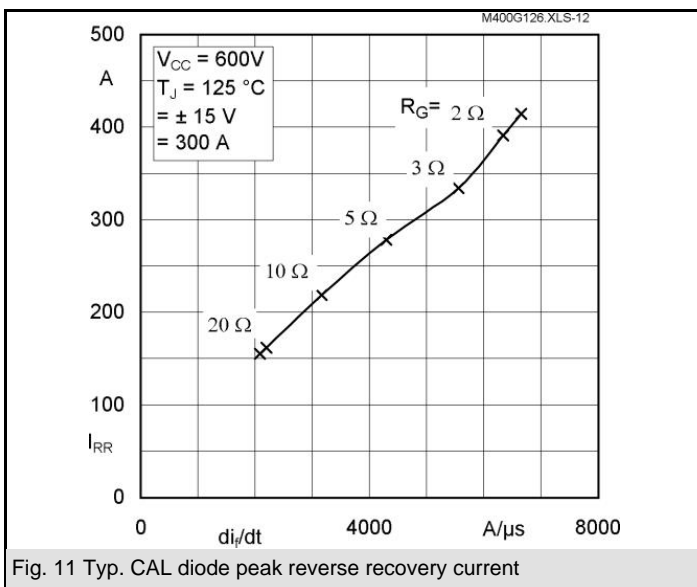
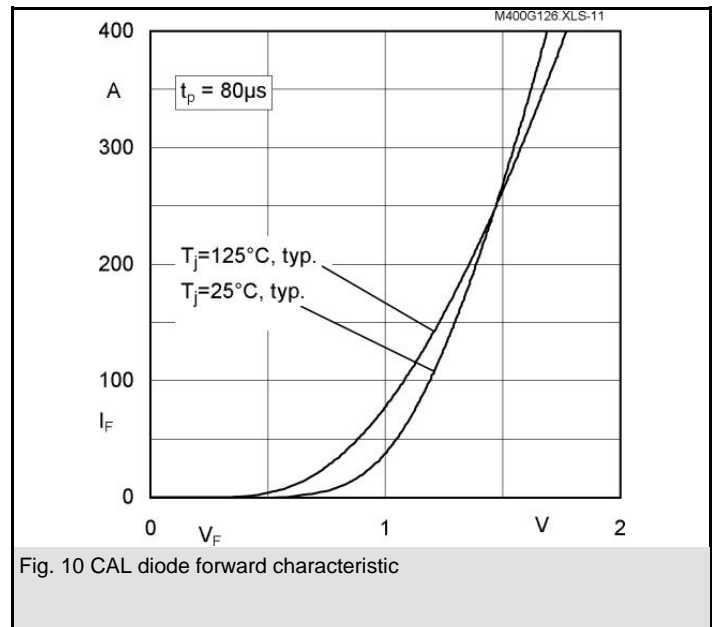
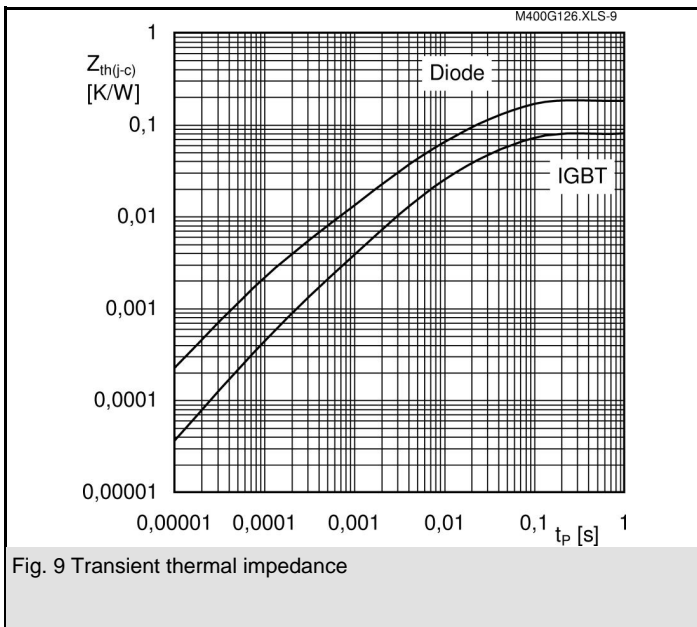
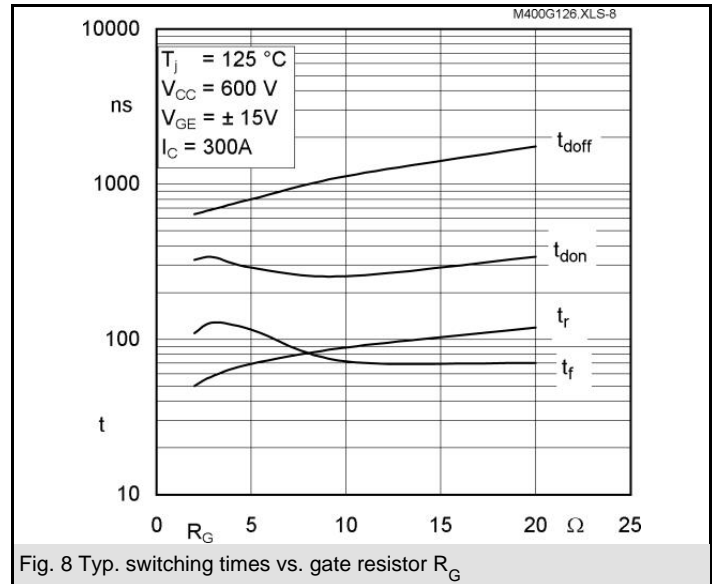
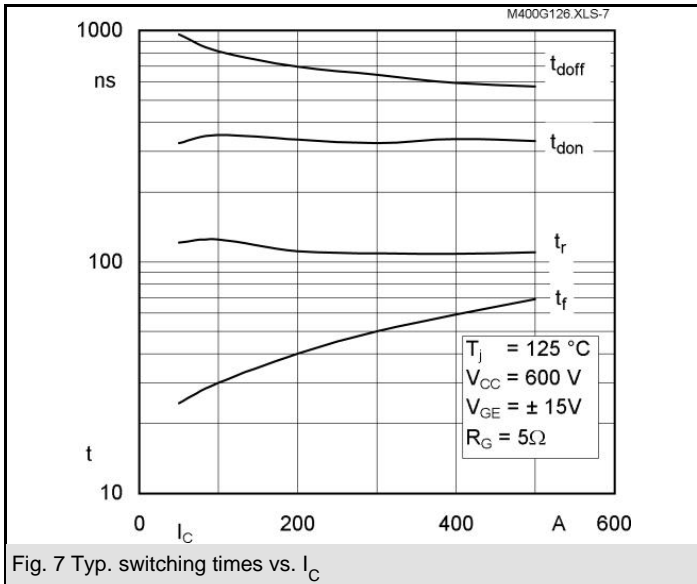

# SKM 400GB126D ...

UL Recognized  
File no. E 63 532

Dimensions in mm

CASED56

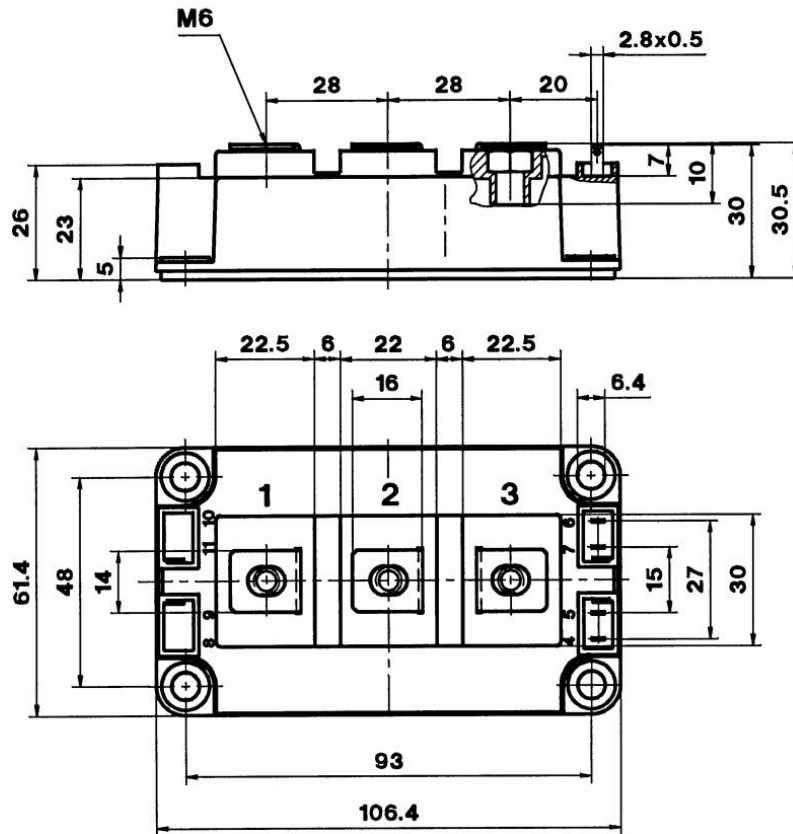

Case D 56

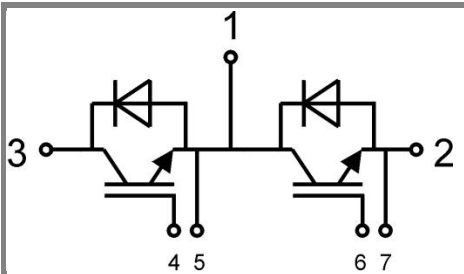

GB Case D 56

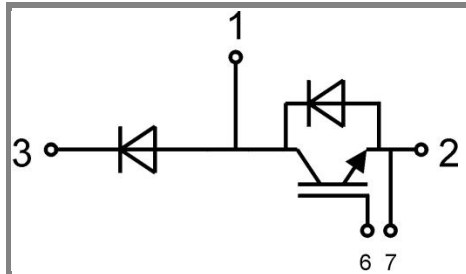

GAL Case D 57 (→ D 56)