

E10976

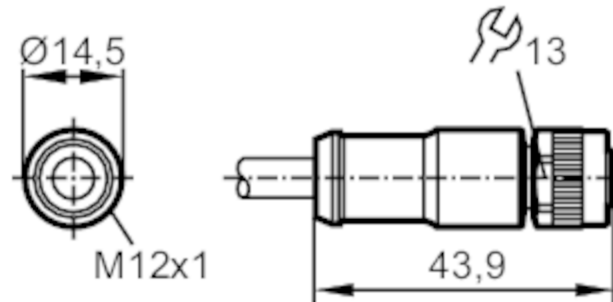

Connecting cable with socket

ADOGH080MSS0005A06



Electrical data

Operating voltage	[V]	< 60 AC/DC
Max. current load total	[A]	2

Operating conditions

Ambient temperature	[°C]	-25...85
Protection		IP 68

Mechanical data

Weight	[g]	245.8
Dimensions	[mm]	14.5 x 14.5 x 43.9
Materials		TPU
Material nut		diecast zinc, nickel-plated

Remarks

Pack quantity		1 pcs.
---------------	--	--------

Electrical connection

Cable: 5 m, PUR, black, Ø 6 mm; 6 x 0.34 mm² (42 x Ø 0.1 mm)

Electrical connection - socket

Connector: 1 x M12, straight; Moulded body: TPU; Locking: diecast zinc, nickel-plated



E10976



Connecting cable with socket

ADOGH080MSS0005A06

Connection

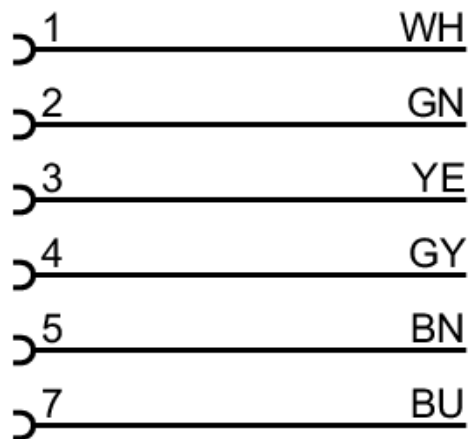

Core colours :

BN =	brown
BU =	blue
GN =	green
GY =	grey
WH =	white
YE =	yellow